

NCP4543

ecoSwitch™ Advanced Load Management Controlled Load Switch with Low R_{ON}

The NCP4543 load switch provides a component and area-reducing solution for efficient power domain switching with inrush current limit via soft start. It is designed to integrate control and driver functionality with a high performance low on-resistance power MOSFET in a single device. This cost effective solution is ideal for power management and hot-swap applications requiring low power consumption in a small footprint.

Features

- Advanced Controller with Charge Pump
- Integrated N-Channel MOSFET with ESD Protection
- Soft-Start via Adjustable Slew Rate Control
- Low On-Resistance
- Input Voltage Range 0.5 V to 6 V
- Low Standby Current
- Load Bleed Function
- No External Components Required
- Enable Pins with CMOS Input Levels
- This is a Pb-Free Device

Typical Applications

- Notebook and Tablet Computers
- Handheld Electronics
- Digital Cameras
- Portable Medical Devices
- Hard Drives
- Peripheral Ports

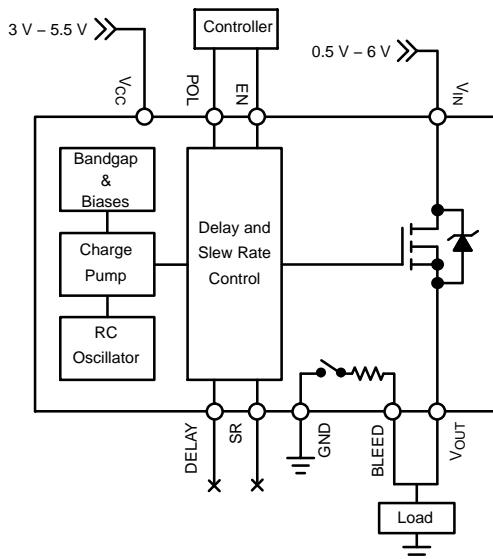

Figure 1. Typical Application – No external components included



ON Semiconductor®

www.onsemi.com

R _{ON} TYP	V _{CC}	V _{IN}	I _{MAX}
10.2 mΩ	5.0 V	1.8 V	7.3 A
12.2 mΩ	3.3 V	5.0 V	



QFN18, 3x3
CASE 485BF

MARKING DIAGRAM

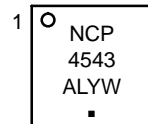

- A = Assembly Location
- L = Wafer Lot
- Y = Year
- W = Work Week
- = Pb-Free Package

PIN CONFIGURATION

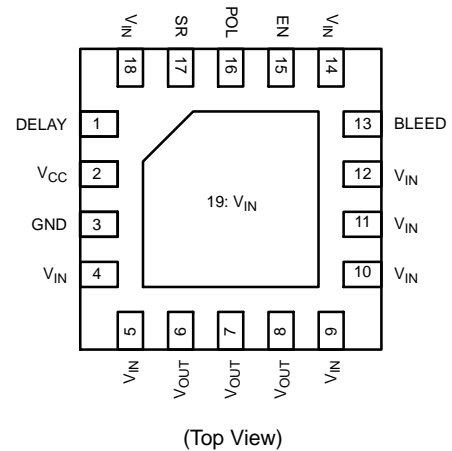

ORDERING INFORMATION

Device	Package	Shipping†
NCP4543IMN5RG-A	QFN18 (Pb-Free)	3000 / Tape & Reel

†For information on tape and reel specifications, including part orientation and tape sizes, please refer to our Tape and Reel Packaging Specifications Brochure, BRD8011/D.

NCP4543

PIN DESCRIPTION

Pin	Name	Function															
1	DELAY	Turn-on delay adjustment															
2	V _{CC}	Supply voltage to controller (3.0 V – 5.5 V)															
3	GND	Controller ground															
4, 5, 9–12, 14, 18, 19	V _{IN}	Drain of MOSFET (0.5 V – 6.0 V)															
6–8	V _{OUT}	Source of MOSFET connected to load															
13	BLEED	Load bleed connection															
15	EN	Digital input used to turn on the MOSFET according to this truth table: <table border="1" style="margin-left: 20px;"> <thead> <tr> <th>EN</th> <th>POL</th> <th>MOSFET</th> </tr> </thead> <tbody> <tr> <td>0</td> <td>0</td> <td>On</td> </tr> <tr> <td>0</td> <td>1</td> <td>Off</td> </tr> <tr> <td>1</td> <td>0</td> <td>Off</td> </tr> <tr> <td>1</td> <td>1</td> <td>On</td> </tr> </tbody> </table>	EN	POL	MOSFET	0	0	On	0	1	Off	1	0	Off	1	1	On
EN	POL	MOSFET															
0	0	On															
0	1	Off															
1	0	Off															
1	1	On															
16	POL	EN has an internal pull down resistor to GND POL has an internal pull up resistor to V _{CC}															
17	SR	Slew rate adjustment															

ABSOLUTE MAXIMUM RATINGS

Rating	Symbol	Value	Unit
Supply Voltage Range	V _{CC}	–0.3 to 6	V
Input Voltage Range	V _{IN}	–0.3 to 6	V
Output Voltage Range	V _{OUT}	–0.3 to 6	V
EN/POL Digital Input Range	V _{EN}	–0.3 to (V _{CC} + 0.3)	V
Thermal Resistance, Junction-to-Air (Note 1)	R _{θJA}	49.5	°C/W
Thermal Resistance, Junction-to-Air (Note 2)	R _{θJA}	32.9	°C/W
Thermal Resistance, Junction-to-Case (V _{IN} Paddle)	R _{θJC}	3.6	°C/W
Continuous MOSFET Current (Note 3)	I _{MAX}	7.3	A
Total Power Dissipation @ T _A = 25°C (Notes 1 and 4) Derate above T _A = 25°C	P _D	1.31 20.2	W mW/°C
Total Power Dissipation @ T _A = 25°C (Notes 2 and 4) Derate above T _A = 25°C	P _D	1.98 30.4	W mW/°C
Storage Temperature Range	T _{STG}	–40 to 150	°C
Lead Temperature, Soldering (10 sec.)	T _{SLD}	260	°C
ESD Capability, Human Body Model (Note 5)	ESD _{HBM}	3.5	kV
ESD Capability, Machine Model (Note 5)	ESD _{MM}	200	V
ESD Capability, Charged Device Model (Note 5)	ESD _{CDM}	1	kV
Latch-up Current Immunity (Note 5)	LU	100	mA

Stresses exceeding those listed in the Maximum Ratings table may damage the device. If any of these limits are exceeded, device functionality should not be assumed, damage may occur and reliability may be affected.

- Surface-mounted on FR4 board using the minimum recommended pad size, 1 oz Cu.
- Surface-mounted on FR4 board using 1 sq-in pad, 1 oz Cu.
- Current limited by package.
- Specified for derating purposes only, ensure that I_{MAX} is never exceeded.
- Tested by the following methods @ T_A = 25°C:
 ESD Human Body Model tested per AEC-Q100-002 (EIA/JESD22-A114)
 ESD Machine Model tested per EIA/JESD22-A115
 ESD Charged Device Model per ESD-STM5.3.1-1999
 Latch-up Current Maximum Rating: ≤100 mA per JEDEC standard: JESD78

NCP4543

RECOMMENDED OPERATING RANGES

Rating	Symbol	Min	Max	Unit
Supply Voltage	V_{CC}	3	5.5	V
Input Voltage	V_{IN}	0.5	6	V
Ground	GND		0	V
Ambient Temperature	T_A	0	70	°C
Junction Temperature	T_J	0	90	°C

Functional operation above the stresses listed in the Recommended Operating Ranges is not implied. Extended exposure to stresses beyond the Recommended Operating Ranges limits may affect device reliability.

ELECTRICAL CHARACTERISTICS ($T_J = 25^\circ\text{C}$ unless otherwise specified)

Parameter	Test Conditions	Symbol	Min	Typ	Max	Unit
-----------	-----------------	--------	-----	-----	-----	------

MOSFET

On-Resistance	$V_{CC} = 5.0\text{ V}; V_{IN} = 1.8\text{ V}$	R_{ON}		10.2	13	m Ω
	$V_{CC} = 5.0\text{ V}; V_{IN} = 5.0\text{ V}$			10.5	13.5	
	$V_{CC} = 3.3\text{ V}; V_{IN} = 1.8\text{ V}$			11	14	
	$V_{CC} = 3.3\text{ V}; V_{IN} = 5.0\text{ V}$			12.2	16	
Leakage Current (Note 6)	$V_{EN} = 0\text{ V}; V_{POL} = V_{CC}; V_{IN} = 6\text{ V}$	I_{LEAK}		0.02	1.0	μA

CONTROLLER

Supply Standby Current (Note 7)	$V_{EN} = 0\text{ V}; V_{POL} = V_{CC} = 5.5\text{ V}$	I_{STBY}		5.0	15	μA
Supply Dynamic Current (Note 8)	$V_{EN} = V_{POL} = V_{CC}$	I_{DYN}		250	500	μA
Bleed Resistance		R_{BLEED}	50	100	200	Ω
Input High Voltage – EN & POL		V_{IH}	2.0			V
Input Low Voltage – EN & POL		V_{IL}			0.8	V
Pull Down Resistance – EN		R_{PD}	40	100	180	k Ω
Pull Up Resistance – POL		R_{PU}	40	100	180	k Ω

Product parametric performance is indicated in the Electrical Characteristics for the listed test conditions, unless otherwise noted. Product performance may not be indicated by the Electrical Characteristics if operated under different conditions.

6. Average current from V_{IN} to V_{OUT} with MOSFET turned off.

7. Average current from V_{CC} to GND with MOSFET turned off.

8. Average current from V_{CC} to GND after charge up time of MOSFET.

NCP4543

SWITCHING CHARACTERISTICS ($T_J = 25^\circ\text{C}$ unless otherwise specified, Note 9)

Parameter	Test Conditions	Symbol	Min	Typ	Max	Unit
$V_{CC} = 5.0\text{ V}, V_{IN} = 1.8\text{ V}$						
Output Slew Rate	$R_L = 10\ \Omega, C_L = 0.1\ \mu\text{F}$	SR		8.1		kV/s
Output Turn-on Delay	$R_L = 10\ \Omega, C_L = 0.1\ \mu\text{F}$	T_{ON}		540		μs
Output Turn-off Delay	$R_L = 10\ \Omega, C_L = 0.1\ \mu\text{F}$	T_{OFF}		1.2		μs
$V_{CC} = 3.3\text{ V}, V_{IN} = 5.0\text{ V}$						
Output Slew Rate	$R_L = 10\ \Omega, C_L = 0.1\ \mu\text{F}$	SR		8.5		kV/s
Output Turn-on Delay	$R_L = 10\ \Omega, C_L = 0.1\ \mu\text{F}$	T_{ON}		670		μs
Output Turn-off Delay	$R_L = 10\ \Omega, C_L = 0.1\ \mu\text{F}$	T_{OFF}		0.8		μs

9. See below figure for Test Circuit and Timing Diagrams.

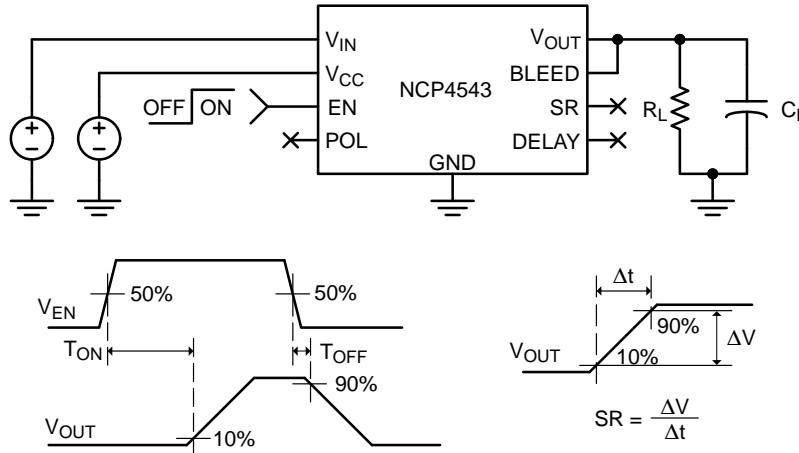

Figure 2. Test Circuit and Timing Diagrams

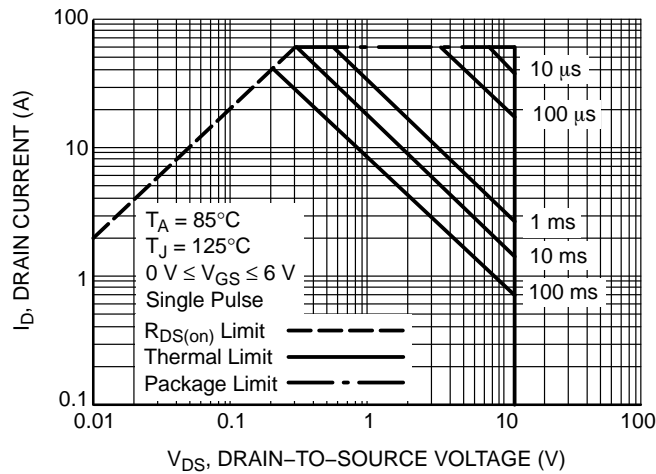

Figure 3. Maximum Rated Forward Biased Safe Operating Area

TYPICAL CHARACTERISTICS

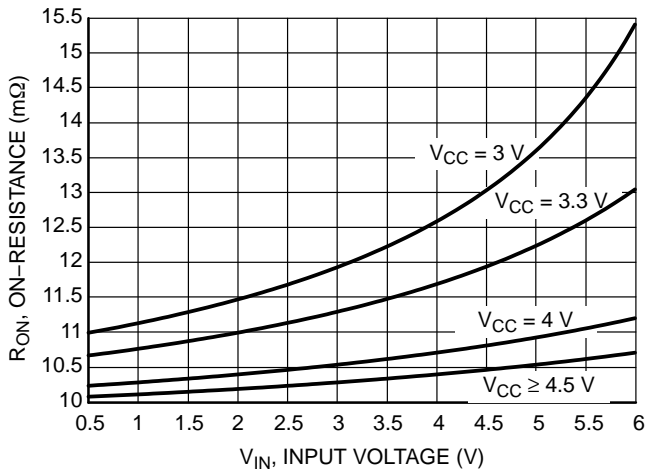

Figure 4. On-Resistance vs. Input Voltage

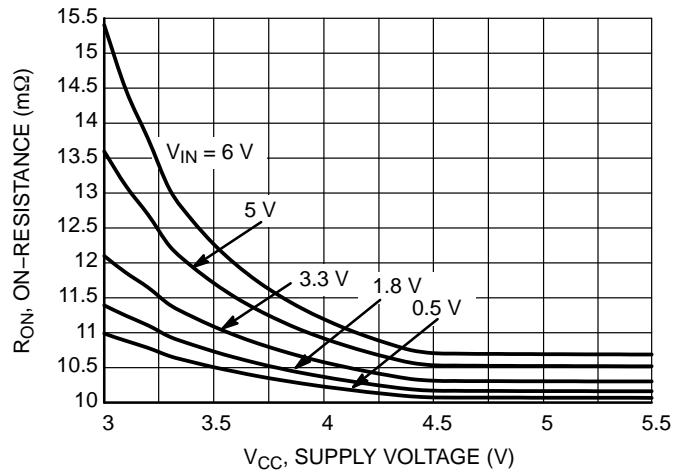

Figure 5. On-Resistance vs. Supply Voltage

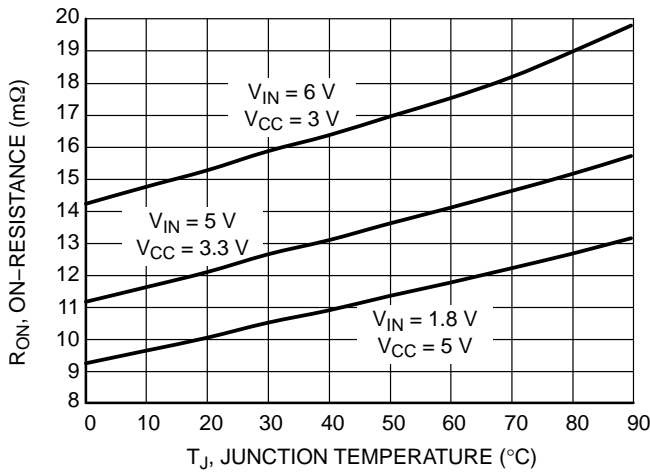

Figure 6. On-Resistance vs. Temperature

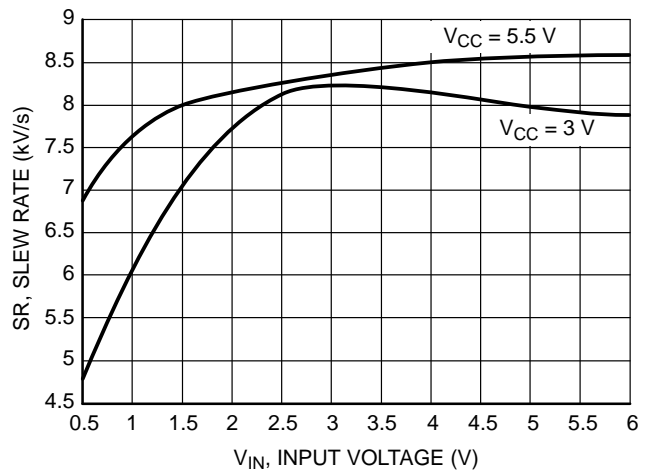

Figure 7. Slew Rate vs. Input Voltage

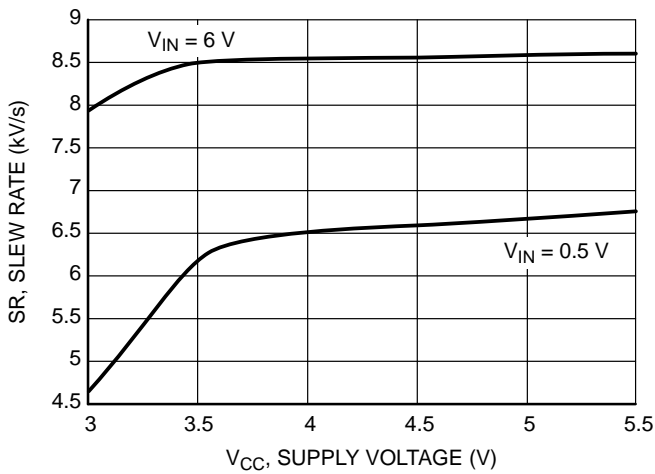

Figure 8. Slew Rate vs. Supply Voltage

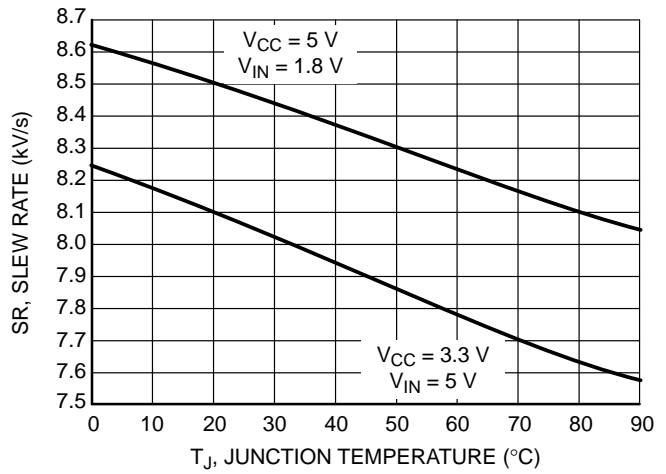

Figure 9. Slew Rate vs. Temperature

TYPICAL CHARACTERISTICS

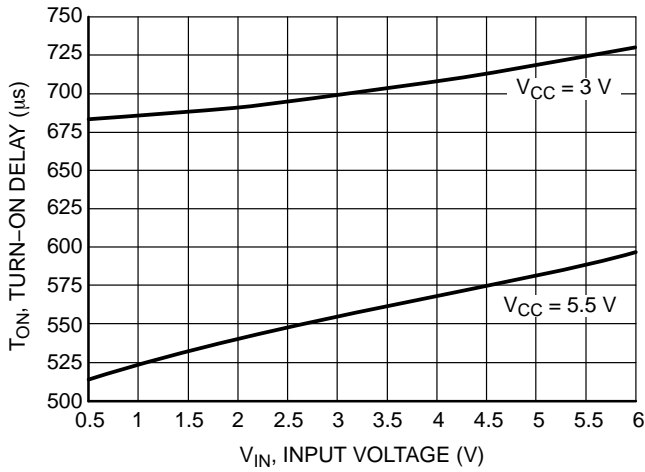

Figure 10. Turn-On Delay vs. Input Voltage

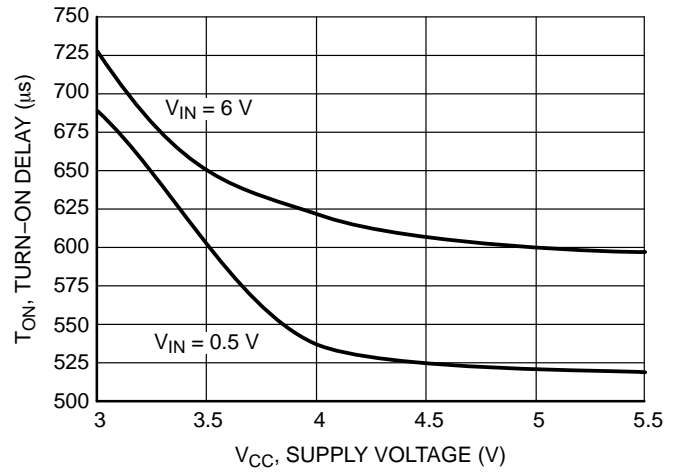

Figure 11. Turn-On Delay vs. Supply Voltage

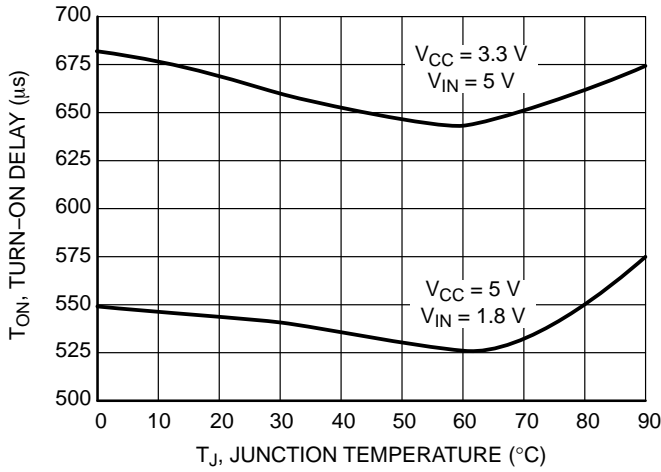

Figure 12. Turn-On Delay vs. Temperature

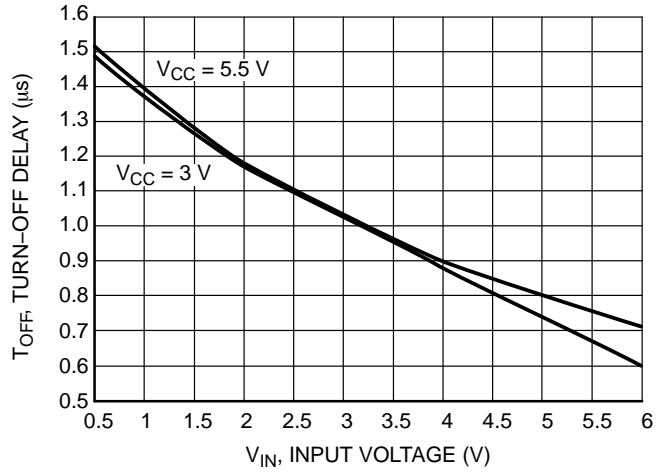

Figure 13. Turn-Off Delay vs. Input Voltage

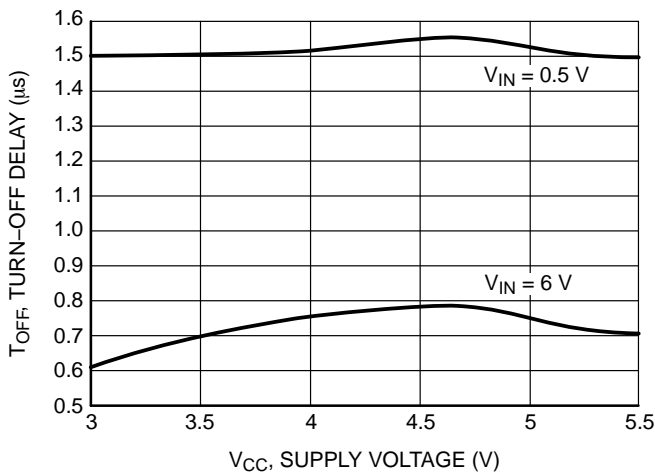

Figure 14. Turn-Off Delay vs. Supply Voltage

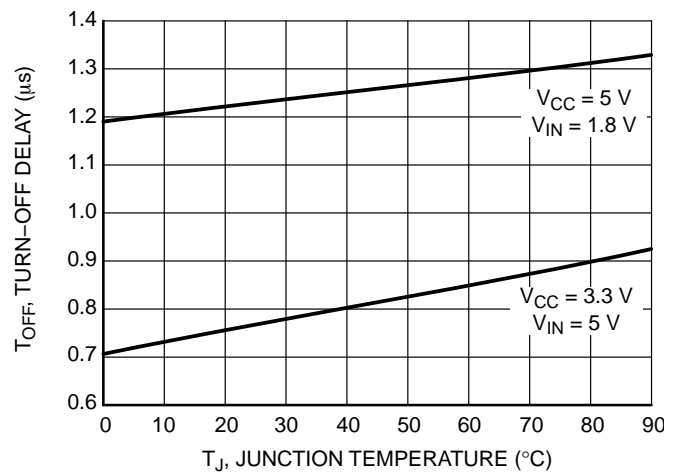

Figure 15. Turn-Off Delay vs. Temperature

NCP4543

TYPICAL CHARACTERISTICS

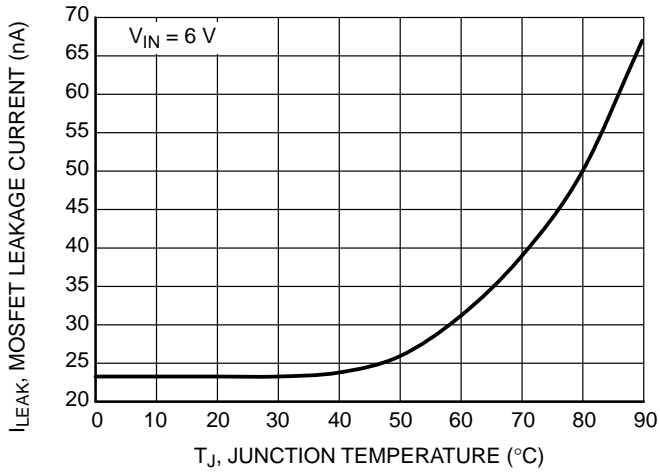

Figure 16. MOSFET Leakage Current vs. Temperature

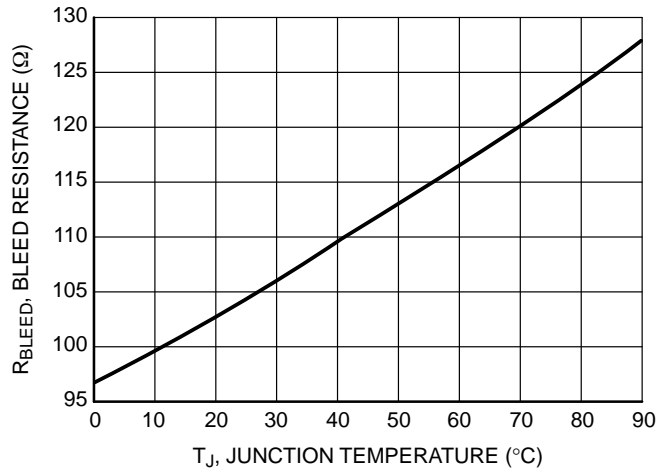

Figure 17. Bleed Resistance vs. Temperature

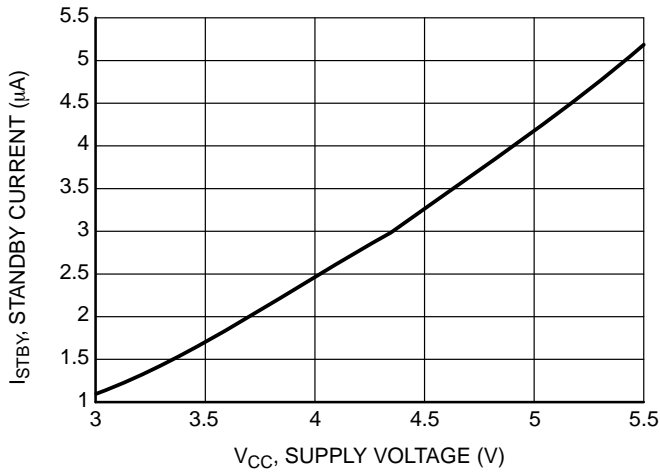

Figure 18. Standby Current vs. Supply Voltage

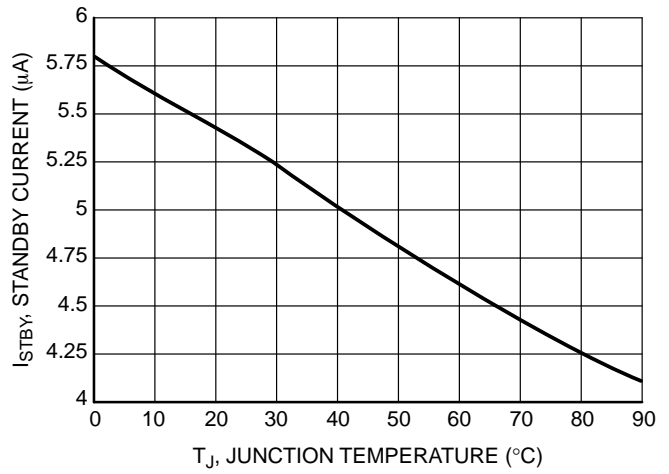

Figure 19. Standby Current vs. Temperature

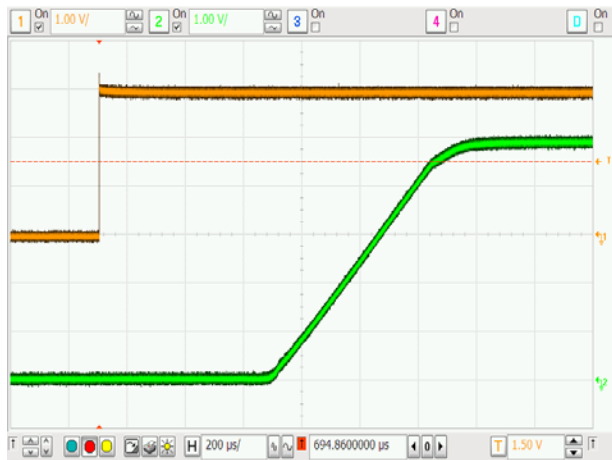

Figure 20. Turn-on Response
(V_{CC} = 3.3 V, V_{IN} = 5.0 V, R_L = 10 Ω, C_L = 0.1 μF)

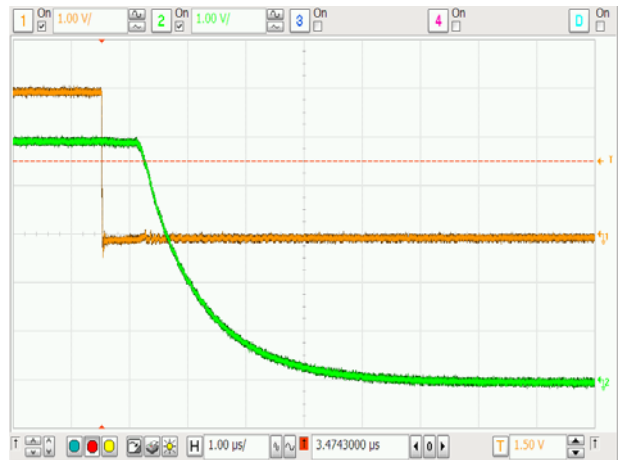

Figure 21. Turn-off Response
(V_{CC} = 3.3 V, V_{IN} = 5.0 V, R_L = 10 Ω, C_L = 0.1 μF)

APPLICATIONS INFORMATION

On-Resistance

The MOSFET gate voltage in the NCP4543 is driven by a charge pump in the controller circuit. The output voltage of the charge pump is dependent on the voltage on V_{CC}. The R_{ON} of the MOSFET is in turn dependent on its V_{GS}. Care must be taken to ensure a sufficient V_{CC} voltage is used to create the desired R_{ON} given the anticipated input voltage.

Enable Control

The NCP4543 allows for enabling the MOSFET in either an active-high or active-low configuration. When the EN and POL pins are both at a logic high level or both at a logic low level and the V_{CC} supply pin has an adequate voltage applied, the MOSFET will be enabled. Similarly, when the EN and POL pins are at different logic levels, the MOSFET will be disabled.

An internal pull down resistor on the EN pin and an internal pull up resistor on the POL pin ensure that the MOSFET will be disabled when neither pin is driven. The internal pull down or pull up resistor can also be used to allow for only one of the pins to be driven in either an active-high or active-low state.

Parametric Adjustments

The NCP4543 can be used in several configurations depending on the need to control turn-on delay, slew rate, and bleed resistance. Default minimum values of each parameter are built into the part without the requirement of external components. This configuration is shown above in Figure 1.

Figures 22 and 23 show alternate configurations where external components are used to modify the turn-on delay, slew rate, and total bleed resistance.

Figure 22 shows an external capacitor, C_{COMBO}, connected from the V_{OUT} pin to both the DELAY and SR pins. This allows for one external capacitor to be used to modify the turn-on delay and slew rate. Note that the value of C_{COMBO} is used in Equations 1 and 2 (below) in place of C_{DEL} and C_{SR} respectively.

Figure 23 shows the use of two external capacitors for independent control of the turn-on delay and slew rate.

Turn-On Delay

The NCP4543 provides a time delay between the input transitions on EN (or POL) to the MOSFET turning on. The

turn-on delay can be increased with an external capacitor added between the DELAY pin and either ground or the V_{OUT} pin as shown in Figures 22 and 23.

The total delay is calculated by adding the default turn-on delay to a delta term which is calculated as follows:

$$\Delta t = K_{DEL} * C_{DEL} \quad (eq. 1)$$

where K_{DEL} is a constant and C_{DEL} is the off-chip capacitance added between the DELAY pin to either ground or the V_{OUT} pin (see table below). When no external capacitor is present, the delay will be the specified default turn-on delay.

Slew Rate Control

The NCP4543 is equipped with controlled output slew rate which provides soft start functionality. This limits the inrush current caused by capacitor charging and enables this device to be used in hot swapping applications. The slew rate can be decreased with an external capacitor added between the SR pin and the V_{OUT} pin as shown in Figures 22 and 23.

The slew rate can be calculated as follows:

$$SR = \frac{K_{SR}}{C_{SR} + C_{CHIP}} \quad (eq. 2)$$

where K_{SR} is a constant, C_{SR} is the off-chip capacitance added between the SR pin and the V_{OUT} pin, and C_{CHIP} is the on-chip capacitance (see table below). Note that this equation is only valid for C_{SR} ≥ 470 pF. When no external capacitor is present, the slew rate will be the specified default slew rate.

Load Bleed

The NCP4543 has an on-chip bleed resistor that can be used to bleed the charge off of the load to ground after the MOSFET has been disabled. In series with the bleed resistor is a bleed switch which is enabled whenever the MOSFET is disabled. Delays are added to the enable of this switch to ensure that both the MOSFET and the bleed switch are not concurrently active. The total bleed resistance can be increased by adding a resistor between the BLEED pin and the V_{OUT} pin as shown in Figures 22 and 23. If the load bleed function is not desired, the BLEED pin should be tied to ground or left floating.

SLEW RATE AND TURN-ON DELAY

Parameter	Conditions	Symbol	Min	Typ	Max	Unit
Turn-on Delay Constant		K _{DEL}		1.74		MΩ
External Delay Capacitance (Note 10)	Between DEL pin and GND	C _{DEL}			10	nF
Slew Rate Constant		K _{SR}		1.4		μA
External Slew Rate Capacitance (Note 10)	Between SR pin and V _{OUT} pin	C _{SR}			2	nF
Internal Slew Rate Capacitance		C _{CHIP}		150		pF
External Combo Capacitance (Note 10)	Between SR & DEL pins and V _{OUT} pin	C _{COMBO}			2	nF

10. Recommended range, larger values may be used but may degrade the performance of the part

NCP4543

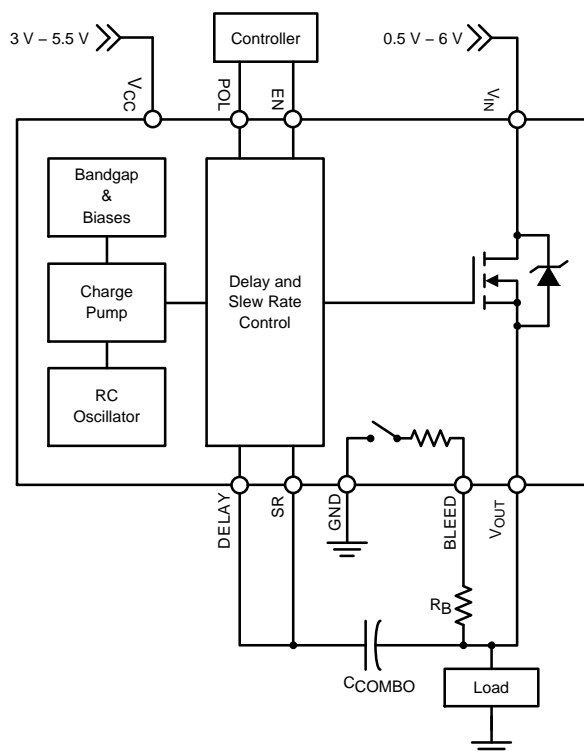

Figure 22. Example Application – External bleed resistor with single-capacitor adjustment of turn-on delay and slew rate.

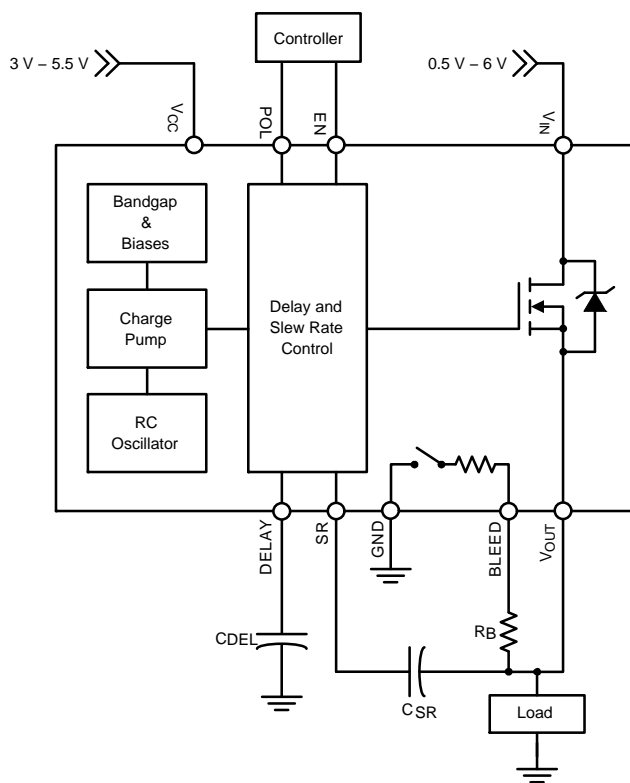

Figure 23. Example Application – External bleed resistor with independent adjustment of turn-on delay and slew rate.

MECHANICAL CASE OUTLINE

PACKAGE DIMENSIONS

ON Semiconductor®



SCALE 2:1

QFN18 3x3, 0.5P
CASE 485BF-01
ISSUE O

DATE 10 FEB 2010

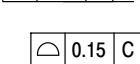
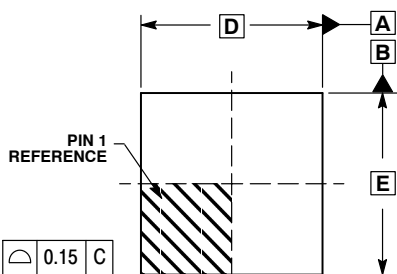

TOP VIEW

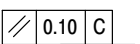

DETAIL B

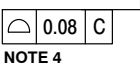

SIDE VIEW

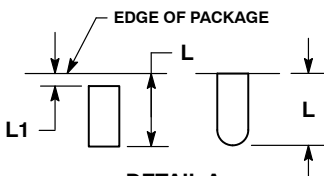

DETAIL A
OPTIONAL
CONSTRUCTION

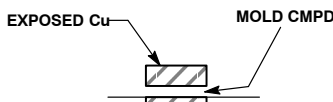

DETAIL B
OPTIONAL
CONSTRUCTION

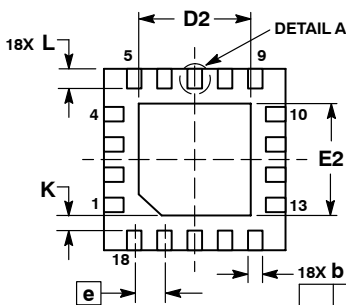

BOTTOM VIEW

0.10	C	A	B
0.05	C		

NOTE 3

NOTES:

1. DIMENSIONS AND TOLERANCING PER ASME Y14.5M, 1994.
2. CONTROLLING DIMENSION: MILLIMETERS.
3. DIMENSION b APPLIES TO PLATED TERMINAL AND IS MEASURED BETWEEN 0.15 AND 0.30 MM FROM TERMINAL.
4. COPLANARITY APPLIES TO THE EXPOSED PAD AS WELL AS THE TERMINALS.

MILLIMETERS		
DIM	MIN	MAX
A	0.80	1.00
A1	0.00	0.05
A3	0.20	REF
b	0.18	0.30
D	3.00	BSC
D2	1.75	1.95
E	3.00	BSC
E2	1.75	1.95
e	0.50	BSC
K	0.20	---
L	0.275	0.375
L1	0.00	0.15

GENERIC MARKING DIAGRAM*

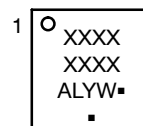

- XXXXX = Specific Device Code
- A = Assembly Location
- L = Wafer Lot
- Y = Year
- W = Work Week
- = Pb-Free Package

(Note: Microdot may be in either location)

*This information is generic. Please refer to device data sheet for actual part marking.
Pb-Free indicator, "G" or microdot "▪", may or may not be present.

RECOMMENDED MOUNTING FOOTPRINT

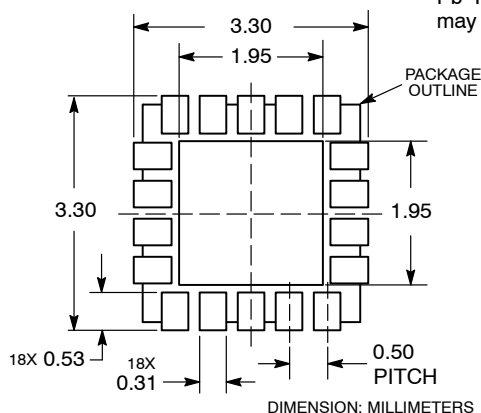

DIMENSION: MILLIMETERS

*For additional information on our Pb-Free strategy and soldering details, please download the ON Semiconductor Soldering and Mounting Techniques Reference Manual, SOLDERRM/D.

DOCUMENT NUMBER:	98AON48573E	Electronic versions are uncontrolled except when accessed directly from the Document Repository. Printed versions are uncontrolled except when stamped "CONTROLLED COPY" in red.
DESCRIPTION:	QFN18 3X3, 0.5P	PAGE 1 OF 1

ON Semiconductor and ON are trademarks of Semiconductor Components Industries, LLC dba ON Semiconductor or its subsidiaries in the United States and/or other countries. ON Semiconductor reserves the right to make changes without further notice to any products herein. ON Semiconductor makes no warranty, representation or guarantee regarding the suitability of its products for any particular purpose, nor does ON Semiconductor assume any liability arising out of the application or use of any product or circuit, and specifically disclaims any and all liability, including without limitation special, consequential or incidental damages. ON Semiconductor does not convey any license under its patent rights nor the rights of others.

onsemi, **Onsemi**, and other names, marks, and brands are registered and/or common law trademarks of Semiconductor Components Industries, LLC dba "**onsemi**" or its affiliates and/or subsidiaries in the United States and/or other countries. **onsemi** owns the rights to a number of patents, trademarks, copyrights, trade secrets, and other intellectual property. A listing of **onsemi**'s product/patent coverage may be accessed at www.onsemi.com/site/pdf/Patent-Marking.pdf. **onsemi** reserves the right to make changes at any time to any products or information herein, without notice. The information herein is provided "as-is" and **onsemi** makes no warranty, representation or guarantee regarding the accuracy of the information, product features, availability, functionality, or suitability of its products for any particular purpose, nor does **onsemi** assume any liability arising out of the application or use of any product or circuit, and specifically disclaims any and all liability, including without limitation special, consequential or incidental damages. Buyer is responsible for its products and applications using **onsemi** products, including compliance with all laws, regulations and safety requirements or standards, regardless of any support or applications information provided by **onsemi**. "Typical" parameters which may be provided in **onsemi** data sheets and/or specifications can and do vary in different applications and actual performance may vary over time. All operating parameters, including "Typicals" must be validated for each customer application by customer's technical experts. **onsemi** does not convey any license under any of its intellectual property rights nor the rights of others. **onsemi** products are not designed, intended, or authorized for use as a critical component in life support systems or any FDA Class 3 medical devices or medical devices with a same or similar classification in a foreign jurisdiction or any devices intended for implantation in the human body. Should Buyer purchase or use **onsemi** products for any such unintended or unauthorized application, Buyer shall indemnify and hold **onsemi** and its officers, employees, subsidiaries, affiliates, and distributors harmless against all claims, costs, damages, and expenses, and reasonable attorney fees arising out of, directly or indirectly, any claim of personal injury or death associated with such unintended or unauthorized use, even if such claim alleges that **onsemi** was negligent regarding the design or manufacture of the part. **onsemi** is an Equal Opportunity/Affirmative Action Employer. This literature is subject to all applicable copyright laws and is not for resale in any manner.

PUBLICATION ORDERING INFORMATION

LITERATURE FULFILLMENT:

Email Requests to: orderlit@onsemi.com

onsemi Website: www.onsemi.com

TECHNICAL SUPPORT

North American Technical Support:
Voice Mail: 1 800-282-9855 Toll Free USA/Canada
Phone: 011 421 33 790 2910

Europe, Middle East and Africa Technical Support:

Phone: 00421 33 790 2910

For additional information, please contact your local Sales Representative

X-ON Electronics

Largest Supplier of Electrical and Electronic Components

Click to view similar products for [Power Switch ICs - Power Distribution](#) *category:*

Click to view products by [ON Semiconductor](#) *manufacturer:*

Other Similar products are found below :

[TCK111G,LF\(S\)](#) [FPF1018](#) [DS1222](#) [TCK2065G,LF](#) [SZNCP3712ASNT3G](#) [MIC2033-05BYMT-T5](#) [MIC2033-12AYMT-T5](#) [MIC2033-05BYM6-T5](#) [SLG5NT1437VTR](#) [SZNCP3712ASNT1G](#) [DML1008LDS-7](#) [KTS1670EDA-TR](#) [KTS1640QGDV-TR](#) [KTS1641QGDV-TR](#) [NCV459MNWTBG](#) [FPF2260ATMX](#) [U6513A](#) [MIC2012YM-TR](#) [NCP45780IMN24RTWG](#) [AP22953CW12-7](#) [MAX14919AUP+T](#) [MAX14919ATP+](#) [KTS1697AEOAB-TR](#) [TCK207AN,LF](#) [BD2227G-LBTR](#) [TCK126BG,LF](#) [XC8111AA010R-G](#) [MPQ5072GG-AEC1-P](#) [TCK128BG,LF](#) [XC8110AA018R-G](#) [XC8110AA010R-G](#) [XC8111AA018R-G](#) [MC33882PEP](#) [TPS2104DBVR](#) [MIC2098-1YMT-TR](#) [MIC94062YMT TR](#) [MP6231DN-LF](#) [MIC2015-1.2YM6 TR](#) [MIC2075-2YM](#) [MIC94068YML-TR](#) [SIP32461DB-T2-GE1](#) [NCP335FCT2G](#) [TCK105G,LF\(S\)](#) [AP2411S-13](#) [AP2151DSG-13](#) [AP2172MPG-13](#) [MIC94094YC6-TR](#) [MIC94093YC6-TR](#) [MIC94064YC6-TR](#) [MIC94061YMT-TR](#)