

# NCP4688

## Voltage Regulator - Low Noise, LDO Linear

### 150 mA

The NCP4688 is a CMOS 150 mA LDO linear voltage regulator with high output voltage accuracy which features a low noise output voltage and high ripple rejection. The low level of output noise 10  $\mu$ Vrms typically is kept at any output voltage. The very common SOT23-5 package and small  $\mu$ DFN 1x1 package are suitable for industrial applications, portable communication equipments and RF modules.

#### Features

- Operating Input Voltage Range: 2 V to 5.25 V
- Output Voltage Range: 1.2 to 4.8 V (available in 0.1 V steps)
- $\pm 1\%$  Output Voltage Accuracy
- Output Noise: 10  $\mu$ Vrms
- Line Regulation: 0.02%/V
- Current Limit Circuit
- High PSRR: 80 dB at 1 kHz, 75 dB at 10 kHz
- Available in SOT-23-5 and  $\mu$ DFN 1.0 x 1.0 mm Package
- These are Pb-Free Devices

#### Typical Applications

- Home Appliances, Industrial Equipment
- Cable Boxes, Satellite Receivers, Entertainment Systems
- Car Audio Equipment, Navigation Systems
- Notebook Adaptors, LCD TVs, Cordless Phones and Private LAN Systems
- RF Modules

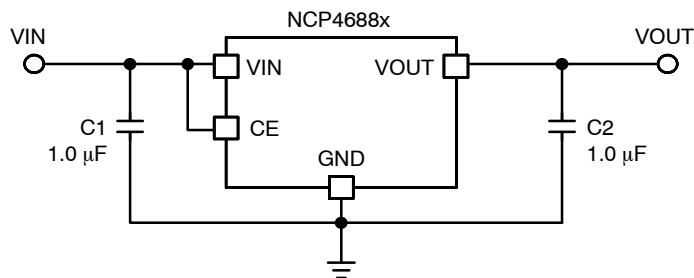

Figure 1. Typical Application Schematic



ON Semiconductor™

<http://onsemi.com>

#### MARKING DIAGRAMS



SOT-23-5  
CASE 1212

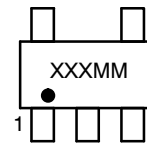

UDFN-4  
CASE 517BR

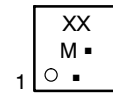

(Top Views)

XX, XXX = Specific Device Code  
M, MM = Date Code  
▪ = Pb-Free Package

(\*Note: Microdot may be in either location)

#### ORDERING INFORMATION

See detailed ordering and shipping information in the package dimensions section on page 12 of this data sheet.

# NCP4688

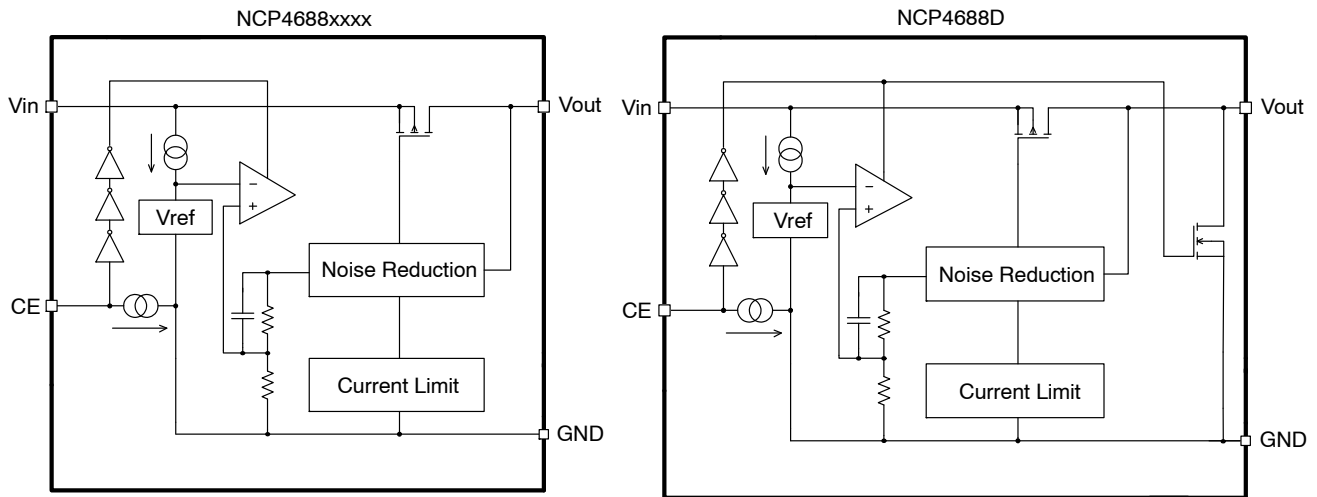

Figure 2. Simplified Schematic Block Diagram

Table 1. PIN FUNCTION DESCRIPTION

| Pin No.<br>SOT-23-5 | Pin No.<br>DFN 1x1 | Pin Name | Description                                    |
|---------------------|--------------------|----------|--|
| 1                   | 4                  | VIN      | Input pin                                      |
| 2                   | 2                  | GND      | Ground pin                                     |
| 3                   | 3                  | CE       | Chip enable pin ("H" active)                   |
| 4                   |                    | NC       | Non connected                                  |
| 5                   | 1                  | VOUT     | Output pin                                     |
|                     | *EP                | EP       | Exposed Pad (leave floating or connect to GND) |

Table 2. ABSOLUTE MAXIMUM RATINGS

| Rating                                    | Symbol      | Value                  | Unit |
|---|-------------|------------------------|------|
| Input Voltage                             | $V_{IN}$    | 0 – 6 V                | V    |
| Output Voltage                            | $V_{OUT}$   | -0.3 to $V_{IN} + 0.3$ | V    |
| Chip Enable Input                         | $V_{CE}$    | 0 – 6 V                | V    |
| Power Dissipation SOT-23-5                | $P_D$       | 420                    | mW   |
| Power Dissipation $\mu$ DFN 1.0 x 1.0 mm  |             | 400                    |      |
| Junction Temperature                      | $T_J$       | -40 to 150             | °C   |
| Storage Temperature                       | $T_{STG}$   | -55 to 125             | °C   |
| ESD Capability, Human Body Model (Note 1) | $ESD_{HBM}$ | 2000                   | V    |
| ESD Capability, Machine Model (Note 1)    | $ESD_{MM}$  | 200                    | V    |

Stresses exceeding Maximum Ratings may damage the device. Maximum Ratings are stress ratings only. Functional operation above the Recommended Operating Conditions is not implied. Extended exposure to stresses above the Recommended Operating Conditions may affect device reliability.

- This device series incorporates ESD protection and is tested by the following methods:  
 ESD Human Body Model tested per AEC-Q100-002 (EIA/JESD22-A114)  
 ESD Machine Model tested per AEC-Q100-003 (EIA/JESD22-A115)  
 Latchup Current Maximum Rating tested per JEDEC standard: JESD78

# NCP4688

**Table 3. THERMAL CHARACTERISTICS**

| Rating  | Symbol          | Value | Unit                        |
|---|-----------------|-------|-----------------------------|
| Thermal Characteristics, SOT-23-5<br>Thermal Resistance, Junction-to-Air                    | $R_{\theta JA}$ | 238   | $^{\circ}\text{C}/\text{W}$ |
| Thermal Characteristics, $\mu\text{DFN } 1 \times 1$<br>Thermal Resistance, Junction-to-Air | $R_{\theta JA}$ | 250   | $^{\circ}\text{C}/\text{W}$ |

**Table 4. ELECTRICAL CHARACTERISTICS**

( $-40^{\circ}\text{C} \leq T_A \leq 85^{\circ}\text{C}$ ;  $C_{IN} = C_{OUT} = 1.0 \mu\text{F}$ , unless otherwise noted. Typical values are at  $T_A = +25^{\circ}\text{C}$ .)

| Parameter                        | Test Conditions   |  | Symbol             | Min    | Typ       | Max             | Unit                       |
|----------------------------------|---|--|--------------------|--------|-----------|-----------------|----------------------------|
| Operating Input Voltage          | $1.2 \text{ V} < V_{\text{out}} < 4.8 \text{ V}$  |  | $V_{\text{IN}}$    | 2.0    |           | 5.25            | V                          |
| Output Voltage                   | $T_a = 25^{\circ}\text{C}$ , $V_{\text{out}} > 2.0 \text{ V}$   |  | $V_{\text{OUT}}$   | x0.99  |           | x1.01           | V                          |
|                                  | $-40^{\circ}\text{C} < T_a < 85^{\circ}\text{C}$ , $V_{\text{out}} > 2.0 \text{ V}$   |  |                    | x0.985 |           | x1.015          | V                          |
|                                  | $T_a = 25^{\circ}\text{C}$ , $V_{\text{out}} \leq 2.0 \text{ V}$  |  |                    | -20    |           | +20             | mV                         |
|                                  | $-40^{\circ}\text{C} < T_a < 85^{\circ}\text{C}$ , $V_{\text{out}} \leq 2.0 \text{ V}$  |  |                    | -30    |           | +30             | mV                         |
| Output Voltage Temp. Coefficient | $-40^{\circ}\text{C} < T_a < 85^{\circ}\text{C}$  |  |                    |        | $\pm 100$ |                 | ppm/ $^{\circ}\text{C}$    |
| Line Regulation                  | Set $V_{\text{out}} + 0.3 < V_{\text{IN}} < 5.25 \text{ V}$   | $V_{\text{out}} > 4.1 \text{ V}$                       | LineReg            |        | 0.02      | 0.10            | %/V                        |
|                                  | Set $V_{\text{out}} + 0.5 < V_{\text{IN}} < 5.0 \text{ V}$  | $1.7 \text{ V} \leq V_{\text{OUT}} < 4.1 \text{ V}$    |                    |        |           |                 |                            |
|                                  | $2.2 < V_{\text{IN}} < 5.0 \text{ V}$   | $V_{\text{out}} < 1.7 \text{ V}$                       |                    |        |           |                 |                            |
| Load Regulation                  | $1 \text{ mA} < I_{\text{OUT}} \leq 150 \text{ mA}$   |  | LoadReg            | -14    | 0         | 14              | mV                         |
| Dropout Voltage                  | $I_{\text{OUT}} = 150 \text{ mA}$   | $1.2 \text{ V} \leq V_{\text{OUT}} < 1.3 \text{ V}$    | $V_{\text{DO}}$    |        | 0.39      | 0.80            | V                          |
|                                  |   | $1.3 \text{ V} \leq V_{\text{OUT}} < 1.4 \text{ V}$    |                    |        | 0.37      | 0.70            |                            |
|                                  |   | $1.4 \text{ V} \leq V_{\text{OUT}} \leq 1.5 \text{ V}$ |                    |        | 0.34      | 0.60            |                            |
|                                  |   | $1.5 \text{ V} \leq V_{\text{OUT}} < 1.7 \text{ V}$    |                    |        | 0.32      | 0.50            |                            |
|                                  |   | $1.7 \text{ V} \leq V_{\text{OUT}} < 2.0 \text{ V}$    |                    |        | 0.29      | 0.41            |                            |
|                                  |   | $2.0 \text{ V} \leq V_{\text{OUT}} < 2.5 \text{ V}$    |                    |        | 0.25      | 0.36            |                            |
|                                  |   | $2.5 \text{ V} \leq V_{\text{OUT}} < 2.8 \text{ V}$    |                    |        | 0.22      | 0.31            |                            |
|                                  |   | $2.8 \text{ V} \leq V_{\text{OUT}} \leq 4.8 \text{ V}$ |                    |        | 0.20      | 0.28            |                            |
| Output Current                   |   |  | $I_{\text{OUT}}$   | 150    |           |                 | mA                         |
| Short Current Limit              | $V_{\text{OUT}} = 0 \text{ V}$  |  | $I_{\text{SC}}$    |        | 40        |                 | mA                         |
| Quiescent Current                | $I_{\text{out}} = 0 \text{ mA}$   | $V_{\text{out}} > 4.1 \text{ V}$                       | $I_{\text{Q}}$     |        | 80        | 100             | $\mu\text{A}$              |
|                                  |   | $V_{\text{out}} \leq 4.1 \text{ V}$                    |                    |        | 75        |                 |                            |
| Standby Current                  | $V_{\text{IN}} = V_{\text{IN max}}$ , $V_{\text{CE}} = 0 \text{ V}$   |  | $I_{\text{STB}}$   |        | 0.1       | 1.0             | $\mu\text{A}$              |
| CE Pin Pull-Down Current         |   |  | $I_{\text{PD}}$    |        | 0.3       | 0.6             | $\mu\text{A}$              |
| CE Pin Threshold Voltage         | CE Input Voltage "H"  |  | $V_{\text{CEH}}$   | 1.0    |           | $V_{\text{IN}}$ | V                          |
|                                  | CE Input Voltage "L"  |  | $V_{\text{CEL}}$   |        |           | 0.4             |                            |
| Power Supply Rejection Ratio     | $V_{\text{OUT}} > 4.1 \text{ V}$ @ $V_{\text{IN}} = 5.25 \text{ V}$ ,<br>$V_{\text{OUT}} \leq 4.1 \text{ V}$ @ $V_{\text{IN}} =$<br>Set $V_{\text{OUT}} + 1.0 \text{ V}$ ,<br>$\Delta V_{\text{IN\_PK-PK}} = 0.2 \text{ V}$ ,<br>$I_{\text{OUT}} = 30 \text{ mA}$ | $f = 1 \text{ kHz}$                                    | PSRR               |        | 80        |                 | dB                         |
|                                  |   | $f = 10 \text{ kHz}$                                   |                    |        | 75        |                 |                            |
|                                  |   | $f = 100 \text{ kHz}$                                  |                    |        | 65        |                 |                            |
| Output Noise Voltage             | $I_{\text{OUT}} = 30 \text{ mA}$ , $f = 10 \text{ Hz}$ to $100 \text{ kHz}$   |  | $V_{\text{NOISE}}$ |        | 10        |                 | $\mu\text{V}_{\text{rms}}$ |
| Autodischarge NMOS Resistance    | $V_{\text{IN}} = 4.0 \text{ V}$ , $V_{\text{CE}} = 0.0 \text{ V}$   |  | $R_{\text{DSON}}$  |        | 60        |                 | ohm                        |

# NCP4688

## TYPICAL CHARACTERISTICS

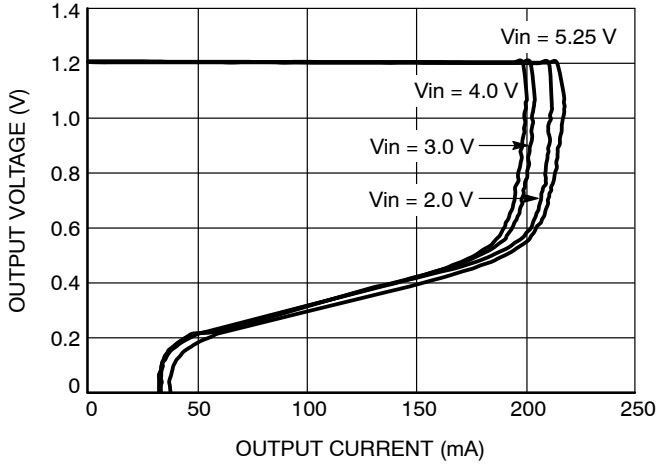

Figure 3. Output Voltage vs. Output Current  
NCP4688xx12

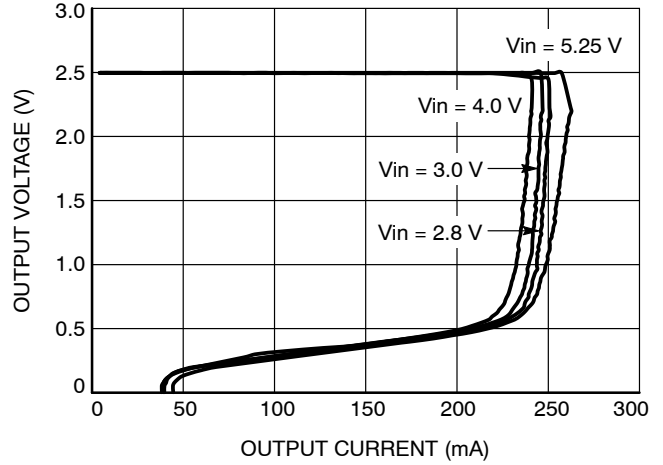

Figure 4. Output Voltage vs. Output Current  
NCP4688xx25

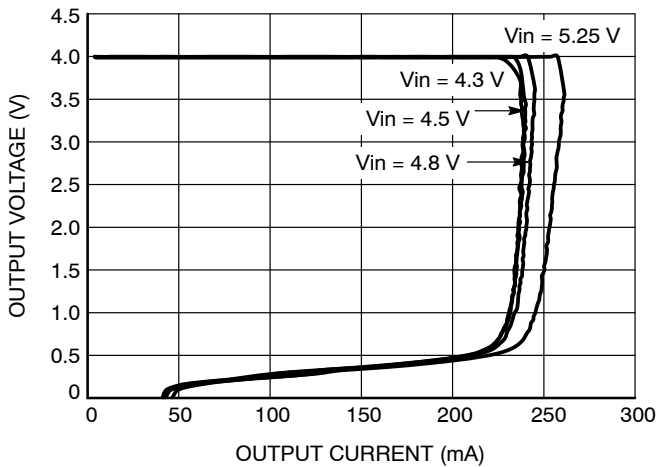

Figure 5. Output Voltage vs. Output Current  
NCP4688xx40

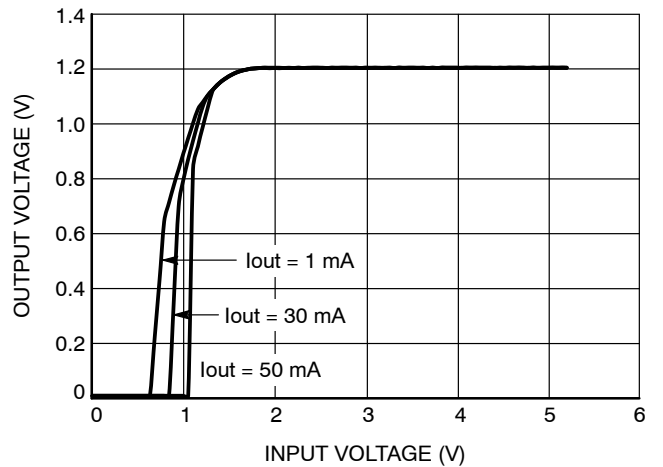

Figure 6. Output Voltage vs. Input Voltage  
NCP4688xx12

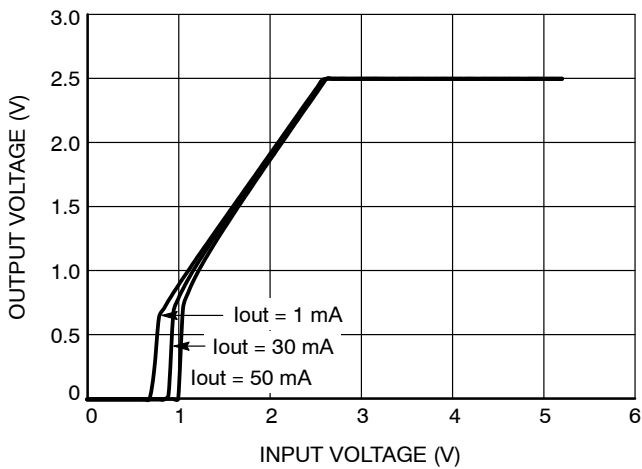

Figure 7. Output Voltage vs. Input Voltage  
NCP4688xx25

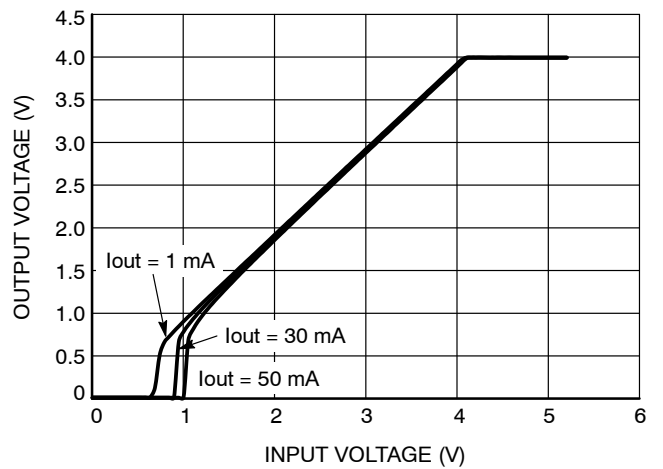

Figure 8. Output Voltage vs. Input Voltage  
NCP4688xx40

# NCP4688

## TYPICAL CHARACTERISTICS

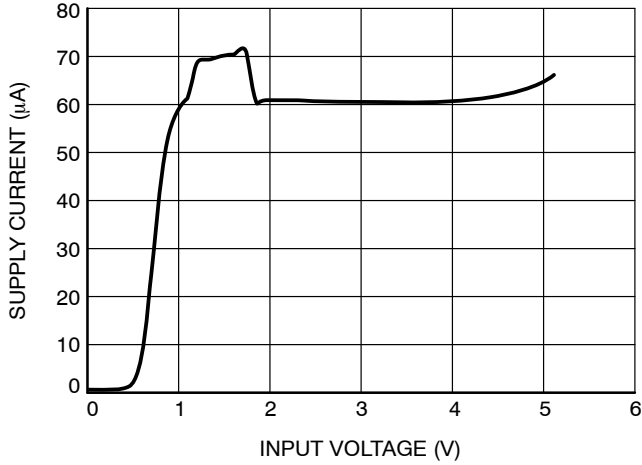

Figure 9. Supply Current vs. Input Voltage  
NCP4688xx12

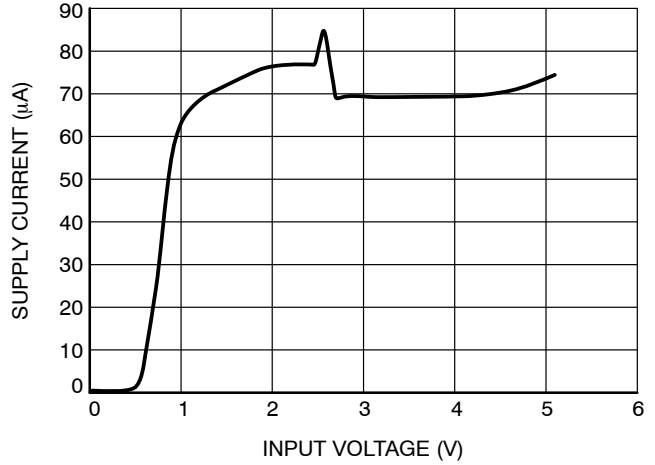

Figure 10. Supply Current vs. Input Voltage  
NCP4688xx25

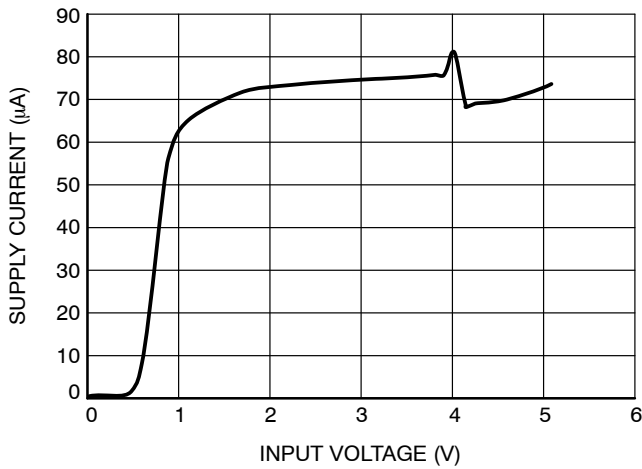

Figure 11. Supply Current vs. Input Voltage  
NCP4688xx40

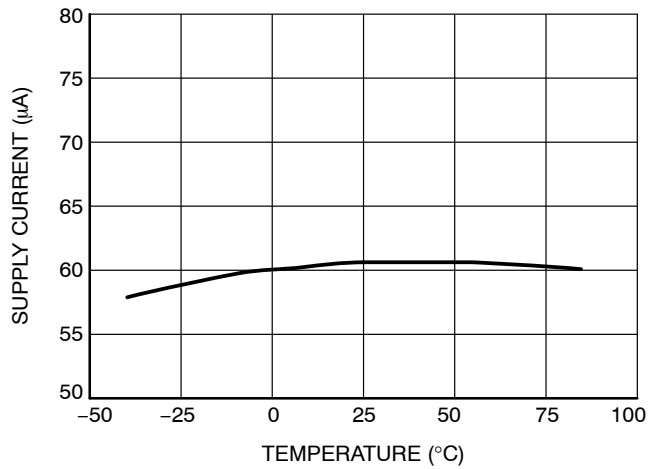

Figure 12. Supply Current vs. Temperature  
NCP4688xx12

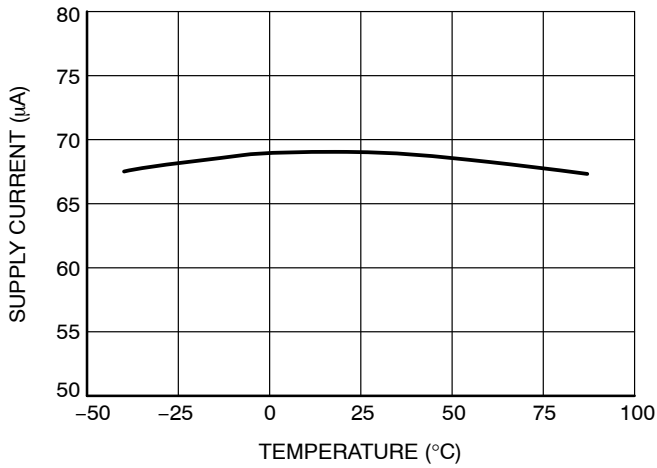

Figure 13. Supply Current vs. Temperature  
NCP4688xx25

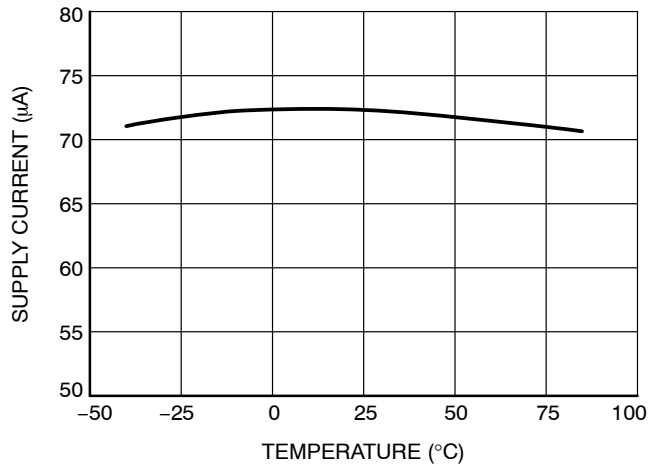

Figure 14. Supply Current vs. Temperature  
NCP4688xx40

# NCP4688

## TYPICAL CHARACTERISTICS

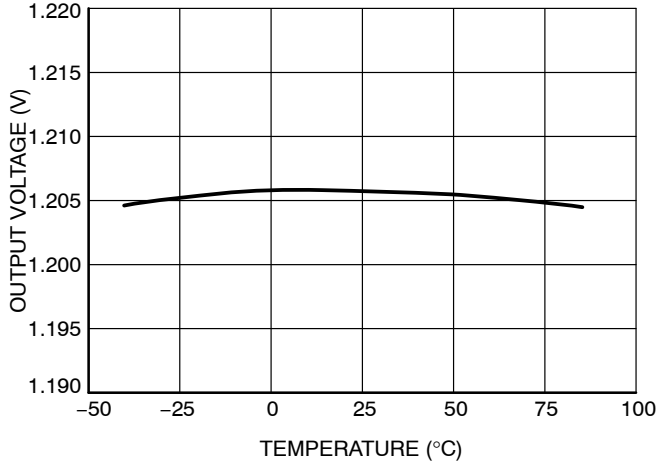

Figure 15. Output Voltage vs. Temperature  
NCP4688xx12

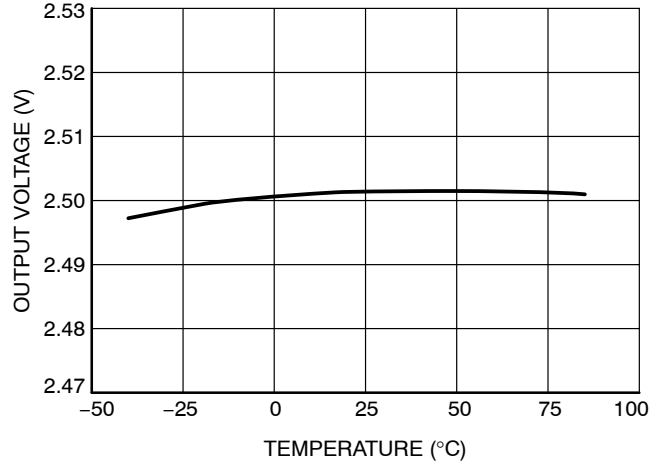

Figure 16. Output Voltage vs. Temperature  
NCP4688xx25

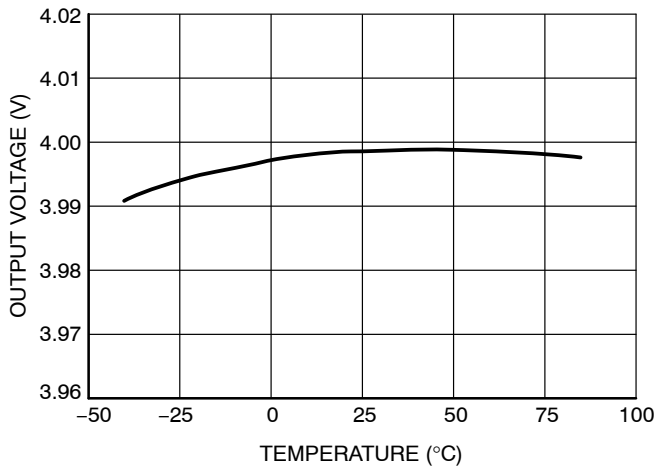

Figure 17. Output Voltage vs. Temperature  
NCP4688xx40

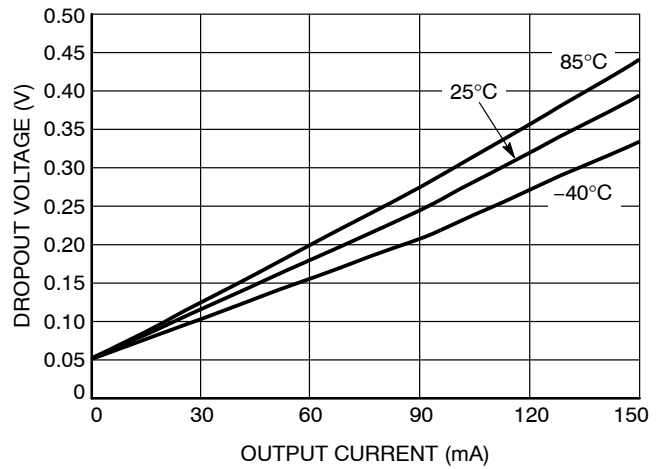

Figure 18. Dropout Voltage vs. Output Current  
NCP4688xx12

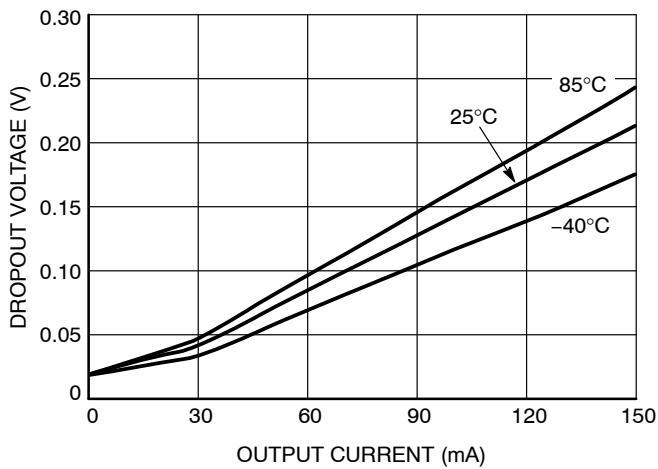

Figure 19. Dropout Voltage vs. Output Current  
NCP4688xx25

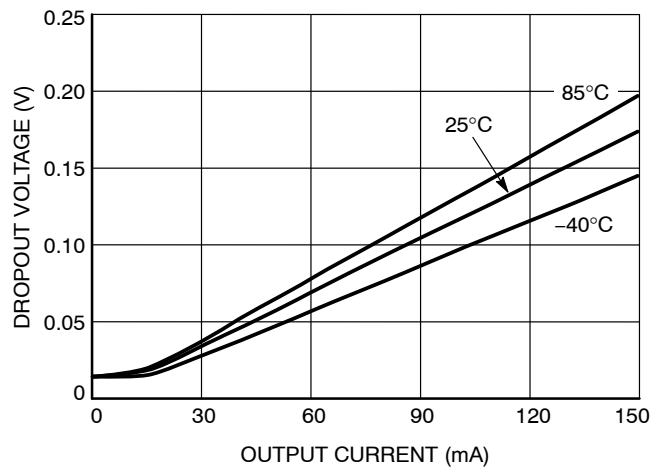

Figure 20. Dropout Voltage vs. Output Current  
NCP4688xx40

# NCP4688

## TYPICAL CHARACTERISTICS

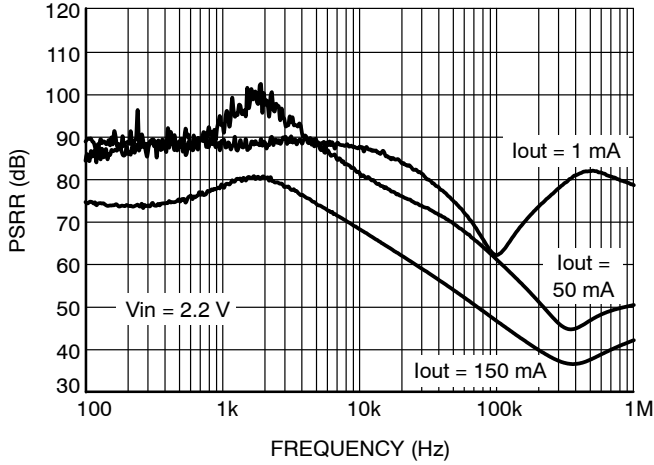

Figure 21. PSRR vs. Frequency NCP4688xx12

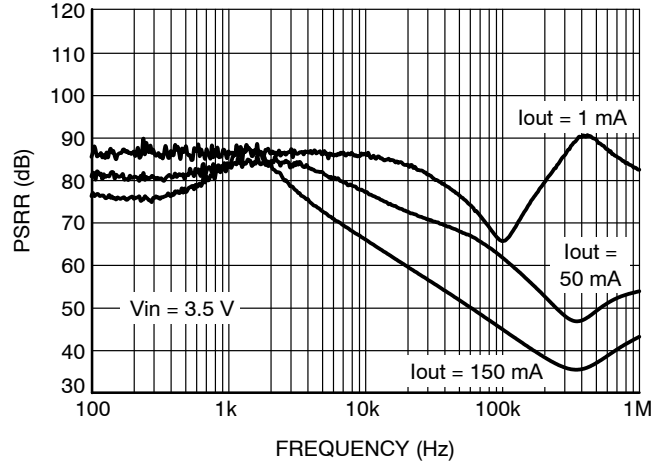

Figure 22. PSRR vs. Frequency NCP4688xx25

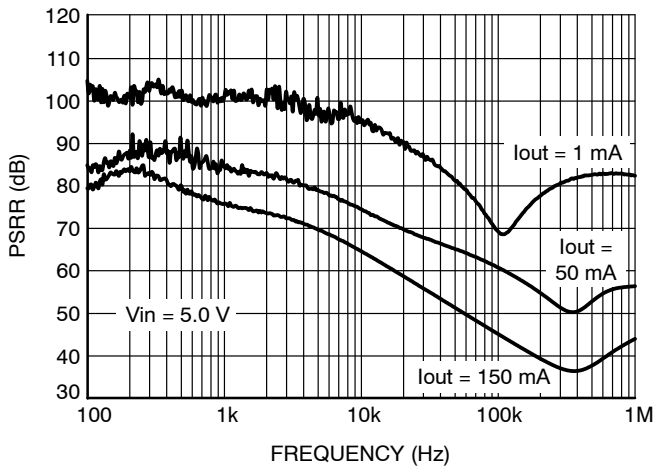

Figure 23. PSRR vs. Frequency NCP4688xx40

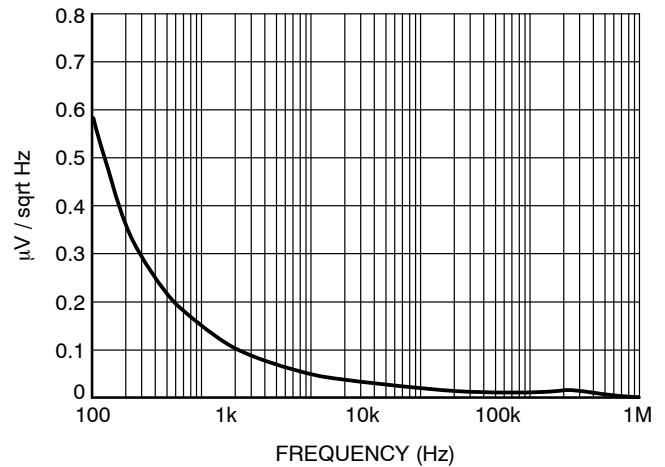

Figure 24. Output Noise Density vs. Frequency NCP4688xx12

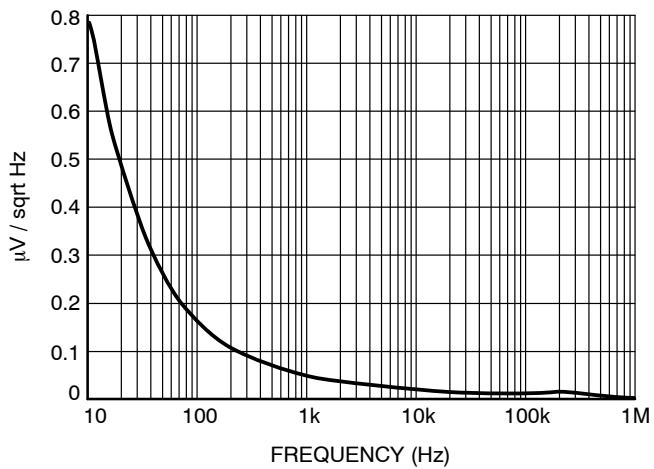

Figure 25. Output Noise Density vs. Frequency NCP4688xx25

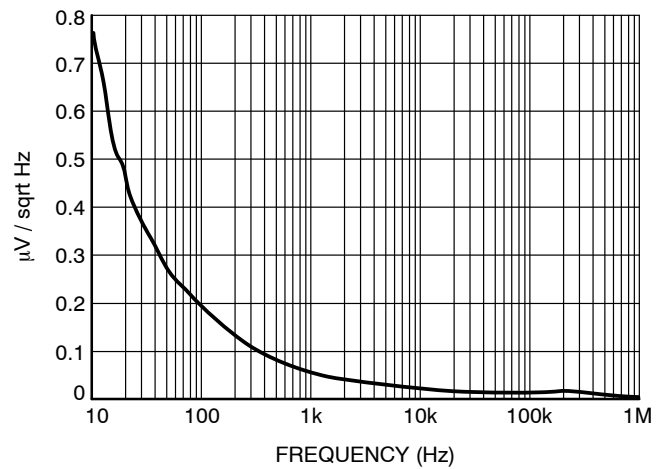
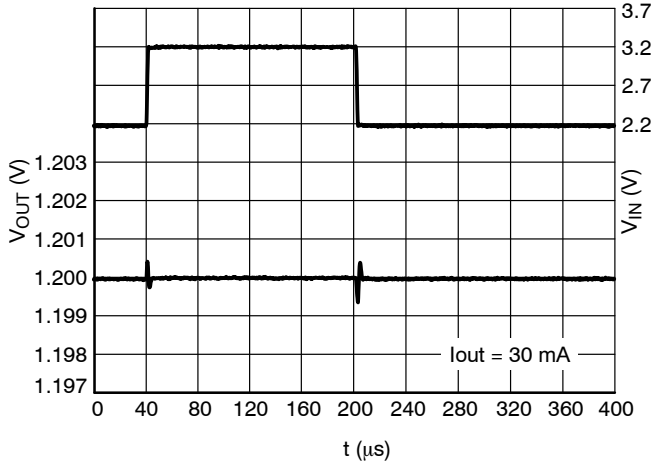

Figure 26. Output Noise Density vs. Frequency NCP4688xx40

# NCP4688

## TYPICAL CHARACTERISTICS



**Figure 27. Line Transient Response  
NCP4688xx12**

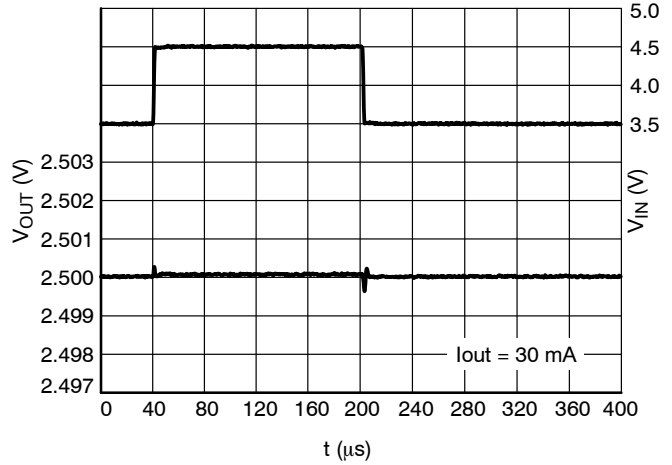

**Figure 28. Line Transient Response  
NCP4688xx25**

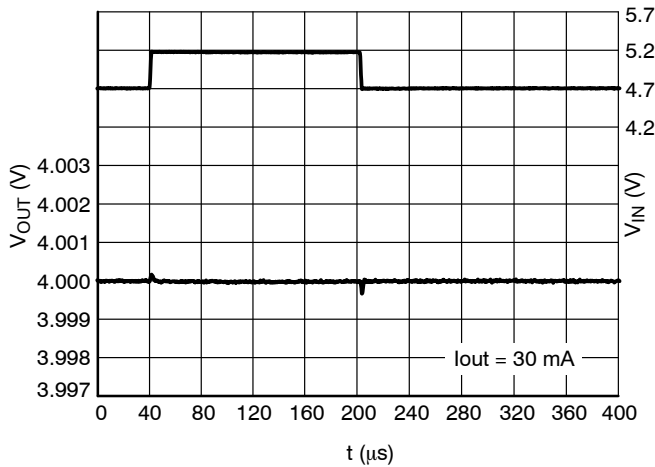

**Figure 29. Line Transient Response  
NCP4688xx40**

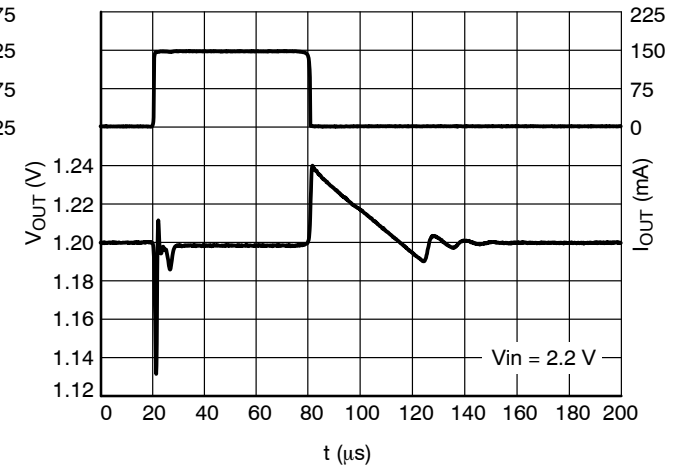

**Figure 30. Load Transient Response Load  
Step 1 mA to 150 mA NCP4688xx12**

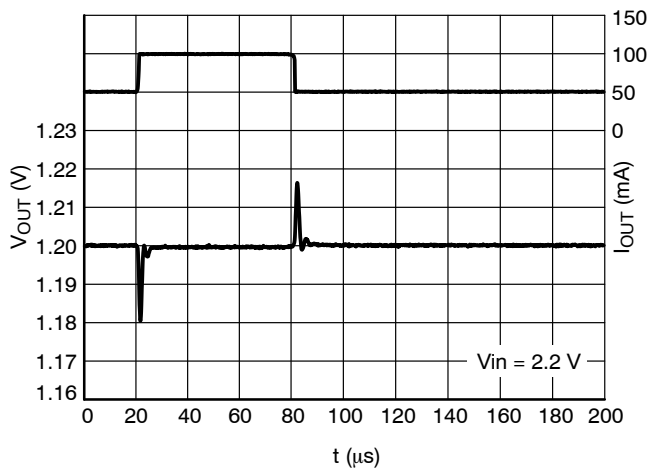

**Figure 31. Load Transient Response Load  
Step 50 mA to 100 mA NCP4688xx12**

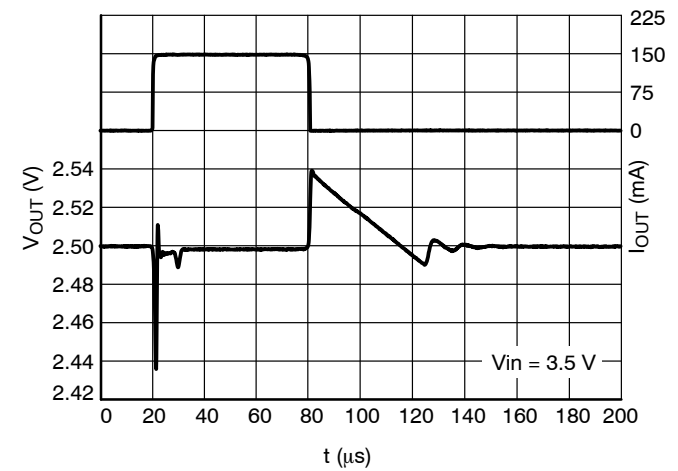
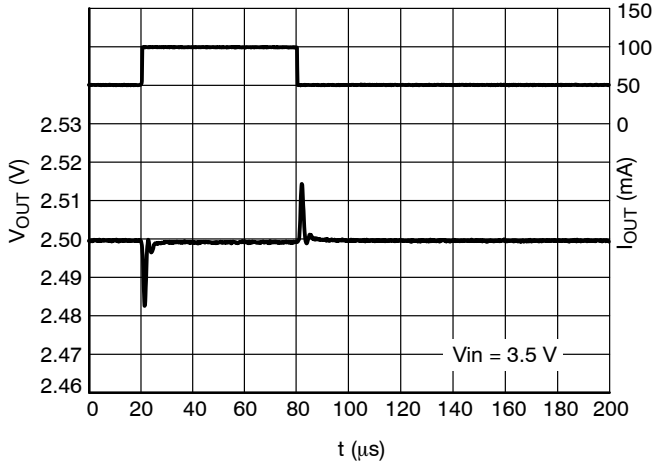

**Figure 32. Load Transient Response Load  
Step 1 mA to 150 mA NCP4688xx25**



# NCP4688

## TYPICAL CHARACTERISTICS



**Figure 33. Load Transient Response Load Step 50 mA to 100 mA NCP4688xx25**

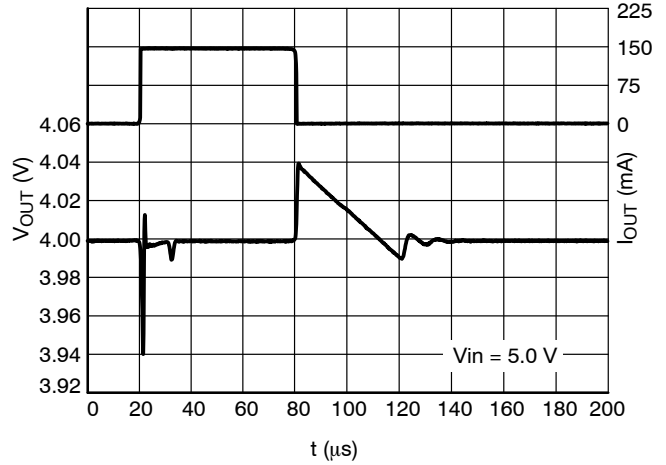

**Figure 34. Load Transient Response Load Step 1 mA to 150 mA NCP4688xx40**

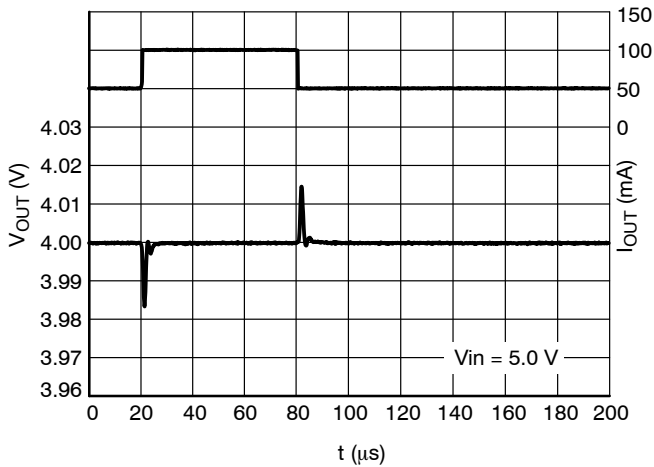

**Figure 35. Load Transient Response Load Step 50 mA to 100 mA NCP4688xx40**

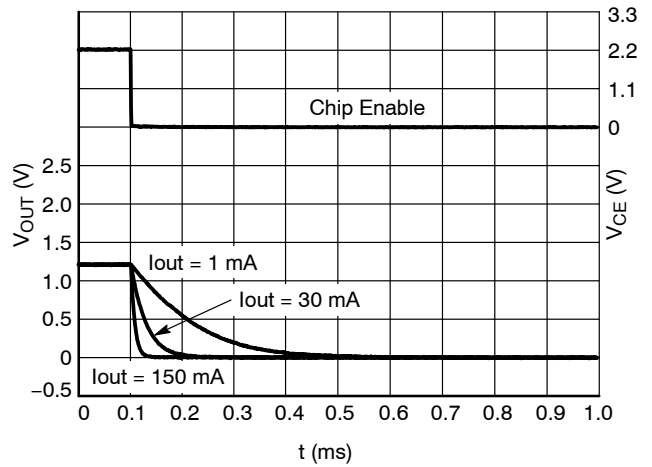

**Figure 36. Turn Off with CE Behavior NCP4688Dx12**

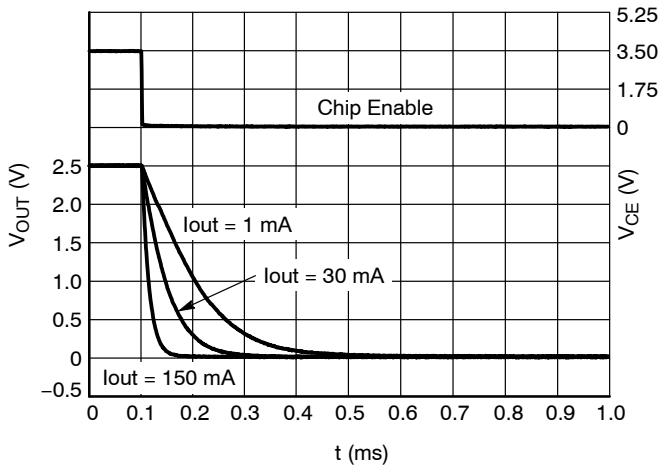

**Figure 37. Turn Off with CE Behavior NCP4688Dx25**

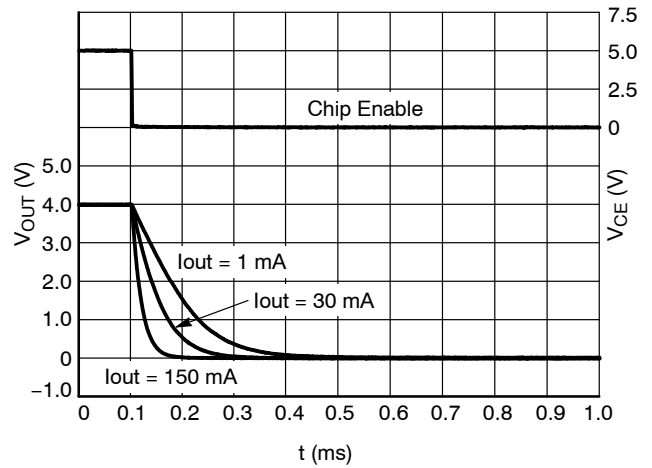

**Figure 38. Turn Off with CE Behavior NCP4688Dx40**

TYPICAL CHARACTERISTICS

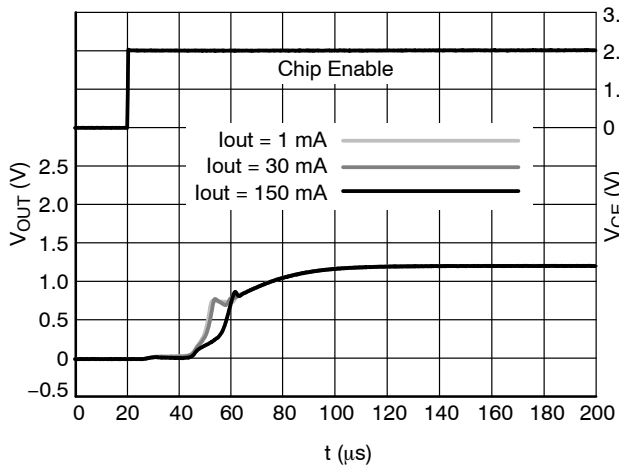

Figure 39. Turn ON with CE Behavior  
NCP4688xx12

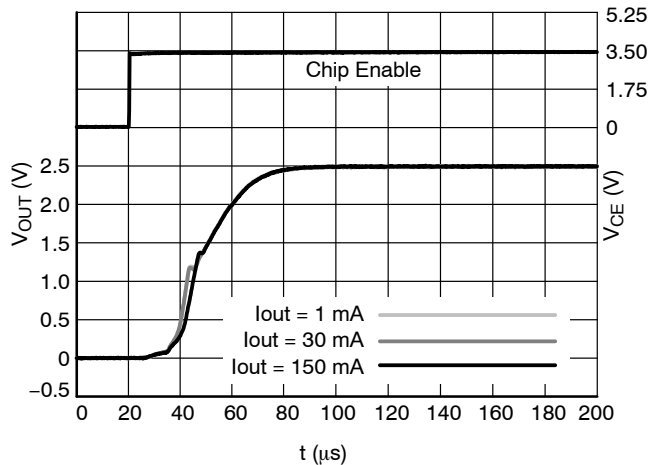

Figure 40. Turn ON with CE Behavior  
NCP4688xx25

APPLICATION INFORMATION

A typical application circuit for NCP4688 series is shown in the Figure 41.

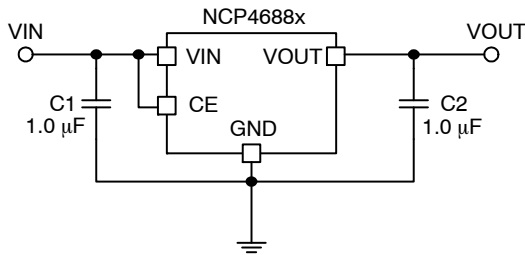

Figure 41. Typical Application Schematic

**Input Decoupling Capacitor (C1)**

A 1.0 μF ceramic input decoupling capacitor should be connected as close as possible to the input and ground pin of the NCP4688 device. Higher values and lower ESR improves line transient response.

**Output Decoupling Capacitor (C2)**

A 1.0 μF ceramic output decoupling capacitor is sufficient to achieve stable operation of the device. If tantalum capacitor is used, and its ESR is high, the loop oscillation may result. For information about ESR see Figures 42, 43 and 44. The capacitor should be connected as close as possible to the output and ground pin. Larger values and lower ESR improves dynamic parameters.

**Enable Operation**

The enable pin CE may be used for turning the regulator on and off. The IC is switched on when a high level voltage is applied to the CE pin. The enable pin has an internal pull down current source which assure off state of LDO in case the CE pin will stay floating. If the enable function is not needed connect CE pin to V<sub>IN</sub>.

The D version of the NCP4688 device includes a transistor between V<sub>OUT</sub> and GND that is used for faster discharging of the output capacitor. This function is activated when the IC goes into disable mode.

**Thermal Consideration**

As a power across the IC increase, it might become necessary to provide some thermal relief. The maximum power dissipation supported by the device is dependent upon board design and layout. Mounting pad configuration on the PCB, the board material, and also the ambient temperature affect the rate of temperature increase for the part. When the device has good thermal conductivity through the PCB the junction temperature will be relatively low in high power dissipation applications.

**ESR vs. Output Current**

When using the NCP4688 devices, consider the following points:

The relation between Output Current I<sub>out</sub> and ESR of the output capacitor are shown below in Figures 42, 43 and 44. The conditions when the device performs stable operation are marked as the hatched area in the charts.

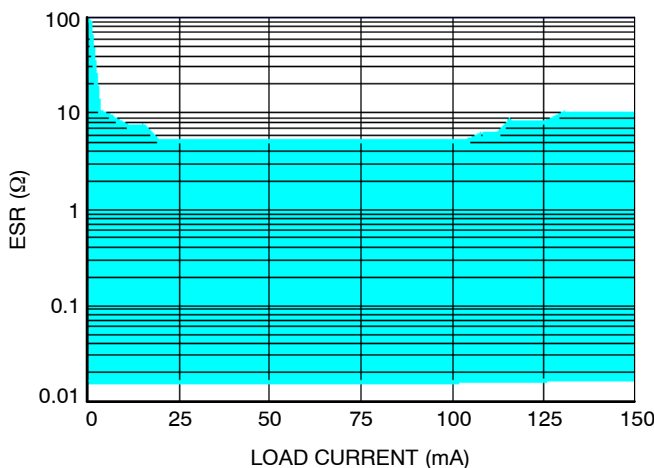

Figure 42. ESR vs. Load Current NCP4688xx12

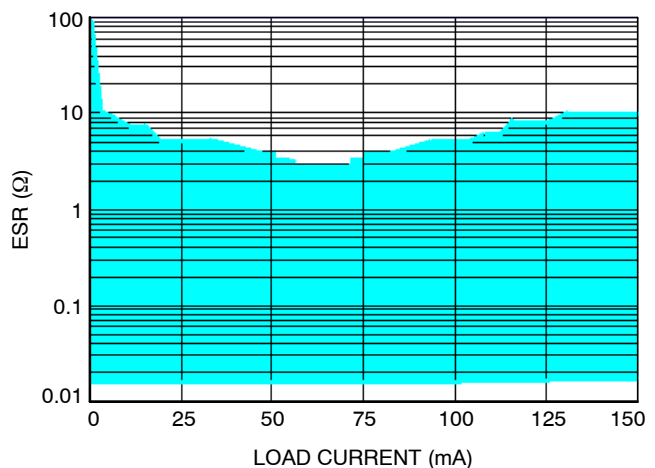
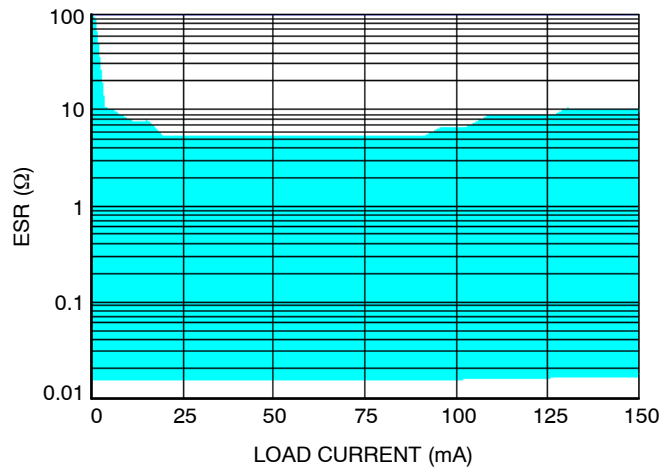

Figure 43. ESR vs. Load Current NCP4688xx25

## NCP4688



**Figure 44. ESR vs. Load Current NCP4688xx40**

### ORDERING INFORMATION

| Device          | Marking | Nominal Output Voltage | Feature        | Package           | Shipping <sup>†</sup> |
|-----------------|---------|------------------------|----------------|-------------------|-----------------------|
| NCP4688DMU12TCG | 3A      | 1.2 V                  | Auto discharge | DFN1010 (Pb-Free) | 10000 / Tape & Reel   |
| NCP4688DMU15TCG | 3E      | 1.5 V                  | Auto discharge | DFN1010 (Pb-Free) | 10000 / Tape & Reel   |
| NCP4688DMU18TCG | 3H      | 1.8 V                  | Auto discharge | DFN1010 (Pb-Free) | 10000 / Tape & Reel   |
| NCP4688DMU25TCG | 3R      | 2.5 V                  | Auto discharge | DFN1010 (Pb-Free) | 10000 / Tape & Reel   |
| NCP4688DMU28TCG | 3U      | 2.8 V                  | Auto discharge | DFN1010 (Pb-Free) | 10000 / Tape & Reel   |
| NCP4688DMU30TCG | 3X      | 3.0 V                  | Auto discharge | DFN1010 (Pb-Free) | 10000 / Tape & Reel   |
| NCP4688DMU33TCG | 4A      | 3.3 V                  | Auto discharge | DFN1010 (Pb-Free) | 10000 / Tape & Reel   |
| NCP4688DSN12T1G | L12     | 1.2 V                  | Auto discharge | SOT-23 (Pb-Free)  | 3000 / Tape & Reel    |
| NCP4688DSN15T1G | L15     | 1.5 V                  | Auto discharge | SOT-23 (Pb-Free)  | 3000 / Tape & Reel    |
| NCP4688DSN18T1G | L18     | 1.8 V                  | Auto discharge | SOT-23 (Pb-Free)  | 3000 / Tape & Reel    |
| NCP4688DSN25T1G | L25     | 2.5 V                  | Auto discharge | SOT-23 (Pb-Free)  | 3000 / Tape & Reel    |
| NCP4688DSN28T1G | L28     | 2.8 V                  | Auto discharge | SOT-23 (Pb-Free)  | 3000 / Tape & Reel    |
| NCP4688DSN33T1G | L33     | 3.3 V                  | Auto discharge | SOT-23 (Pb-Free)  | 3000 / Tape & Reel    |

<sup>†</sup>For information on tape and reel specifications, including part orientation and tape sizes, please refer to our Tape and Reel Packaging Specifications Brochure, BRD8011/D.

# MECHANICAL CASE OUTLINE

## PACKAGE DIMENSIONS

ON Semiconductor®



SCALE 2:1

### SOT-23 5-LEAD CASE 1212-01 ISSUE A

DATE 28 JAN 2011

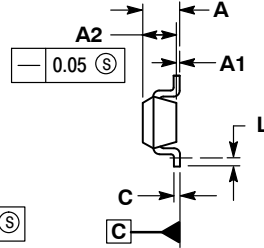
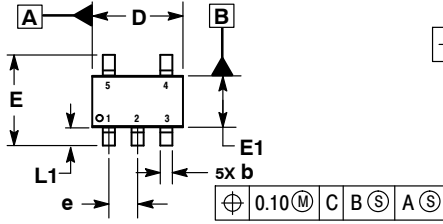

NOTES:

1. DIMENSIONING AND TOLERANCING PER ASME Y14.5M, 1994.
2. CONTROLLING DIMENSIONS: MILLIMETERS.
3. DATUM C IS THE SEATING PLANE.

| MILLIMETERS |          |      |
|-------------|----------|------|
| DIM         | MIN      | MAX  |
| A           | ---      | 1.45 |
| A1          | 0.00     | 0.10 |
| A2          | 1.00     | 1.30 |
| b           | 0.30     | 0.50 |
| c           | 0.10     | 0.25 |
| D           | 2.70     | 3.10 |
| E           | 2.50     | 3.10 |
| E1          | 1.50     | 1.80 |
| e           | 0.95 BSC | ---  |
| L           | 0.20     | ---  |
| L1          | 0.45     | 0.75 |

### RECOMMENDED SOLDERING FOOTPRINT\*

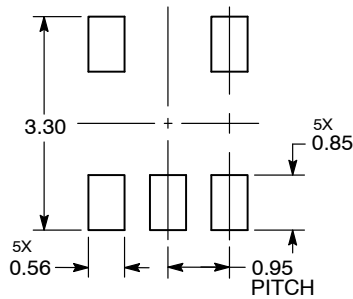

DIMENSIONS: MILLIMETERS

\*For additional information on our Pb-Free strategy and soldering details, please download the ON Semiconductor Soldering and Mounting Techniques Reference Manual, SOLDERRM/D.

### GENERIC MARKING DIAGRAM\*

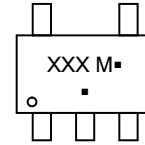

XXX = Specific Device Code

M = Date Code

▪ = Pb-Free Package

(Note: Microdot may be in either location)

\*This information is generic. Please refer to device data sheet for actual part marking. Pb-Free indicator, "G" or microdot "▪", may or may not be present.

|                  |               |  |
|------------------|---------------|--|
| DOCUMENT NUMBER: | 98ASH70518A   | Electronic versions are uncontrolled except when accessed directly from the Document Repository. Printed versions are uncontrolled except when stamped "CONTROLLED COPY" in red. |
| DESCRIPTION:     | SOT-23 5-LEAD | PAGE 1 OF 1  |

ON Semiconductor and are trademarks of Semiconductor Components Industries, LLC dba ON Semiconductor or its subsidiaries in the United States and/or other countries. ON Semiconductor reserves the right to make changes without further notice to any products herein. ON Semiconductor makes no warranty, representation or guarantee regarding the suitability of its products for any particular purpose, nor does ON Semiconductor assume any liability arising out of the application or use of any product or circuit, and specifically disclaims any and all liability, including without limitation special, consequential or incidental damages. ON Semiconductor does not convey any license under its patent rights nor the rights of others.

# MECHANICAL CASE OUTLINE

## PACKAGE DIMENSIONS

ON Semiconductor®



SCALE 4:1

UDFN4 1.0x1.0, 0.65P  
CASE 517BR-01  
ISSUE O

DATE 27 OCT 2010

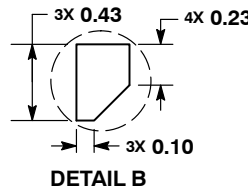
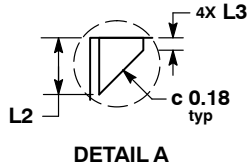
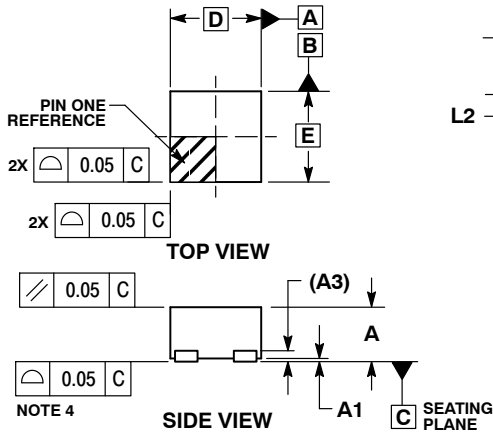

- NOTES:
1. DIMENSIONING AND TOLERANCING PER ASME Y14.5M, 1994.
  2. CONTROLLING DIMENSION: MILLIMETERS.
  3. DIMENSION b APPLIES TO PLATED TERMINAL AND IS MEASURED BETWEEN 0.15 AND 0.20 mm FROM TERMINAL.
  4. COPLANARITY APPLIES TO THE EXPOSED PAD AS WELL AS THE TERMINALS.

| MILLIMETERS |      |      |
|-------------|------|------|
| DIM         | MIN  | MAX  |
| A           | ---  | 0.60 |
| A1          | 0.00 | 0.05 |
| A3          | 0.10 | REF  |
| b           | 0.20 | 0.30 |
| D           | 1.00 | BSC  |
| D2          | 0.43 | 0.53 |
| E           | 1.00 | BSC  |
| e           | 0.65 | BSC  |
| L           | 0.20 | 0.30 |
| L2          | 0.27 | 0.37 |
| L3          | 0.02 | 0.12 |

### GENERIC MARKING DIAGRAM\*

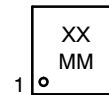

XX = Specific Device Code  
MM = Date Code

\*This information is generic. Please refer to device data sheet for actual part marking.  
Pb-Free indicator, "G" or microdot "▪", may or may not be present.

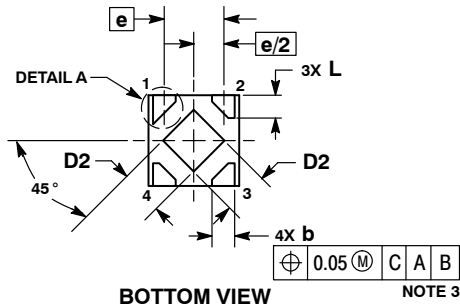

### RECOMMENDED MOUNTING FOOTPRINT\*

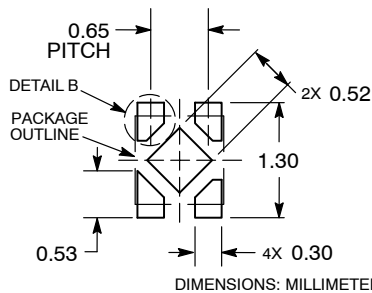

\*For additional information on our Pb-Free strategy and soldering details, please download the ON Semiconductor Soldering and Mounting Techniques Reference Manual, SOLDERRM/D.

|                         |                              |  |
|-------------------------|------------------------------|--|
| <b>DOCUMENT NUMBER:</b> | <b>98AON53254E</b>           | Electronic versions are uncontrolled except when accessed directly from the Document Repository. Printed versions are uncontrolled except when stamped "CONTROLLED COPY" in red. |
| <b>DESCRIPTION:</b>     | <b>UDFN4, 1.0X1.0, 0.65P</b> | <b>PAGE 1 OF 1</b>   |

ON Semiconductor and ON are trademarks of Semiconductor Components Industries, LLC dba ON Semiconductor or its subsidiaries in the United States and/or other countries. ON Semiconductor reserves the right to make changes without further notice to any products herein. ON Semiconductor makes no warranty, representation or guarantee regarding the suitability of its products for any particular purpose, nor does ON Semiconductor assume any liability arising out of the application or use of any product or circuit, and specifically disclaims any and all liability, including without limitation special, consequential or incidental damages. ON Semiconductor does not convey any license under its patent rights nor the rights of others.

ON Semiconductor and  are trademarks of Semiconductor Components Industries, LLC dba ON Semiconductor or its subsidiaries in the United States and/or other countries. ON Semiconductor owns the rights to a number of patents, trademarks, copyrights, trade secrets, and other intellectual property. A listing of ON Semiconductor's product/patent coverage may be accessed at [www.onsemi.com/site/pdf/Patent-Marking.pdf](http://www.onsemi.com/site/pdf/Patent-Marking.pdf). ON Semiconductor reserves the right to make changes without further notice to any products herein. ON Semiconductor makes no warranty, representation or guarantee regarding the suitability of its products for any particular purpose, nor does ON Semiconductor assume any liability arising out of the application or use of any product or circuit, and specifically disclaims any and all liability, including without limitation special, consequential or incidental damages. Buyer is responsible for its products and applications using ON Semiconductor products, including compliance with all laws, regulations and safety requirements or standards, regardless of any support or applications information provided by ON Semiconductor. "Typical" parameters which may be provided in ON Semiconductor data sheets and/or specifications can and do vary in different applications and actual performance may vary over time. All operating parameters, including "Typicals" must be validated for each customer application by customer's technical experts. ON Semiconductor does not convey any license under its patent rights nor the rights of others. ON Semiconductor products are not designed, intended, or authorized for use as a critical component in life support systems or any FDA Class 3 medical devices or medical devices with a same or similar classification in a foreign jurisdiction or any devices intended for implantation in the human body. Should Buyer purchase or use ON Semiconductor products for any such unintended or unauthorized application, Buyer shall indemnify and hold ON Semiconductor and its officers, employees, subsidiaries, affiliates, and distributors harmless against all claims, costs, damages, and expenses, and reasonable attorney fees arising out of, directly or indirectly, any claim of personal injury or death associated with such unintended or unauthorized use, even if such claim alleges that ON Semiconductor was negligent regarding the design or manufacture of the part. ON Semiconductor is an Equal Opportunity/Affirmative Action Employer. This literature is subject to all applicable copyright laws and is not for resale in any manner.

## PUBLICATION ORDERING INFORMATION

### LITERATURE FULFILLMENT:

Email Requests to: [orderlit@onsemi.com](mailto:orderlit@onsemi.com)

ON Semiconductor Website: [www.onsemi.com](http://www.onsemi.com)

### TECHNICAL SUPPORT

North American Technical Support:  
Voice Mail: 1 800-282-9855 Toll Free USA/Canada  
Phone: 011 421 33 790 2910

### Europe, Middle East and Africa Technical Support:

Phone: 00421 33 790 2910

For additional information, please contact your local Sales Representative

## X-ON Electronics

Largest Supplier of Electrical and Electronic Components

*Click to view similar products for [LDO Voltage Regulators](#) category:*

*Click to view products by [ON Semiconductor](#) manufacturer:*

Other Similar products are found below :

[M38D29FFHP#U1](#) [702103A](#) [717726C](#) [742457H](#) [MP20051DN-LF-Z](#) [R5F111PGGFB#30](#) [AP7363-SP-13](#) [NCP103AMX285TCG](#)  
[NCV8664CST33T3G](#) [NCV8752AMX28TCG](#) [L9454](#) [AP7362-HA-7](#) [LX13043CLD](#) [TCR3DF185,LM\(CT](#) [TCR3DF24,LM\(CT](#)  
[TCR3DF285,LM\(CT](#) [TCR3DF31,LM\(CT](#) [TCR3DF45,LM\(CT](#) [TLF4949EJ](#) [MP2013GQ-33-Z](#) [L9708](#) [L970813TR](#) [030014BB](#) [059985X](#)  
[NCP121AMX173TCG](#) [NCP4687DH15T1G](#) [701326R](#) [702087BB](#) [755078E](#) [TCR2EN28,LF\(S](#) [LM1117DT-1.8/NO](#) [LT1086CM#TRPBF](#)  
[AZ1085S2-1.5TRE1](#) [MAX15101EWL+T](#) [NCV8170AXV250T2G](#) [TCR3DF27,LM\(CT](#) [TCR3DF19,LM\(CT](#) [TCR3DF125,LM\(CT](#)  
[TCR2EN18,LF\(S](#) [MAX15103EWL+T](#) [TS2937CZ-5.0 C0](#) [MAX8878EUK30-T](#) [MAX663CPA](#) [NCV4269CPD50R2G](#) [NCV8716MT30TBG](#)  
[AZ1117IH-1.2TRG1](#) [MP2013GQ-P](#) [AP2112R5A-3.3TRG1](#) [AP7315-25W5-7](#) [MAX15102EWL+T](#)