

# NCP5106BA36WGEVB

## NCP5106B 36W Ballast Evaluation Board User's Manual



ON Semiconductor®

<http://onsemi.com>

### EVAL BOARD USER'S MANUAL

#### Introduction

This document describes how the NCP5106B driver can be implemented in a ballast application. The scope of this application note is to highlight the NCP5106B driver and not to explain or detailed how to build electronic ballast.

The NCP5106B is a high voltage power MOSFET driver providing two outputs for direct drive of 2 N-channel power MOSFETs arranged in a half-bridge configuration with a cross conduction protection between the 2 channels.

It uses the bootstrap technique to insure a proper drive of the High-side power switch. The driver works with 2 independent inputs to accommodate any topology (including half-bridge, asymmetrical half-bridge, active clamp and full-bridge).

#### Evaluation Board Specification

- Input range : 85 – 145 Vac or 184 – 265 Vac
- Ballast Output power : 36 W (type PL-L 36W)
  - ◆ Pre-Heating current : 295 mA
  - ◆ Pre-heating time : 1 second
  - ◆ Nominal current : 414 mA

**BEFORE PLUGGING IN THE DEMO BOARD, MAKE SURE THE JUMPER IS ON THE CORRECT POSITION: IF J2 IS USED, THEN  $V_{in}$  MUST BE LOWER THAN 145 Vac.**

#### Detailed Operation

The lamp ballast is powered via a half bridge configuration. The 2 power MOSFETs are driven with the NCP5106B driver. The driver is supplied by the VCC rail, and the high side driver is supplied by the bootstrap diode: when the low side power MOSFET (Q2) is switched ON, the BRIDGE pin is pulled down to the ground, thus the capacitor connected between BRIDGE pin and VBOOT pin is refuelled via the diode D3 and the resistor R5 connected to VCC. When Q2 is switched OFF the bootstrap capacitor C6 supplies the high side driver with a voltage equal to VCC level minus the D3 forward voltage diode. Given the NCP5106B architecture, it is up to the designer to generate the right input signal polarity with the desired dead time. Nevertheless the NCP5106B provides a cross conduction protection with an internal fixed dead time. Thus in case of overlap on the inputs signal, the both outputs driver will be kept in low state, or a minimum of 100 ns dead time will be applied between the both drivers.

The 555 timer generates only one signal for the driver, the second one, in opposite phase is built by inserting a NPN transistor (Q4) for inverting the signal. Afterwards the dead time is built with R2, D2 and C13 (typically 400 ns, see Figure 2).



Figure 1. Evaluation Board Photo

# NCP5106BA36WGEVB

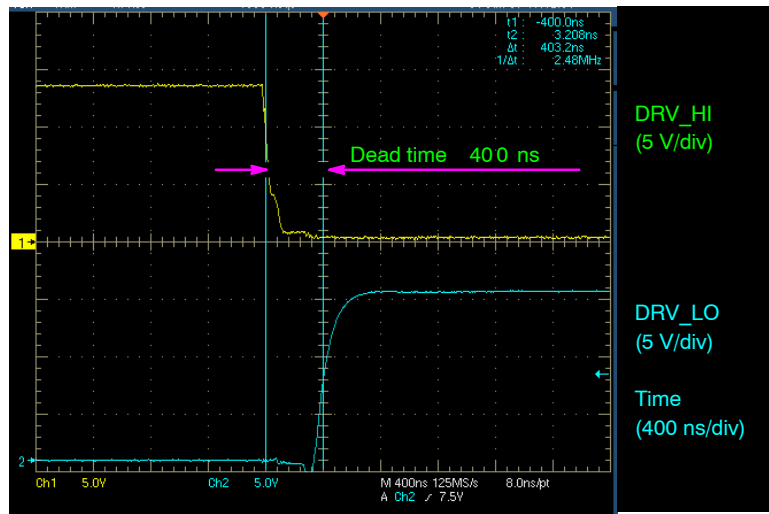

Figure 2. Dead Time Between the High and Low Side Driver

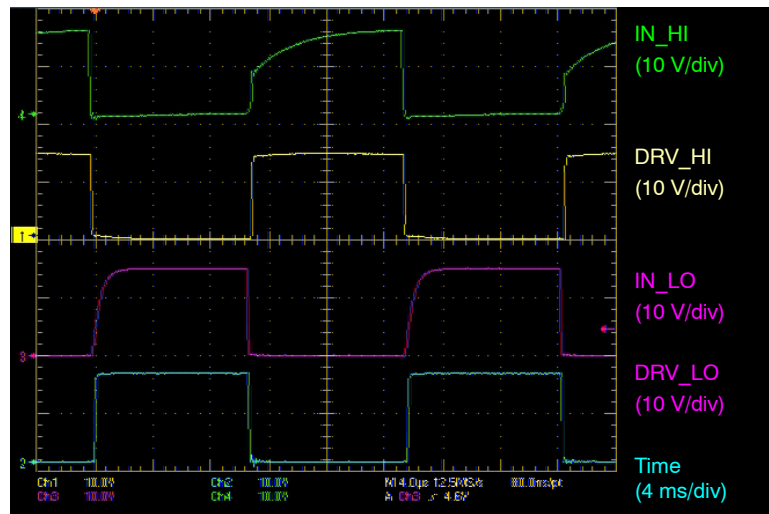

Figure 3. Input Output Timing Diagram

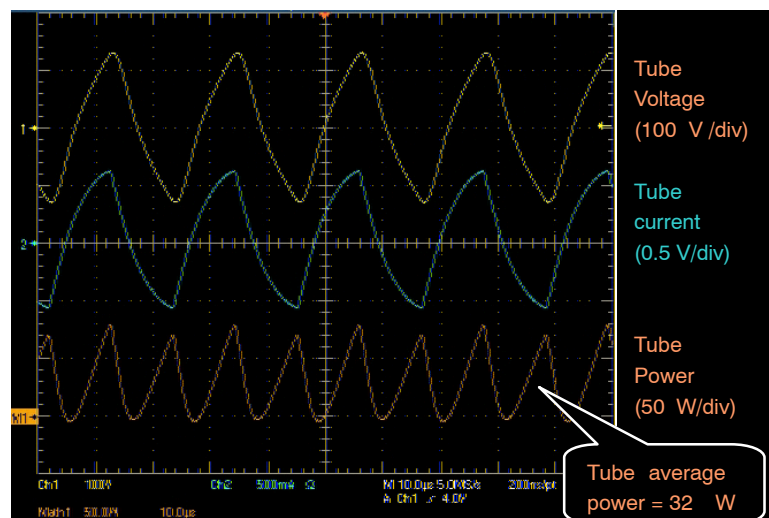

Figure 4. Tube Signals

# NCP5106BA36WGEVB

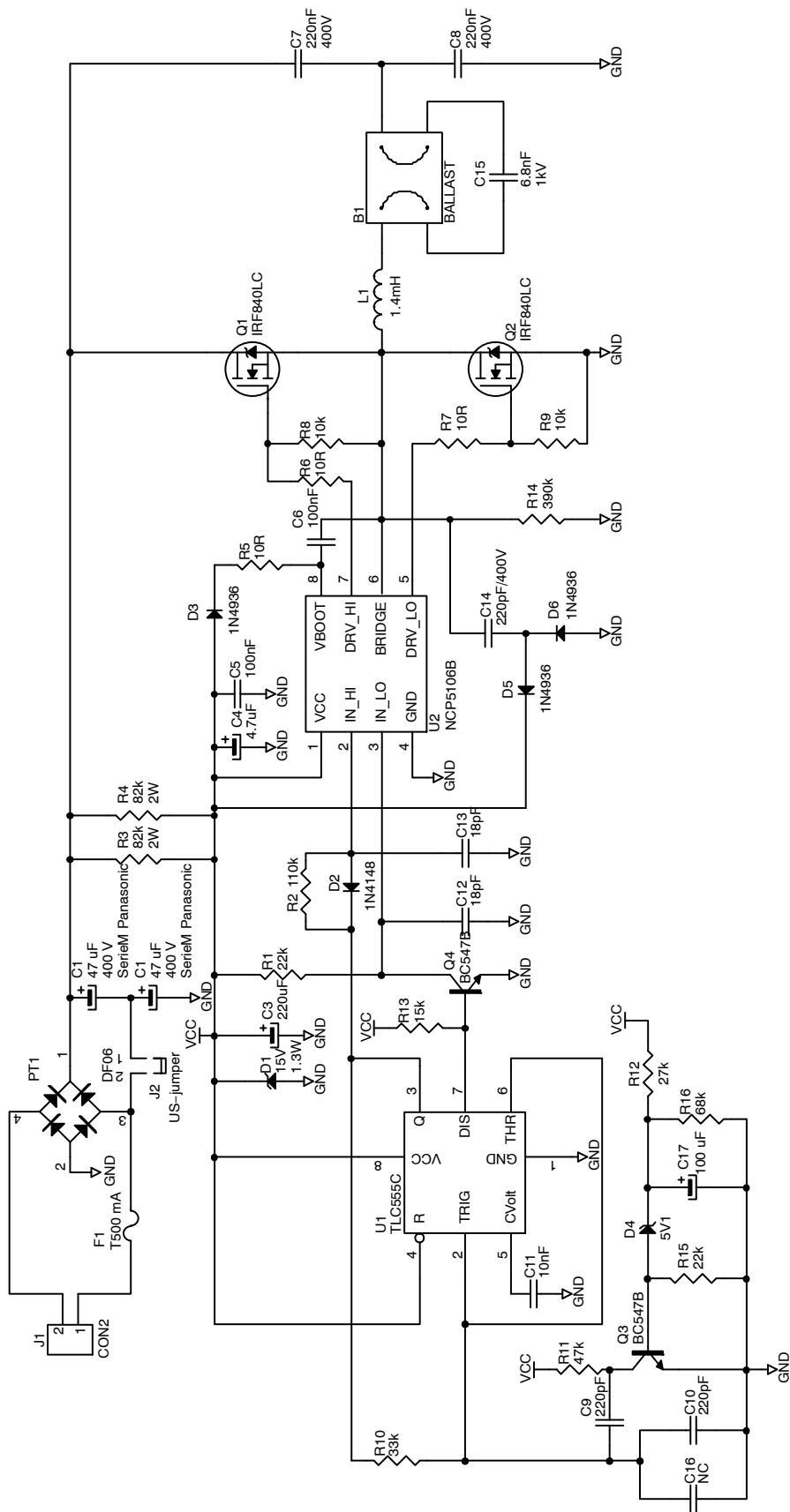

Figure 5. Evaluation Board Schematic

# NCP5106A36WGEVB

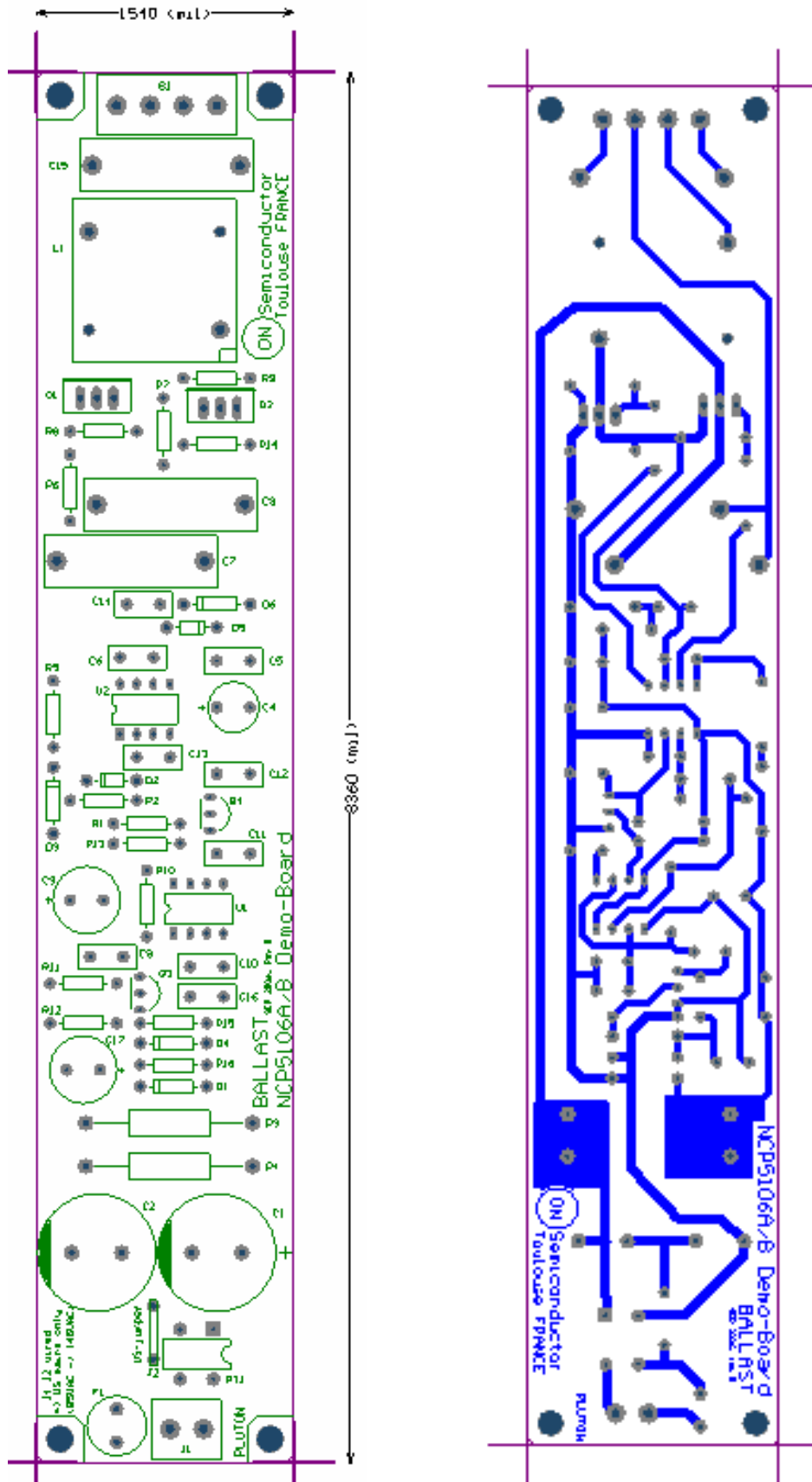

Figure 6. PCB Printout: Top and Bottom View

# NCP5106BA36WGEVB

## BILL OF MATERIALS

Designator	Qty	Description	Value	Tolerance	Footprint	Manufacturer	Manufacturer Part Number	Substitution Allowed	Lead Free
B1	2	Connector	2"	-	rad5.08mm	Weidmuller	PM5.08/2/90	Yes	Yes
C1, C2	2	Electrolytic Capacitor	47 uF, 400 V	20%	radial	Panasonic	ECA2GM470	Yes	Yes
C11	1	Capacitor	10 nF, 100 V	10%	radial	Murata	RPER72A103K2M1B05A	Yes	Yes
C12, C13	2	Capacitor	18 pF, 100 V	2%	radial	BC Comp.	2222-682-10189	Yes	Yes
C14	1	Capacitor	220 pF, 1000 V	10%	radial	Panasonic	PICECKA3A221KBP	Yes	Yes
C15	1	Capacitor	6.8 nF, 1600 V	5%	radial	BC Comp.	2222 375 30682	Yes	Yes
C16	1	Capacitor	-	-	radial	-	-	Yes	Yes
C17	1	Electrolytic Capacitor	100 uF, 16 V	20%	radial	Panasonic	ECA1CM101	Yes	Yes
C3	1	Electrolytic Capacitor	220 uF, 16 V	20%	radial	BC Comp.	2222-13555221	Yes	Yes
C4	1	Electrolytic Capacitor	4.7 uF, 63 V	20%	radial	Nippon Chemi-Con	SMEVB4.7UF63V	Yes	Yes
C5, C6	2	Capacitor	100 nF, 50 V	10%	radial	Murata	RPER71H104K2M1A05U	Yes	Yes
C7, C8	2	Capacitor	220 nF, 400 V	10%	radial	Vishay	MKT1822422405	Yes	Yes
C9, C10	2	Capacitor	220 pF, 100 V	5%	radial	Murata	RPE5C2A221J2M1Z05A	Yes	Yes
D1	1	Zener Diode	15 V, 1.3 W	5%	axial	Vishay	BZX85C15	Yes	Yes
D2	1	High-Speed Diode	0.2 A, 75 V	0%	axial	Philips Semiconductor	1N4148	Yes	Yes
D3, D5, D6	3	Rectifier Diode	1 A, 400 V	0%	axial	ON Semiconductor	1N4936G	Yes	Yes
D4	1	Zener Diode	5.1 V, 1.3 W	5%	axial	Vishay	BZX85C5V1	Yes	Yes
F1	1	Fuse	500 mA, 250 V	0%	radial	Schurter	0034-6612	Yes	Yes
J1	1	Connector	2"	-	rad5.08mm	Weidmuller	PM5.08/2/90	Yes	Yes
J2	1	Resistor	0 Ω, 0.25 W	0%	axial	Multicomp	MCF0.25W0R	Yes	Yes
L1	1	Inductor	1.4 mH	-	-	Vogt	53-044	No	Yes
PT1	1	Diode Bridge	600 V, 1 A	0%	dil	General Semiconductor	DF06M	Yes	Yes
Q1, Q2	2	Power MOSFET N-Channel	8 A, 500 V	-	to220	International Rectifier	INF840LC	Yes	Yes
Q3, Q4	2	NPN Transistor	100 mA, 45 V	-	to92	ON Semiconductor	BC547B	Yes	Yes
R1, R15	1	Resistor	22 kΩ, 0.33 W	5%	axial	Neohm	CFR25J22K	Yes	Yes
R10	1	Resistor	33 kΩ, 0.33 W	5%	axial	Neohm	CFR25J33K	Yes	Yes
R11	1	Resistor	47 kΩ, 0.33 W	5%	axial	Neohm	CFR25J45K	Yes	Yes
R12	1	Resistor	27 kΩ, 0.33 W	5%	axial	Neohm	CFR25J27K	Yes	Yes
R13	1	Resistor	15 kΩ, 0.33 W	5%	axial	Neohm	CFR25J15K	Yes	Yes
R14	1	Resistor	390 kΩ, 0.33 W	5%	axial	Neohm	CFR25J390K	Yes	Yes
R16	1	Resistor	68 kΩ, 0.33 W	5%	axial	Neohm	CFR25J68K	Yes	Yes
R2	1	Resistor	120 kΩ, 0.33 W	5%	axial	Neohm	CFR25J120K	Yes	Yes
R3, R4	2	Resistor	82 kΩ, 3 W	5%	axial	BC Comp.	232219514823	Yes	Yes
R5, R6, R7	3	Resistor	10 Ω, 0.33 W	5%	axial	Neohm	CFR25J10R	Yes	Yes
R8, R9	2	Resistor	10 kΩ, 0.33 W	5%	axial	Neohm	CFR25J10K	Yes	Yes
U1	1	CMOS IC	analog/timer	-	dip8	Texas Instruments	TLC555CP	No	Yes
U2	1	NCP5106B	NCP5106B	-	dip8	ON Semiconductor	NCP5106B	No	Yes

# NCP5106BA36WGEVB

## TEST PROCEDURE FOR THE NCP5106B EVALUATION BOARD

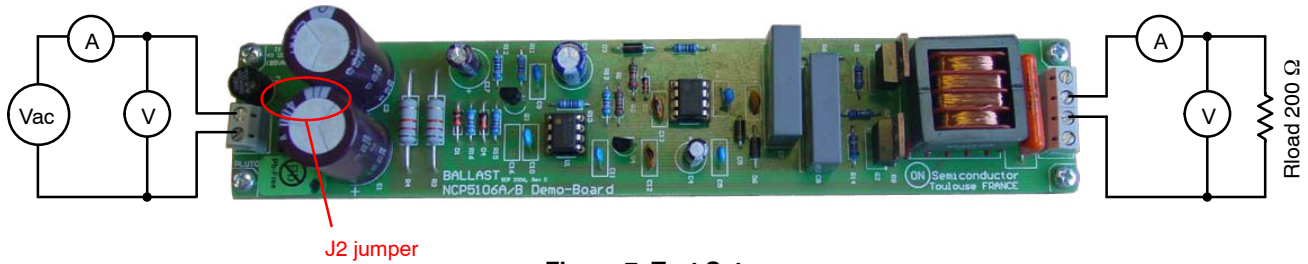

Figure 7. Test Setup

### Required Equipment

- AC power source can be able to deliver 230 Vrms or 110 Vrms
- Two volt–meters
- Two ampere–meters
- 1 resistive load: 200  $\Omega$  / 50 W
- One NCP5106B Evaluation Board

### Test Procedure

1. First of all check if you need or not the jumper #2 (J2 on the board close the diode bridge). This jumper must be removed in case of European mains (230 Vac input voltage) and have to placed in case of US mains (110 Vac). This jumper is used

- to build a voltage doublers just after the bridge diode in case of US mains input voltage range.
2. Connect the test setup as shown above:
  - AC source
  - Voltmeter and Ampere meter on the load
  - Load on the output
3. Apply 230 Vac if European mains or 110 Vac for the US mains on the input connector.
4. Compare  $I_{load}$  and  $V_{load}$  with the following table according your input mains voltage.
5. If you get the correct output and input voltage, you can now connect a 36 W fluorescent tube on the output (see the ballast connection figure).

### TEST RESULTS:

Input Mains	J2	Vin (Vrms)	Iin (Arms)	Vload (Vrms)	Iload (Arms)
European	Removed	230 V	278 mA	303 V	370 mA
US	Yes $\rightarrow$ max input voltage: 132 Vrms	100 V	514 mA	263 V	340 mA

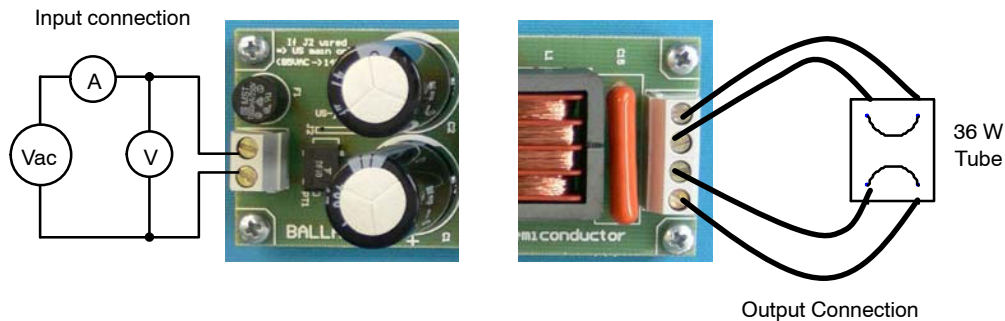

Figure 8. Ballast Connection

**onsemi**, **Onsemi**, and other names, marks, and brands are registered and/or common law trademarks of Semiconductor Components Industries, LLC dba "**onsemi**" or its affiliates and/or subsidiaries in the United States and/or other countries. **onsemi** owns the rights to a number of patents, trademarks, copyrights, trade secrets, and other intellectual property. A listing of **onsemi**'s product/patent coverage may be accessed at [www.onsemi.com/site/pdf/Patent-Marking.pdf](http://www.onsemi.com/site/pdf/Patent-Marking.pdf). **onsemi** is an Equal Opportunity/Affirmative Action Employer. This literature is subject to all applicable copyright laws and is not for resale in any manner.

The evaluation board/kit (research and development board/kit) (hereinafter the "board") is not a finished product and is not available for sale to consumers. The board is only intended for research, development, demonstration and evaluation purposes and will only be used in laboratory/development areas by persons with an engineering/technical training and familiar with the risks associated with handling electrical/mechanical components, systems and subsystems. This person assumes full responsibility/liability for proper and safe handling. Any other use, resale or redistribution for any other purpose is strictly prohibited.

**THE BOARD IS PROVIDED BY ONSEMI TO YOU "AS IS" AND WITHOUT ANY REPRESENTATIONS OR WARRANTIES WHATSOEVER. WITHOUT LIMITING THE FOREGOING, ONSEMI (AND ITS LICENSORS/SUPPLIERS) HEREBY DISCLAIMS ANY AND ALL REPRESENTATIONS AND WARRANTIES IN RELATION TO THE BOARD, ANY MODIFICATIONS, OR THIS AGREEMENT, WHETHER EXPRESS, IMPLIED, STATUTORY OR OTHERWISE, INCLUDING WITHOUT LIMITATION ANY AND ALL REPRESENTATIONS AND WARRANTIES OF MERCHANTABILITY, FITNESS FOR A PARTICULAR PURPOSE, TITLE, NON-INFRINGEMENT, AND THOSE ARISING FROM A COURSE OF DEALING, TRADE USAGE, TRADE CUSTOM OR TRADE PRACTICE.**

**onsemi** reserves the right to make changes without further notice to any board.

You are responsible for determining whether the board will be suitable for your intended use or application or will achieve your intended results. Prior to using or distributing any systems that have been evaluated, designed or tested using the board, you agree to test and validate your design to confirm the functionality for your application. Any technical, applications or design information or advice, quality characterization, reliability data or other services provided by **onsemi** shall not constitute any representation or warranty by **onsemi**, and no additional obligations or liabilities shall arise from **onsemi** having provided such information or services.

**onsemi** products including the boards are not designed, intended, or authorized for use in life support systems, or any FDA Class 3 medical devices or medical devices with a similar or equivalent classification in a foreign jurisdiction, or any devices intended for implantation in the human body. You agree to indemnify, defend and hold harmless **onsemi**, its directors, officers, employees, representatives, agents, subsidiaries, affiliates, distributors, and assigns, against any and all liabilities, losses, costs, damages, judgments, and expenses, arising out of any claim, demand, investigation, lawsuit, regulatory action or cause of action arising out of or associated with any unauthorized use, even if such claim alleges that **onsemi** was negligent regarding the design or manufacture of any products and/or the board.

This evaluation board/kit does not fall within the scope of the European Union directives regarding electromagnetic compatibility, restricted substances (RoHS), recycling (WEEE), FCC, CE or UL, and may not meet the technical requirements of these or other related directives.

FCC WARNING – This evaluation board/kit is intended for use for engineering development, demonstration, or evaluation purposes only and is not considered by **onsemi** to be a finished end product fit for general consumer use. It may generate, use, or radiate radio frequency energy and has not been tested for compliance with the limits of computing devices pursuant to part 15 of FCC rules, which are designed to provide reasonable protection against radio frequency interference. Operation of this equipment may cause interference with radio communications, in which case the user shall be responsible, at its expense, to take whatever measures may be required to correct this interference.

**onsemi** does not convey any license under its patent rights nor the rights of others.

LIMITATIONS OF LIABILITY: **onsemi** shall not be liable for any special, consequential, incidental, indirect or punitive damages, including, but not limited to the costs of requalification, delay, loss of profits or goodwill, arising out of or in connection with the board, even if **onsemi** is advised of the possibility of such damages. In no event shall **onsemi**'s aggregate liability from any obligation arising out of or in connection with the board, under any theory of liability, exceed the purchase price paid for the board, if any.

The board is provided to you subject to the license and other terms per **onsemi**'s standard terms and conditions of sale. For more information and documentation, please visit [www.onsemi.com](http://www.onsemi.com).

## PUBLICATION ORDERING INFORMATION

### LITERATURE FULFILLMENT:

Email Requests to: [orderlit@onsemi.com](mailto:orderlit@onsemi.com)

**onsemi Website:** [www.onsemi.com](http://www.onsemi.com)

### TECHNICAL SUPPORT

**North American Technical Support:**

Voice Mail: 1 800-282-9855 Toll Free USA/Canada

Phone: 011 421 33 790 2910

**Europe, Middle East and Africa Technical Support:**

Phone: 00421 33 790 2910

For additional information, please contact your local Sales Representative

## X-ON Electronics

Largest Supplier of Electrical and Electronic Components

*Click to view similar products for* [Power Management IC Development Tools](#) *category:*

*Click to view products by* [ON Semiconductor](#) *manufacturer:*

Other Similar products are found below :

[EVAL-ADM1168LQEBZ](#) [EVB-EP5348UI](#) [MIC23451-AAAYFL EV](#) [MIC5281YMME EV](#) [DA9063-EVAL](#) [ADP122-3.3-EVALZ](#) [ADP130-0.8-EVALZ](#) [ADP130-1.2-EVALZ](#) [ADP130-1.5-EVALZ](#) [ADP130-1.8-EVALZ](#) [ADP1712-3.3-EVALZ](#) [ADP1714-3.3-EVALZ](#) [ADP1715-3.3-EVALZ](#) [ADP1716-2.5-EVALZ](#) [ADP1740-1.5-EVALZ](#) [ADP1752-1.5-EVALZ](#) [ADP1828LC-EVALZ](#) [ADP1870-0.3-EVALZ](#) [ADP1871-0.6-EVALZ](#) [ADP1873-0.6-EVALZ](#) [ADP1874-0.3-EVALZ](#) [ADP1882-1.0-EVALZ](#) [ADP199CB-EVALZ](#) [ADP2102-1.25-EVALZ](#) [ADP2102-1.875EVALZ](#) [ADP2102-1.8-EVALZ](#) [ADP2102-2-EVALZ](#) [ADP2102-3-EVALZ](#) [ADP2102-4-EVALZ](#) [ADP2106-1.8-EVALZ](#) [ADP2147CB-110EVALZ](#) [AS3606-DB](#) [BQ24010EVM](#) [BQ24075TEVM](#) [BQ24155EVM](#) [BQ24157EVM-697](#) [BQ24160EVM-742](#) [BQ24296MEVM-655](#) [BQ25010EVM](#) [BQ3055EVM](#) [NCV891330PD50GEVB](#) [ISLUSBI2CKIT1Z](#) [LM2744EVAL](#) [LM2854EVAL](#) [LM3658SD-AEV/NOPB](#) [LM3658SDEV/NOPB](#) [LM3691TL-1.8EV/NOPB](#) [LM4510SDEV/NOPB](#) [LM5033SD-EVAL](#) [LP38512TS-1.8EV](#)