

NCP566

Linear Regulator - Low Dropout

1.5 A

The NCP566 low dropout linear regulator will provide 1.5 A at a fixed output voltage. The fast loop response and low dropout voltage make this regulator ideal for applications where low voltage and good load transient response are important. Device protection includes current limit, short circuit protection, and thermal shutdown.

Features

- Ultra Fast Transient Response ($< 1.0 \mu\text{s}$)
- Low Ground Current (1.5 mA @ $I_{\text{out}} = 1.5 \text{ A}$)
- Low Dropout Voltage (0.9 V @ $I_{\text{out}} = 1.5 \text{ A}$)
- Low Noise (37 μV_{rms})
- 1.2 V, 1.8 V, 2.5 V Fixed Output Versions.
Other Fixed Voltages Available on Request
- Current Limit Protection
- Thermal Shutdown Protection
- These are Pb-Free Devices

Typical Applications

- Servers
- ASIC Power Supplies
- Post Regulation for Power Supplies
- Constant Current Source
- DTV
- LCD Monitors
- Networking Equipment
- Battery Powered Systems
- Motherboards
- Peripheral Cards
- Set Top Boxes
- Medical Equipment
- Notebook Computers



ON Semiconductor®

<http://onsemi.com>

MARKING DIAGRAMS



SOT-223
CASE 318E

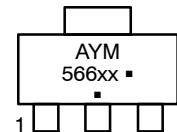

xx = Voltage Rating
12 = 1.2 V
18 = 1.8 V
25 = 2.5 V
A = Assembly Location
Y = Year
M = Date Code
▪ = Pb-Free Package

(Note: Microdot may be in either location)

PIN CONNECTIONS

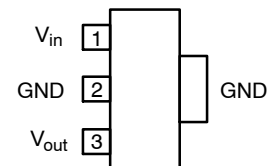

ORDERING INFORMATION

See detailed ordering and shipping information in the package dimensions section on page 9 of this data sheet.

NCP566

PIN DESCRIPTION

Pin No.	Symbol	Description
1	V_{in}	Positive Power Supply Input Voltage
2, Tab	Ground	Power Supply Ground
3	V_{out}	Regulated Output Voltage

MAXIMUM RATINGS

Rating	Symbol	Value	Unit
Input Voltage (Note 1)	V_{in}	9.0	V
Output Pin Voltage	V_{out}	-0.3 to $V_{in} + 0.3$	V
Thermal Characteristics (Notes 2, 3) Thermal Resistance, Junction-to-Ambient Thermal Resistance, Junction-to-Pin	$R_{\theta JA}$ $R_{\theta JP}$	107 12	$^{\circ}C/W$
Operating Junction Temperature Range	T_J	-40 to 150	$^{\circ}C$
Operating Ambient Temperature Range	T_A	-40 to 125	$^{\circ}C$
Storage Temperature Range	T_{stg}	-55 to 150	$^{\circ}C$

Stresses exceeding Maximum Ratings may damage the device. Maximum Ratings are stress ratings only. Functional operation above the Recommended Operating Conditions is not implied. Extended exposure to stresses above the Recommended Operating Conditions may affect device reliability.

- This device series contains ESD protection and exceeds the following tests:
Human Body Model JESD 22-A114-B
Machine Model JESD 22-A115-A

- The maximum package power dissipation is:

$$P_D = \frac{T_{J(max)} - T_A}{R_{\theta JA}}$$

- As measured using a copper heat spreading area of 50 mm², 1 oz copper thickness.

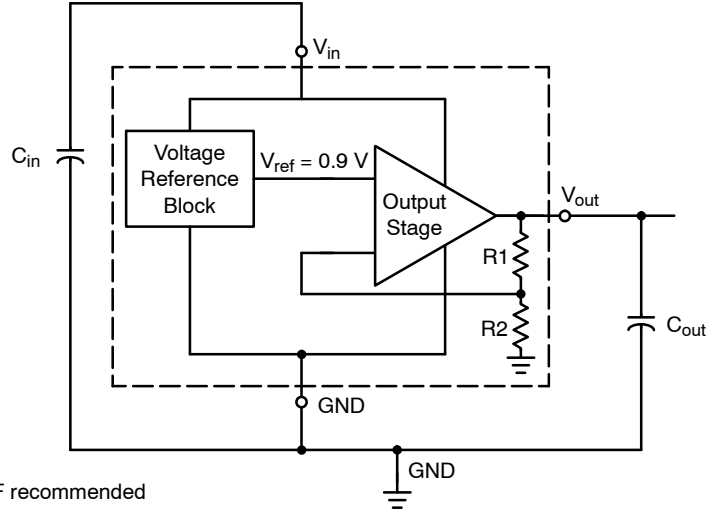

C_{in} - 4.7 μF to 150 μF recommended

C_{out} - 2.2 μF to 150 μF recommended

See more details in Applications Information section

Figure 1. Typical Schematic

NCP566

ELECTRICAL CHARACTERISTICS ($V_{in} = V_{out} + 1.6\text{ V}$, for typical values $T_J = 25^\circ\text{C}$, for min/max values $T_J = -40^\circ\text{C}$ to $+125^\circ\text{C}$, (Note 4) unless otherwise noted.)

Characteristic	Symbol	Min	Typ	Max	Unit
Output Voltage (10 mA < I_{out} < 1.5 A; 2.8 V < V_{in} < 9.0 V; $T_J = -10$ to 105°C) 1.2 V version	V_{out}	1.176 (-2%)	1.2	1.224 (+2%)	V
Output Voltage (10 mA < I_{out} < 1.5 A; 2.8 V < V_{in} < 9.0 V; $T_J = -40$ to 125°C) 1.2 V version	V_{out}	1.164 (-3%)	1.2	1.236 (+3%)	V
Output Voltage (10 mA < I_{out} < 1.5 A; 3.4 V < V_{in} < 9.0 V; $T_J = -10$ to 105°C) 1.8 V version	V_{out}	1.764 (-2%)	1.8	1.836 (+2%)	V
Output Voltage (10 mA < I_{out} < 1.5 A; 3.4 V < V_{in} < 9.0 V; $T_J = -40$ to 125°C) 1.8 V version	V_{out}	1.746 (-3%)	1.8	1.854 (+3%)	V
Output Voltage (10 mA < I_{out} < 1.5 A; 4.1 V < V_{in} < 9.0 V; $T_J = -10$ to 105°C) 2.5 V version	V_{out}	2.450 (-2%)	2.5	2.550 (+2%)	V
Output Voltage (10 mA < I_{out} < 1.5 A; 4.1 V < V_{in} < 9.0 V; $T_J = -40$ to 125°C) 2.5 V version	V_{out}	2.425 (-3%)	2.5	2.575 (+3%)	V
Line Regulation ($I_{out} = 10\text{ mA}$)	Reg_{line}	-	0.02	-	%
Load Regulation (10 mA < I_{out} < 1.5 A)	Reg_{load}	-	0.04	-	%
Dropout Voltage ($I_{out} = 1.5\text{ A}$) (Note 5)	V_{do}	-	0.9	1.3	V
Current Limit	I_{lim}	1.6	3.5	-	A
Ripple Rejection (120 Hz; $I_{out} = 1.5\text{ A}$)	RR	-	85	-	dB
Ripple Rejection (1 kHz; $I_{out} = 1.5\text{ A}$)	RR	-	75	-	dB
Thermal Shutdown		-	160	-	$^\circ\text{C}$
Ground Current ($I_{out} = 1.5\text{ A}$)	I_q	-	1.5	3.0	mA
Output Noise Voltage ($f = 100\text{ Hz}$ to 100 kHz , $I_{out} = 1.5\text{ A}$)	V_n	-	37	-	μV_{rms}

4. Refer to Application Information section for capacitor details.

5. Dropout voltage is a measurement of the minimum input/output differential at full load.

NCP566

TYPICAL CHARACTERISTICS

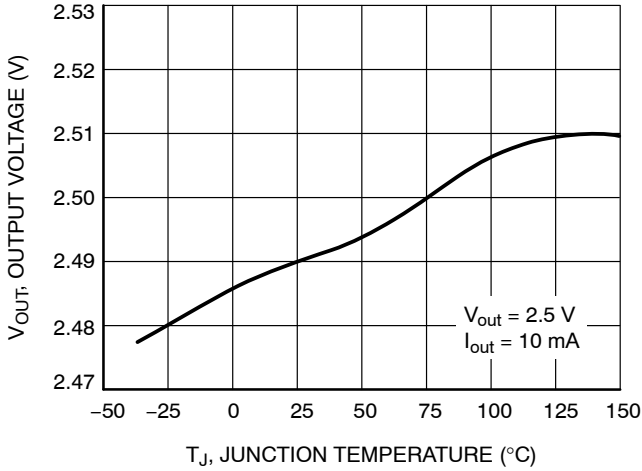

Figure 2. Output Voltage vs. Temperature

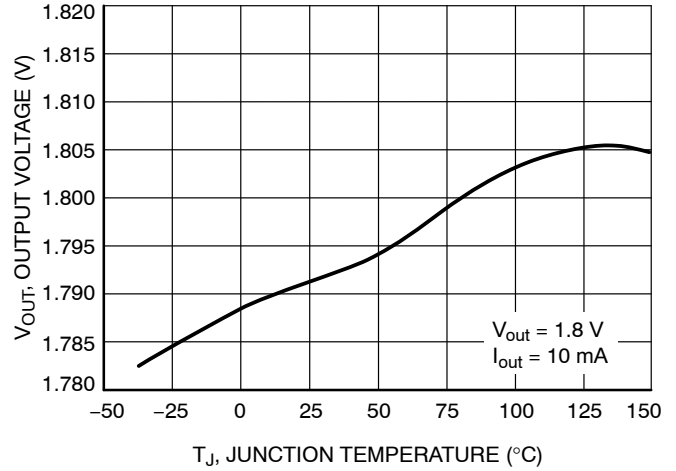

Figure 3. Output Voltage vs. Temperature

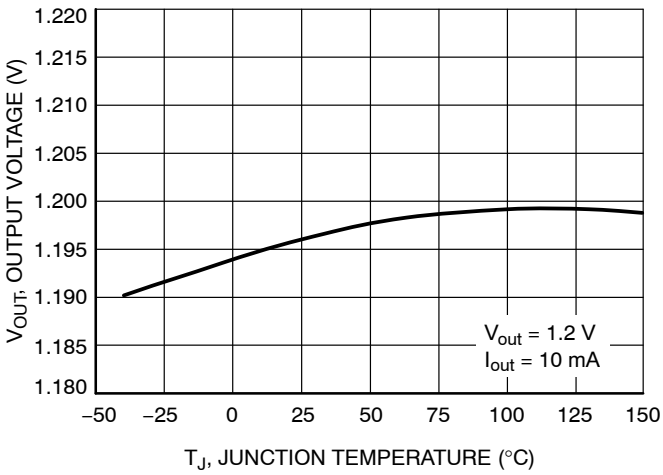

Figure 4. Output Voltage vs. Temperature

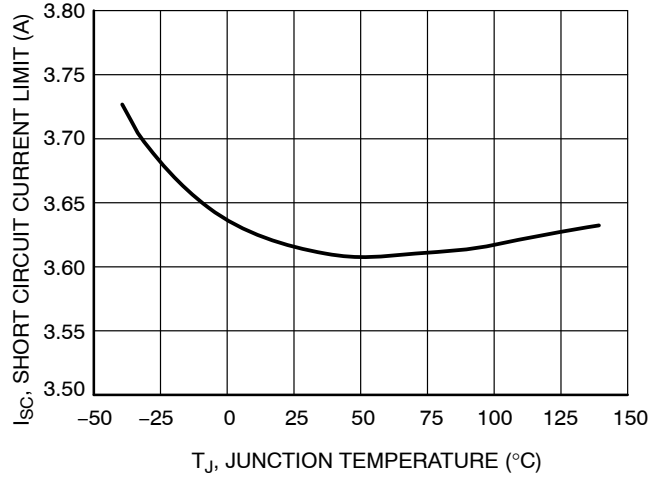

Figure 5. Short Circuit Current Limit vs. Temperature

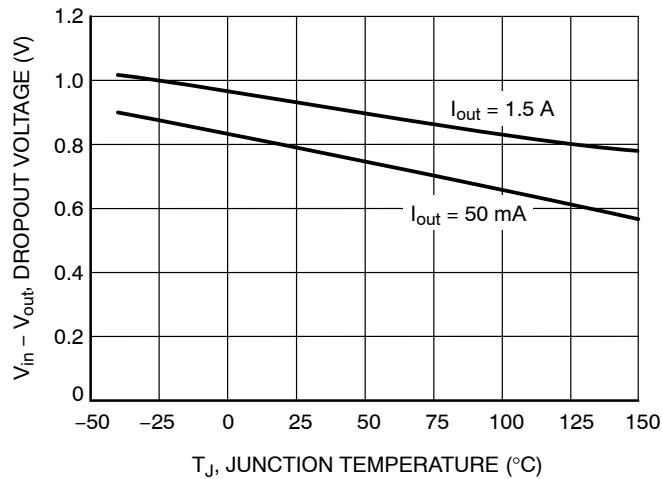

Figure 6. Dropout Voltage vs. Temperature

NCP566

TYPICAL CHARACTERISTICS

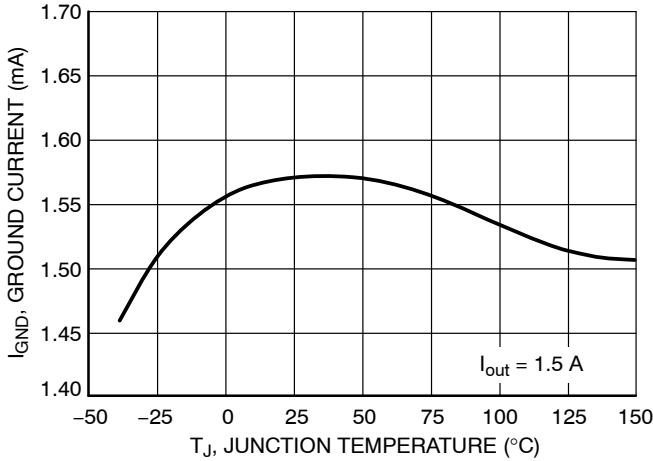

Figure 7. Ground Current vs. Temperature

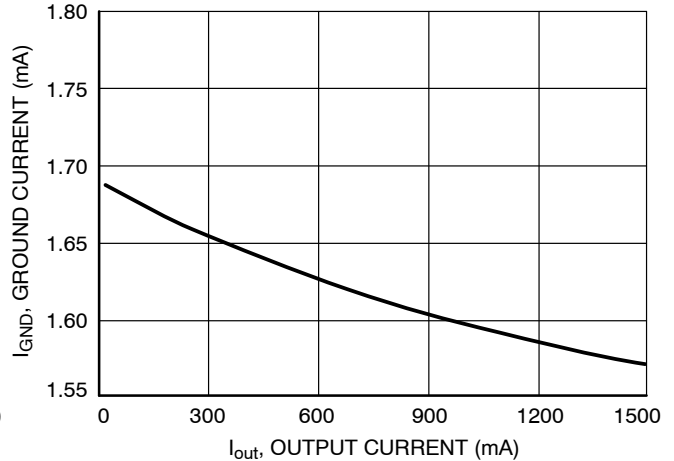

Figure 8. Ground Current vs. Output Current

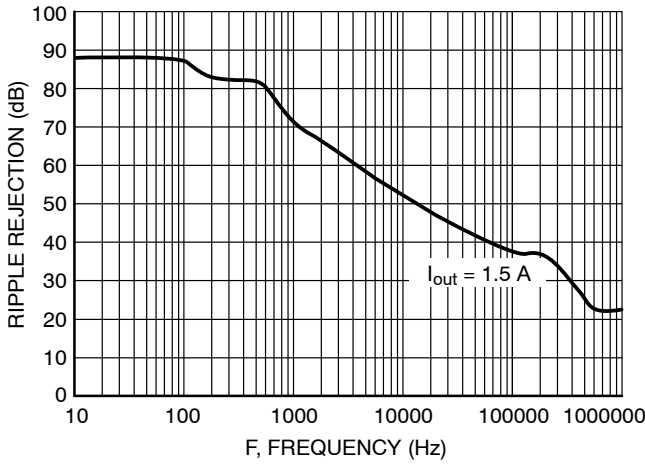

Figure 9. Ripple Rejection vs. Frequency

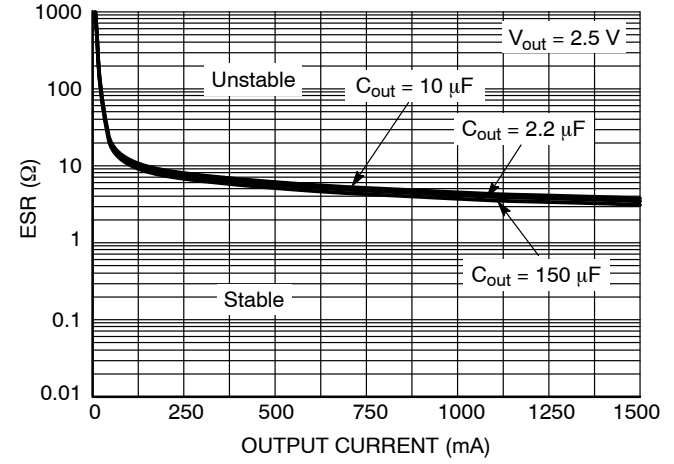

Figure 10. Output Capacitor ESR Stability vs. Output Current

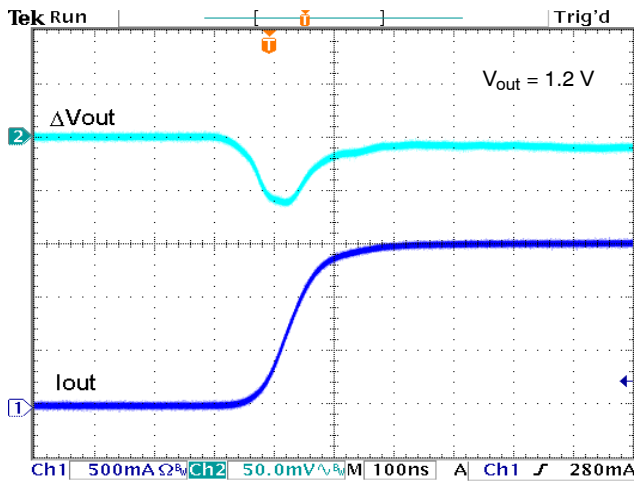

Figure 11. Load Transient from 10 mA to 1.5 A

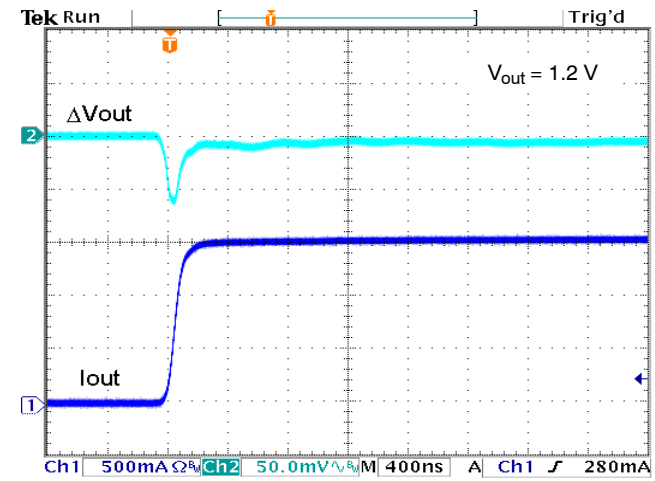

Figure 12. Load Transient from 10 mA to 1.5 A

NCP566

TYPICAL CHARACTERISTICS

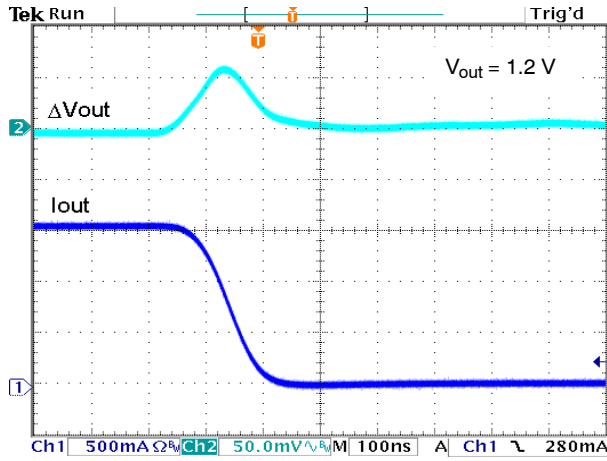

Figure 13. Load Transient from 1.5 A to 10 mA

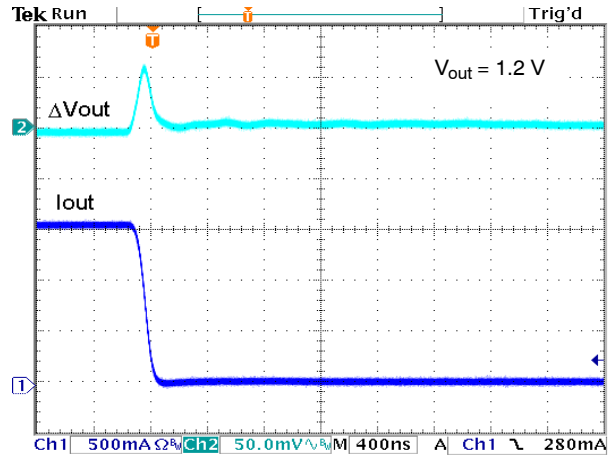

Figure 14. Load Transient from 1.5 A to 10 mA

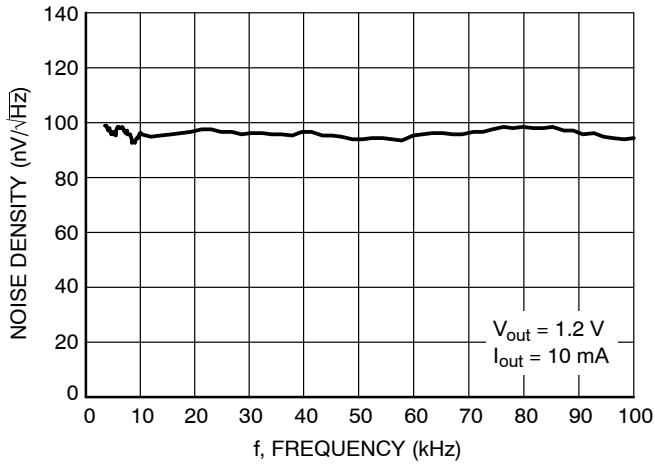

Figure 15. Noise Density vs. Frequency

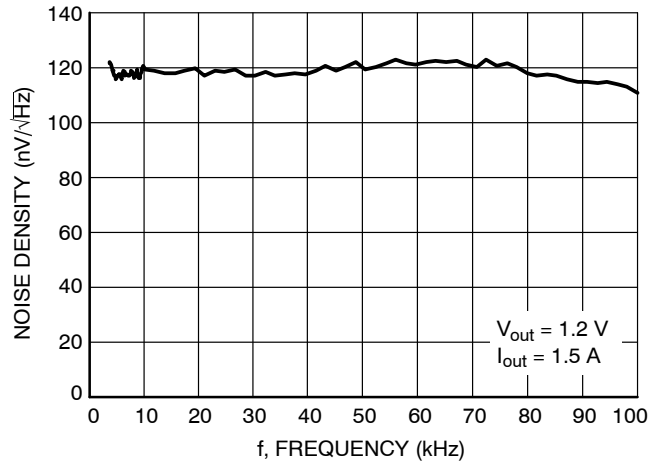

Figure 16. Noise Density vs. Frequency

APPLICATION INFORMATION

The NCP566 low dropout linear regulator provides fixed voltages at currents up to 1.5 A. It features ultra fast transient response and low dropout voltage. These devices contain output current limiting, short circuit protection and thermal shutdown protection.

Input, Output Capacitor and Stability

Typical values of parameters in Electrical Characteristics section and in Typical Characteristics section were measured with input and output capacitors equal to 150 μF unless otherwise noted.

An input bypass capacitor is recommended to improve transient response or if the regulator is located more than a few inches from the power source. This will reduce the circuit's sensitivity to the input line impedance at high frequencies and significantly enhance the output transient response. Different types and different sizes of input capacitors can be chosen dependent on the quality of power supply. The range of 4.7 μF to 150 μF should cover most of the applications. The higher capacitance the lower change of input voltage due to line and load transients. The bypass capacitor should be mounted with shortest possible lead or track length directly across the regulator's input terminals.

The output capacitor is required for stability. The NCP566 remains stable with ceramic, tantalum, and aluminum-electrolytic capacitors with a minimum value of 1.0 μF with ESR between 50 m Ω and 2.5 Ω . The range of 2.2 μF to

150 μF should cover most of the applications. The higher capacitance the better load transient response. When a high value capacitor is used, a low value capacitor is also recommended to be put in parallel. The NCP566 is optimized for use with a 150 μF OSCON 16SA150M type in parallel with a 10 μF OSCON 10SL10M type from Sanyo. The 10 μF capacitor is used for best AC stability while 150 μF capacitor is used for achieving excellent load transient response. The output capacitors should be placed as close as possible to the output pin of the device. If not, the excellent load transient response of NCP566 will be degraded.

Load Transient Measurement

Large load current changes are always presented in microprocessor applications. Therefore good load transient performance is required for the power stage. NCP566 has the feature of ultra fast transient response. Its load transient responses in Figures 11 through 14 are tested on evaluation board shown in Figure 17. The evaluation board consists of NCP566 regulator circuit with decoupling and filter capacitors and the pulse controlled current sink to obtain load current transitions. The load current transitions are measured by current probe. Because the signal from current probe has some time delay, it causes un-synchronization between the load current transition and output voltage response, which is shown in Figures 11 through 14.

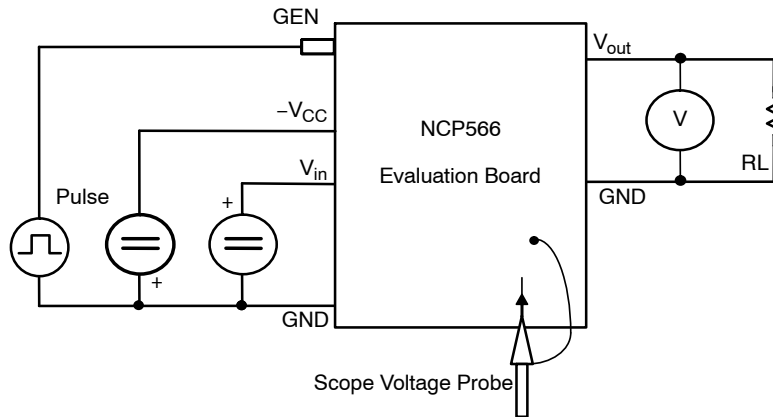

Figure 17. Schematic for Transient Response Measurement

PCB Layout Considerations

Good PCB layout plays an important role in achieving good load transient performance. Because it is very sensitive to its PCB layout, particular care has to be taken when tackling Printed Circuit Board (PCB) layout. For microprocessor applications it is customary to use an output capacitor network consisting of several capacitors in parallel. This reduces the overall ESR and reduces the instantaneous output voltage drop under transient load conditions. The output capacitor network should be as close as possible to the load for the best results.

Protection Diodes

When large external capacitors are used with a linear regulator it is sometimes necessary to add protection diodes. If the input voltage of the regulator gets shorted, the output capacitor will discharge into the output of the regulator. The discharge current depends on the value of the capacitor, the output voltage and the rate at which V_{in} drops. In the NCP566 linear regulator, the discharge path is through a large junction and protection diodes are not usually needed. If the regulator is used with large values of output capacitance and the input voltage is instantaneously shorted to ground, damage can occur. In this case, a diode connected as shown in Figure 18 is recommended.

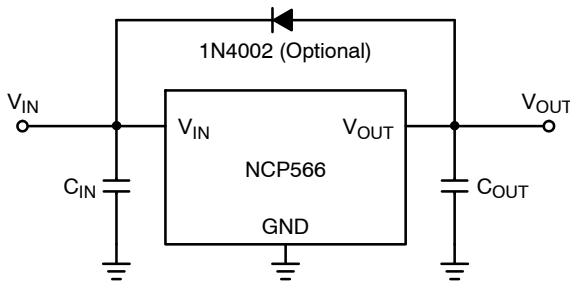

Figure 18. Protection Diode for Large Output Capacitors

Thermal Considerations

This series contains an internal thermal limiting circuit that is designed to protect the regulator in the event that the maximum junction temperature is exceeded. This feature provides protection from a catastrophic device failure due to accidental overheating. It is not intended to be used as a substitute for proper heat sinking. The maximum device power dissipation can be calculated by:

$$P_D = \frac{T_{J(max)} - T_A}{R_{\theta JA}}$$

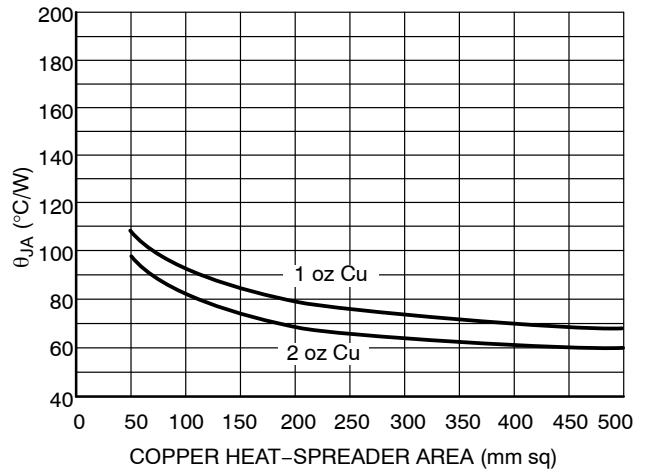

Figure 19. Thermal Resistance

NCP566

ORDERING INFORMATION

Device	Nominal Output Voltage*	Package	Shipping†
NCP566ST12T3G	1.2 V	SOT-223 (Pb-Free)	4000 / Tape & Reel
NCP566ST18T3G	1.8 V	SOT-223 (Pb-Free)	4000 / Tape & Reel
NCP566ST25T3G	2.5 V	SOT-223 (Pb-Free)	4000 / Tape & Reel

*For other fixed output versions, please contact the factory.

†For information on tape and reel specifications, including part orientation and tape sizes, please refer to our Tape and Reel Packaging Specifications Brochure, BRD8011/D.

The product described herein (NCP566), may be covered by one or more of the following U.S. patents: 5,920,184; 5,834,926.
There may be other patents pending.

MECHANICAL CASE OUTLINE

PACKAGE DIMENSIONS

ON Semiconductor®



SCALE 1:1

SOT-223 (TO-261)
CASE 318E-04
ISSUE R

DATE 02 OCT 2018

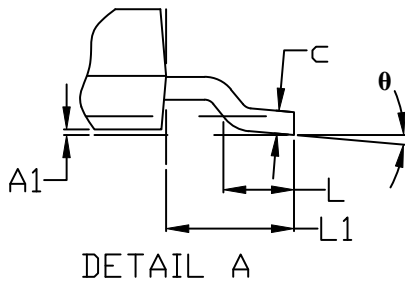
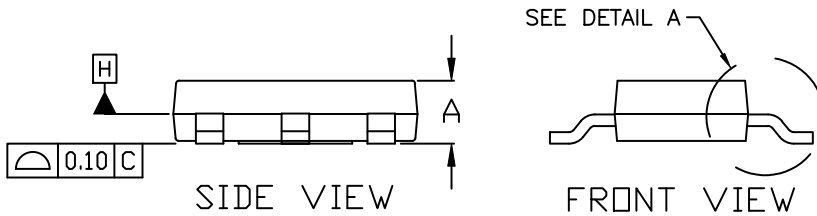
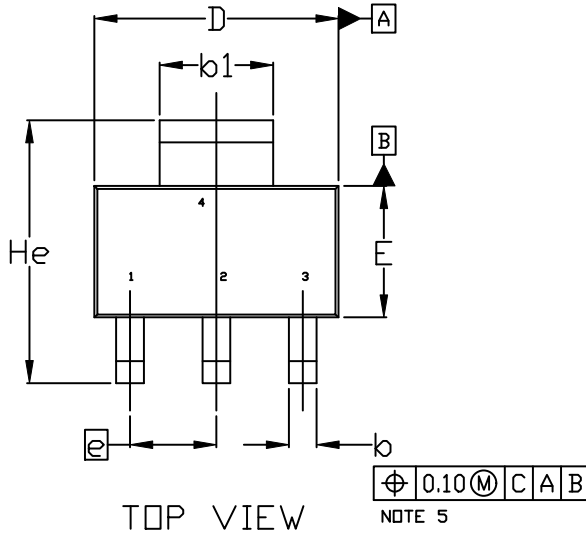

NOTES:

1. DIMENSIONING AND TOLERANCING PER ASME Y14.5M, 1994.
2. CONTROLLING DIMENSION: MILLIMETERS
3. DIMENSIONS D & E DO NOT INCLUDE MOLD FLASH, PROTRUSIONS OR GATE BURRS. MOLD FLASH, PROTRUSIONS OR GATE BURRS SHALL NOT EXCEED 0.200MM PER SIDE.
4. DATUMS A AND B ARE DETERMINED AT DATUM H.
5. A1 IS DEFINED AS THE VERTICAL DISTANCE FROM THE SEATING PLANE TO THE LOWEST POINT OF THE PACKAGE BODY.
6. POSITIONAL TOLERANCE APPLIES TO DIMENSIONS b AND b1.

MILLIMETERS			
DIM	MIN.	NOM.	MAX.
A	1.50	1.63	1.75
A1	0.02	0.06	0.10
b	0.60	0.75	0.89
b1	2.90	3.06	3.20
c	0.24	0.29	0.35
D	6.30	6.50	6.70
E	3.30	3.50	3.70
e	2.30 BSC		
L	0.20	---	---
L1	1.50	1.75	2.00
He	6.70	7.00	7.30
θ	0°	---	10°

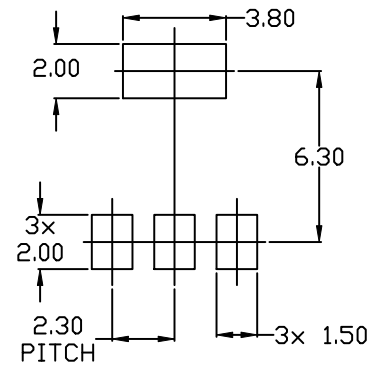

DOCUMENT NUMBER:	98ASB42680B	Electronic versions are uncontrolled except when accessed directly from the Document Repository. Printed versions are uncontrolled except when stamped "CONTROLLED COPY" in red.
DESCRIPTION:	SOT-223 (TO-261)	PAGE 1 OF 2

ON Semiconductor and are trademarks of Semiconductor Components Industries, LLC dba ON Semiconductor or its subsidiaries in the United States and/or other countries. ON Semiconductor reserves the right to make changes without further notice to any products herein. ON Semiconductor makes no warranty, representation or guarantee regarding the suitability of its products for any particular purpose, nor does ON Semiconductor assume any liability arising out of the application or use of any product or circuit, and specifically disclaims any and all liability, including without limitation special, consequential or incidental damages. ON Semiconductor does not convey any license under its patent rights nor the rights of others.

SOT-223 (TO-261)
CASE 318E-04
ISSUE R

DATE 02 OCT 2018

- | | | | | |
|------------------------------------------------------------------------------|-----------------------------------------------------------------------------|-------------------------------------------------------------------------------|-----------------------------------------------------------------------|-----------------------------------------------------------------------|
| STYLE 1:
PIN 1. BASE
2. COLLECTOR
3. EMITTER
4. COLLECTOR | STYLE 2:
PIN 1. ANODE
2. CATHODE
3. NC
4. CATHODE | STYLE 3:
PIN 1. GATE
2. DRAIN
3. SOURCE
4. DRAIN | STYLE 4:
PIN 1. SOURCE
2. DRAIN
3. GATE
4. DRAIN | STYLE 5:
PIN 1. DRAIN
2. GATE
3. SOURCE
4. GATE |
| STYLE 6:
PIN 1. RETURN
2. INPUT
3. OUTPUT
4. INPUT | STYLE 7:
PIN 1. ANODE 1
2. CATHODE
3. ANODE 2
4. CATHODE | STYLE 8:
CANCELLED | STYLE 9:
PIN 1. INPUT
2. GROUND
3. LOGIC
4. GROUND | STYLE 10:
PIN 1. CATHODE
2. ANODE
3. GATE
4. ANODE |
| STYLE 11:
PIN 1. MT 1
2. MT 2
3. GATE
4. MT 2 | STYLE 12:
PIN 1. INPUT
2. OUTPUT
3. NC
4. OUTPUT | STYLE 13:
PIN 1. GATE
2. COLLECTOR
3. EMITTER
4. COLLECTOR | | |

**GENERIC
 MARKING DIAGRAM***

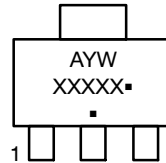

- A = Assembly Location
- Y = Year
- W = Work Week
- XXXXX = Specific Device Code
- = Pb-Free Package

(Note: Microdot may be in either location)

*This information is generic. Please refer to device data sheet for actual part marking. Pb-Free indicator, "G" or microdot "▪", may or may not be present. Some products may not follow the Generic Marking.

DOCUMENT NUMBER:	98ASB42680B	Electronic versions are uncontrolled except when accessed directly from the Document Repository. Printed versions are uncontrolled except when stamped "CONTROLLED COPY" in red.
DESCRIPTION:	SOT-223 (TO-261)	PAGE 2 OF 2

ON Semiconductor and  are trademarks of Semiconductor Components Industries, LLC dba ON Semiconductor or its subsidiaries in the United States and/or other countries. ON Semiconductor reserves the right to make changes without further notice to any products herein. ON Semiconductor makes no warranty, representation or guarantee regarding the suitability of its products for any particular purpose, nor does ON Semiconductor assume any liability arising out of the application or use of any product or circuit, and specifically disclaims any and all liability, including without limitation special, consequential or incidental damages. ON Semiconductor does not convey any license under its patent rights nor the rights of others.

onsemi, **Onsemi**, and other names, marks, and brands are registered and/or common law trademarks of Semiconductor Components Industries, LLC dba "**onsemi**" or its affiliates and/or subsidiaries in the United States and/or other countries. **onsemi** owns the rights to a number of patents, trademarks, copyrights, trade secrets, and other intellectual property. A listing of **onsemi**'s product/patent coverage may be accessed at www.onsemi.com/site/pdf/Patent-Marking.pdf. **onsemi** reserves the right to make changes at any time to any products or information herein, without notice. The information herein is provided "as-is" and **onsemi** makes no warranty, representation or guarantee regarding the accuracy of the information, product features, availability, functionality, or suitability of its products for any particular purpose, nor does **onsemi** assume any liability arising out of the application or use of any product or circuit, and specifically disclaims any and all liability, including without limitation special, consequential or incidental damages. Buyer is responsible for its products and applications using **onsemi** products, including compliance with all laws, regulations and safety requirements or standards, regardless of any support or applications information provided by **onsemi**. "Typical" parameters which may be provided in **onsemi** data sheets and/or specifications can and do vary in different applications and actual performance may vary over time. All operating parameters, including "Typicals" must be validated for each customer application by customer's technical experts. **onsemi** does not convey any license under any of its intellectual property rights nor the rights of others. **onsemi** products are not designed, intended, or authorized for use as a critical component in life support systems or any FDA Class 3 medical devices or medical devices with a same or similar classification in a foreign jurisdiction or any devices intended for implantation in the human body. Should Buyer purchase or use **onsemi** products for any such unintended or unauthorized application, Buyer shall indemnify and hold **onsemi** and its officers, employees, subsidiaries, affiliates, and distributors harmless against all claims, costs, damages, and expenses, and reasonable attorney fees arising out of, directly or indirectly, any claim of personal injury or death associated with such unintended or unauthorized use, even if such claim alleges that **onsemi** was negligent regarding the design or manufacture of the part. **onsemi** is an Equal Opportunity/Affirmative Action Employer. This literature is subject to all applicable copyright laws and is not for resale in any manner.

PUBLICATION ORDERING INFORMATION

LITERATURE FULFILLMENT:

Email Requests to: orderlit@onsemi.com

onsemi Website: www.onsemi.com

TECHNICAL SUPPORT

North American Technical Support:

Voice Mail: 1 800-282-9855 Toll Free USA/Canada

Phone: 011 421 33 790 2910

Europe, Middle East and Africa Technical Support:

Phone: 00421 33 790 2910

For additional information, please contact your local Sales Representative

X-ON Electronics

Largest Supplier of Electrical and Electronic Components

Click to view similar products for [LDO Voltage Regulators](#) category:

Click to view products by [ON Semiconductor](#) manufacturer:

Other Similar products are found below :

[AP7363-SP-13](#) [L79M05TL-E](#) [PT7M8202B12TA5EX](#) [TCR3DF185,LM\(CT](#) [TCR3DF24,LM\(CT](#) [TCR3DF285,LM\(CT](#) [TCR3DF31,LM\(CT](#)
[TCR3DF45,LM\(CT](#) [MP2013GQ-33-Z](#) [059985X](#) [NCP4687DH15T1G](#) [701326R](#) [TCR2EN28,LF\(S](#) [NCV8170AXV250T2G](#)
[TCR3DF27,LM\(CT](#) [TCR3DF19,LM\(CT](#) [TCR3DF125,LM\(CT](#) [TCR2EN18,LF\(S](#) [AP2112R5A-3.3TRG1](#) [AP7315-25W5-7](#)
[IFX30081LDVGRNXUMA1](#) [NCV47411PAAJR2G](#) [AP2113KTR-G1](#) [AP2111H-1.2TRG1](#) [ZLDO1117QK50TC](#) [AZ1117IH-1.8TRG1](#)
[AZ1117ID-ADJTRG1](#) [TCR3DG12,LF](#) [MIC5514-3.3YMT-T5](#) [MIC5512-1.2YMT-T5](#) [MIC5317-2.8YM5-T5](#) [SCD7912BTG](#)
[NCP154MX180270TAG](#) [SCD33269T-5.0G](#) [NCV8170BMX330TCG](#) [NCV8170AMX120TCG](#) [NCP706ABMX300TAG](#)
[NCP153MX330180TCG](#) [NCP114BMX075TCG](#) [MC33269T-3.5G](#) [CAT6243-ADJCMT5T](#) [TCR3DG33,LF](#) [AP2127N-1.0TRG1](#)
[TCR4DG35,LF](#) [LT1117CST-3.3](#) [LT1117CST-5](#) [TAR5S15U\(TE85L,F\)](#) [TAR5S18U\(TE85L,F\)](#) [TCR3UG19A,LF](#) [TCR4DG105,LF](#)