

NCP584

Tri-Mode 200 mA CMOS LDO Regulator with Enable

The NCP584 series of low drop out regulators are designed for portable battery powered applications which require precise output voltage accuracy, low quiescent current, and high ripple rejection. These devices feature an enable function which lowers current consumption significantly and are offered in the SOT23-5 package.

This series of devices have three modes. Chip Enable (CE mode), Fast Transient Mode (FT mode), and Low Power Mode (LP mode). Both the FT and LP mode are utilized via the ECO pin.

Features

- Tri-mode Operation
- Low Dropout Voltage of 400 mV at 200 mA, Output Voltage = 0.9 V
300 mV at 200 mA, Output Voltage = 1.2 V
200 mV at 200 mA, Output Voltage = 1.8 V
- Excellent Line Regulation of 0.05%/V (0.10% LP Mode)
- Excellent Load Regulation of 10 mV (20 mV FT Mode)
- High Output Voltage Accuracy of $\pm 2\%$ ($\pm 3\%$ LP mode)
- Ultra-Low Iq Current of:
3.5 μA (LP mode, Output Voltage ≤ 1.5 V)
40 μA (FT mode)
- Very Low Shutdown Current of 0.1 μA
- Excellent Power Supply Rejection Ratio of 75 dB at $f = 1.0$ kHz
- Low Temperature Drift Coefficient on the Output Voltage of ± 100 ppm/ $^{\circ}\text{C}$
- Fold Back Protection Circuit
- Input Voltage up to 6.5 V
- These are Pb-Free Devices

Typical Applications

- Portable Equipment
- Hand-Held Instrumentation
- Camcorders and Cameras

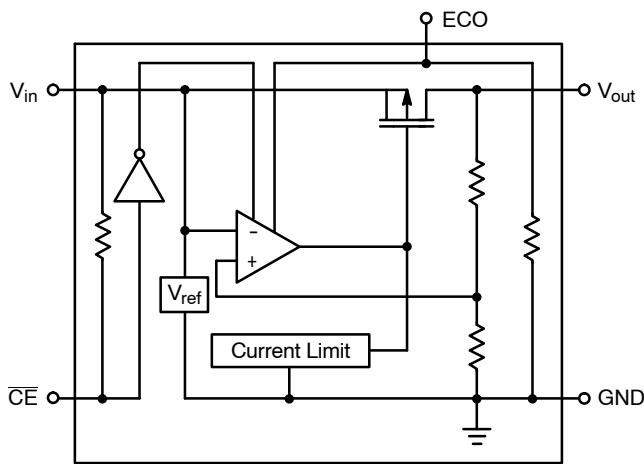

Figure 1. Simplified Block Diagram for Active Low

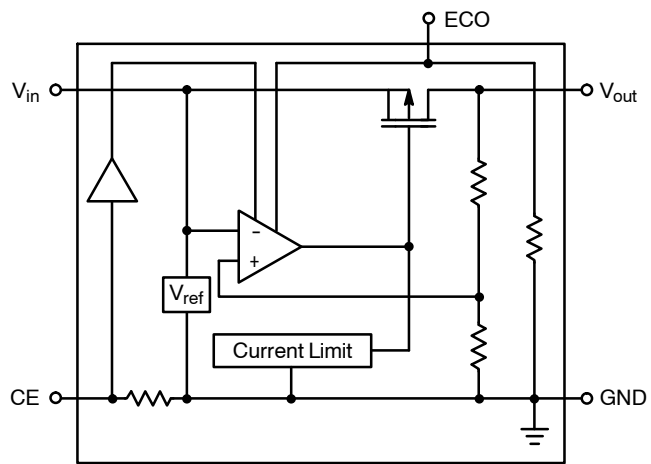

Figure 2. Simplified Block Diagram for Active High



ON Semiconductor®

<http://onsemi.com>

MARKING DIAGRAM



SOT23-5
SN SUFFIX
CASE 1212

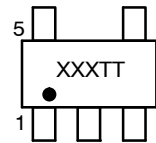

XXX = Specific Device Code
TT = Traceability Information

ORDERING INFORMATION

See detailed ordering and shipping information in the package dimensions section on page 13 of this data sheet.

*Additional voltage options may be available between 0.8 V and 3.3 V in 100 mV steps.

NCP584

PIN FUNCTION DESCRIPTION

SOT23-5	Pin Name	Description
1	V_{in}	Power supply input voltage.
2	GND	Power supply ground.
3	\overline{CE} or CE	Chip enable pin.
4	ECO	Mode alternative pin. ($V_{ECO} = V_{in}$ for FT mode; $V_{ECO} = GND$ for LP mode)
5	V_{out}	Regulated output voltage.

MAXIMUM RATINGS

Rating	Symbol	Value	Unit
Input Voltage	V_{in}	6.5	V
Input Voltage (\overline{CE} or CE Pin)	V_{CE}	-0.3 to $V_{in} + 0.3$	V
Input Voltage (ECO Pin)	V_{ECO}	-0.3 to $V_{in} + 0.3$	V
Output Voltage	V_{out}	-0.3 to $V_{in} + 0.3$	V
Output Current	I_{out}	250	mA
Power Dissipation	P_D	250	mW
ESD Capability, Human Body Model, C = 100 pF, R = 1.5 k Ω	ESD _{HBM}	1000	V
ESD Capability, Machine Model, C = 200 pF, R = 0 Ω	ESD _{MM}	150	V
Operating Ambient Temperature Range	T_A	-40 to +85	°C
Maximum Junction Temperature	$T_{J(max)}$	125	°C
Storage Temperature Range	T_{stg}	-55 to +150	°C

Stresses exceeding Maximum Ratings may damage the device. Maximum Ratings are stress ratings only. Functional operation above the Recommended Operating Conditions is not implied. Extended exposure to stresses above the Recommended Operating Conditions may affect device reliability.

NCP584

ELECTRICAL CHARACTERISTICS ($V_{in} = V_{out} + 1.0\text{ V}$, $T_A = 25^\circ\text{C}$, unless otherwise noted.)

Characteristic	Symbol	Min	Typ	Max	Unit
Input Voltage	V_{in}	1.4	–	6.0	V
Output Voltage ($1.0\ \mu\text{A} \leq I_{out} \leq 30\ \text{mA}$) $V_{ECO} = V_{in}$ $V_{ECO} = \text{GND}$	V_{out}	$V_{out} \times 0.980$ $V_{out} \times 0.970$	– –	$V_{out} \times 1.020$ $V_{out} \times 1.030$	V
Line Regulation ($I_{out} = 30\ \text{mA}$, $V_{out} + 0.5\ \text{V} \leq V_{in} \leq 6.0\ \text{V}$) FT Mode $V_{ECO} = V_{in}$ LP Mode $V_{ECO} = \text{GND}$	Reg_{line}	– –	0.05 0.10	0.20 0.30	%/V
Load Regulation FT Mode ($1.0\ \text{mA} \leq I_{out} \leq 200\ \text{mA}$), $V_{ECO} = V_{in}$ LP Mode ($1.0\ \text{mA} \leq I_{out} \leq 100\ \text{mA}$), $V_{ECO} = \text{GND}$	Reg_{load}	– –	20 10	40 40	mV
Dropout Voltage ($I_{out} = 200\ \text{mA}$) $V_{out} = 0.9\ \text{V}$ $1.2\ \text{V} \leq V_{out} \leq 1.5\ \text{V}$ $1.8\ \text{V} \leq V_{out} \leq 2.5\ \text{V}$ $2.6\ \text{V} \leq V_{out} \leq 3.3\ \text{V}$	V_{DO}	– – – –	0.40 0.30 0.20 0.10	0.70 0.50 0.30 0.20	V
Quiescent Current ($I_{out} = 0\ \text{mA}$) FT Mode, $V_{ECO} = V_{in}$ LP Mode, $V_{ECO} = \text{GND}$ $V_{out} \leq 1.5\ \text{V}$ $V_{out} \geq 1.8\ \text{V}$	I_q	– – –	40 3.5 4.5	70 6.0 8.0	μA
Output Current ($V_{in} - V_{out} = 0.5\ \text{V}$) $V_{in} \geq 1.5\ \text{V}$, $V_{out} = 0.9\ \text{V}$	I_{out}	200	–	–	mA
Shutdown Current ($V_{CE} = V_{in}$)	I_{SD}	–	0.1	1.0	μA
Output Short Circuit Current ($V_{out} = 0\ \text{V}$)	I_{lim}	–	50	–	mA
Enable Input Threshold Voltage High Low	$V_{th_{enh}}$ $V_{th_{enl}}$	1.0 0	– –	V_{in} 0.3	V
Ripple Rejection ($I_{out} = 30\ \text{mA}$, $V_{out} = 0.9\ \text{V}$, $V_{in} - V_{out} = 1.0\ \text{V}$) $f = 120\ \text{Hz}$ $f = 1.0\ \text{kHz}$ $f = 10\ \text{kHz}$	RR	– – –	75 75 65	– – –	dB
Output Noise Voltage (BW = 10 Hz to 100 kHz)	V_n	–	30	–	μV_{rms}
Output Voltage Temperature Coefficient ($I_{out} = 30\ \text{mA}$, $-40^\circ\text{C} \leq T_A \leq 85^\circ\text{C}$)	$\Delta V_{out}/\Delta T$	–	± 100	–	ppm/ $^\circ\text{C}$

TYPICAL CHARACTERISTICS

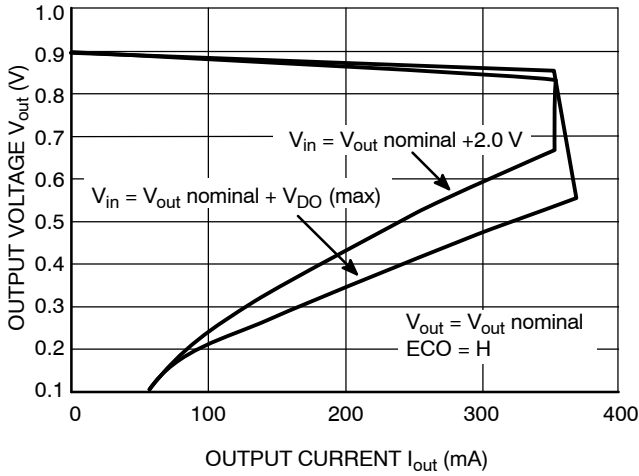

Figure 3. Output Voltage vs. Output Current

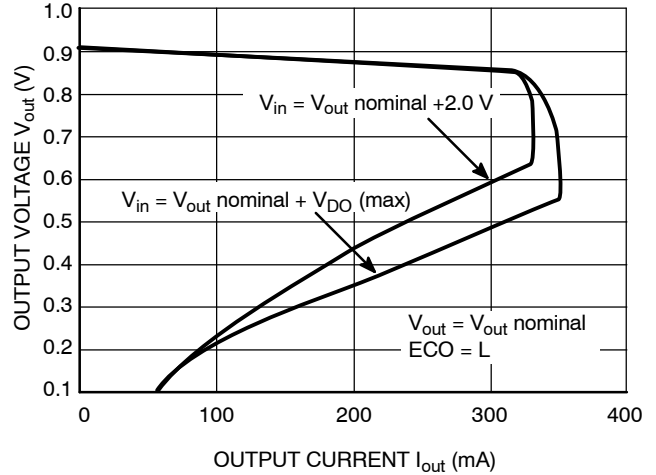

Figure 4. Output Voltage vs. Output Current

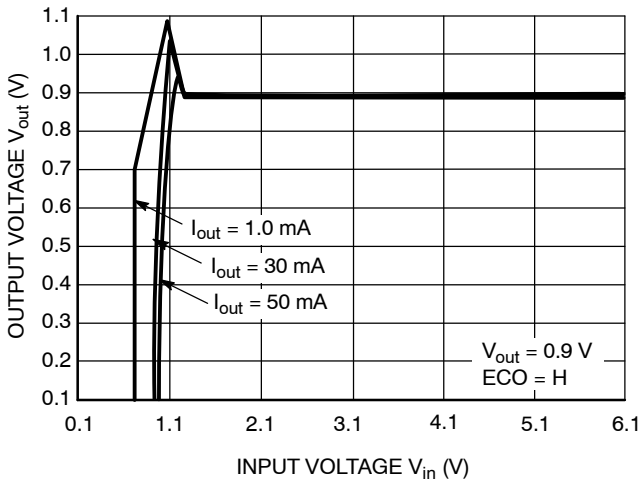

Figure 5. Output Voltage vs. Input Voltage

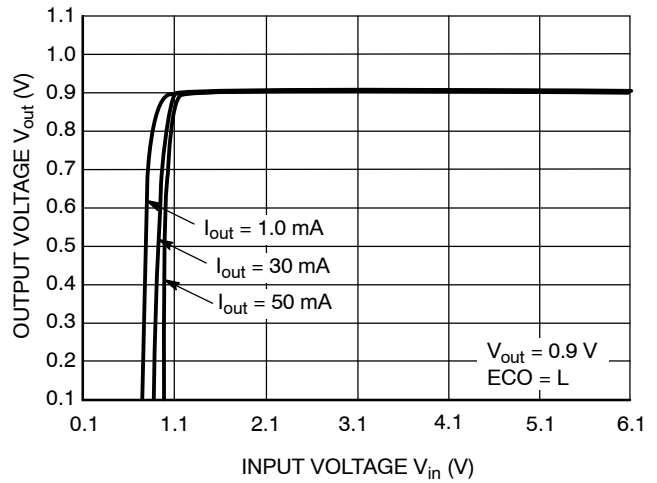

Figure 6. Output Voltage vs. Input Voltage

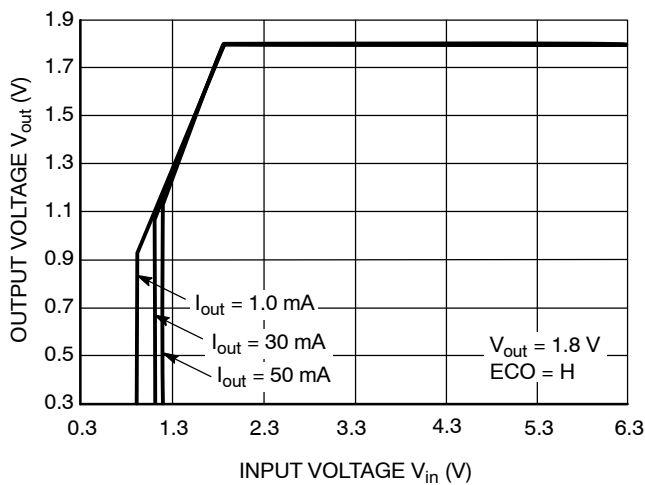

Figure 7. Output Voltage vs. Input Voltage

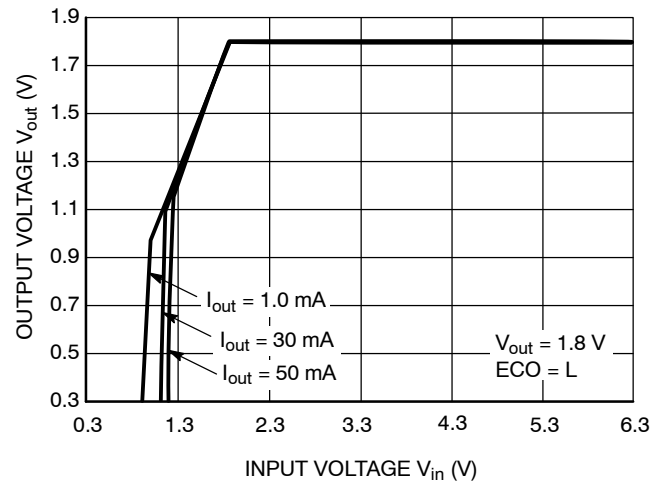

Figure 8. Output Voltage vs. Input Voltage

TYPICAL CHARACTERISTICS

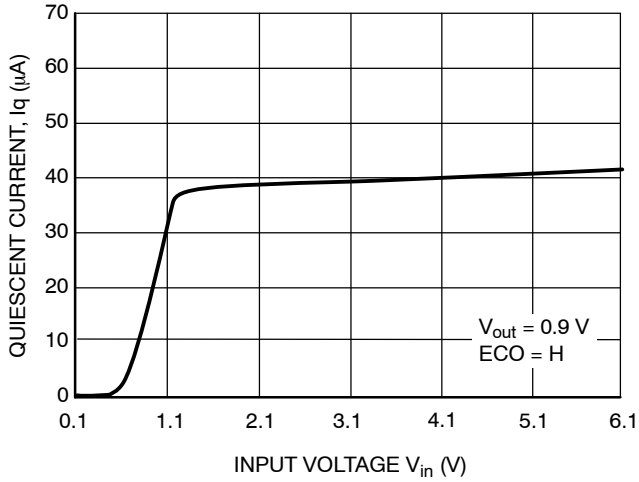

Figure 9. Quiescent Current vs. Input Voltage

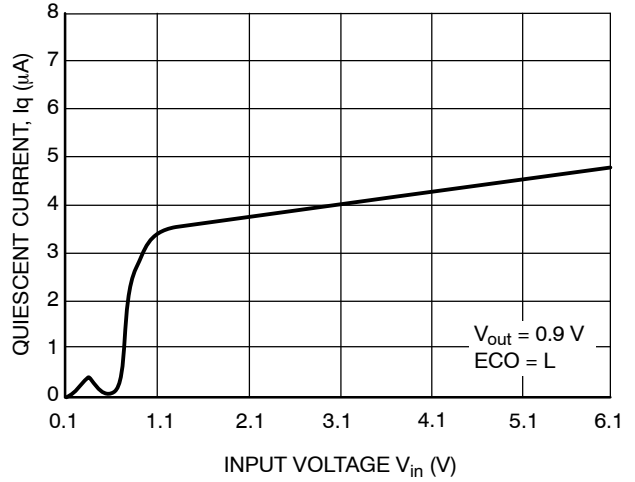

Figure 10. Quiescent Current vs. Input Voltage

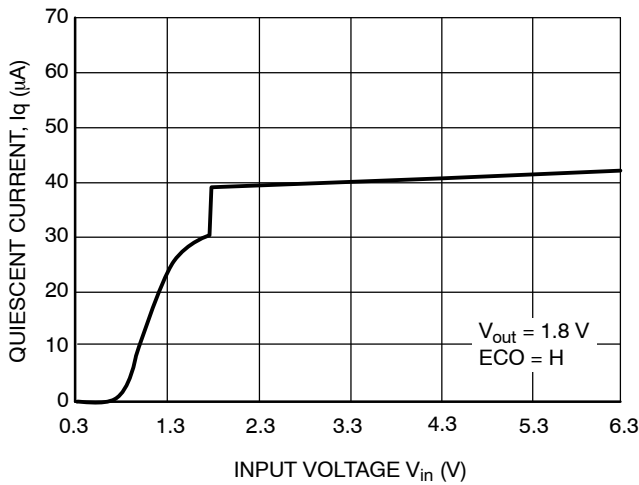

Figure 11. Quiescent Current vs. Input Voltage

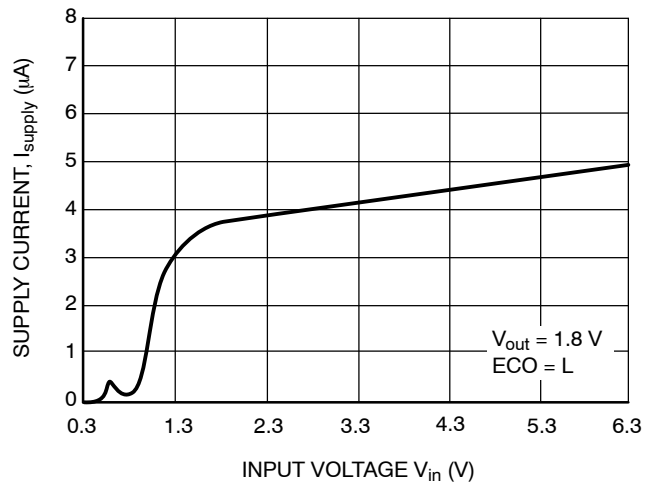

Figure 12. Quiescent Current vs. Input Voltage

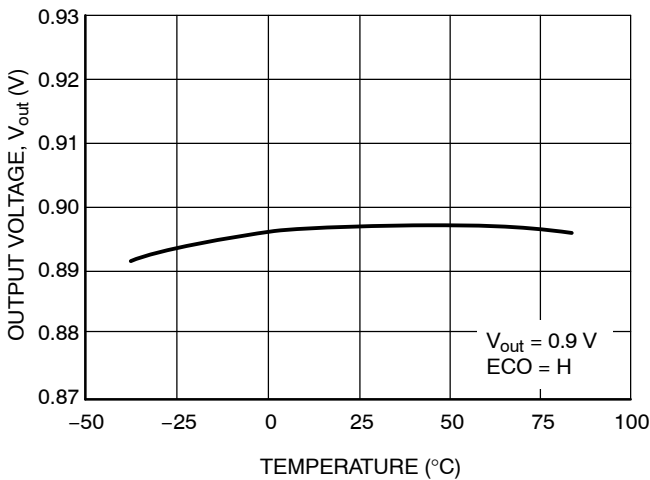

Figure 13. Output Voltage vs. Temperature

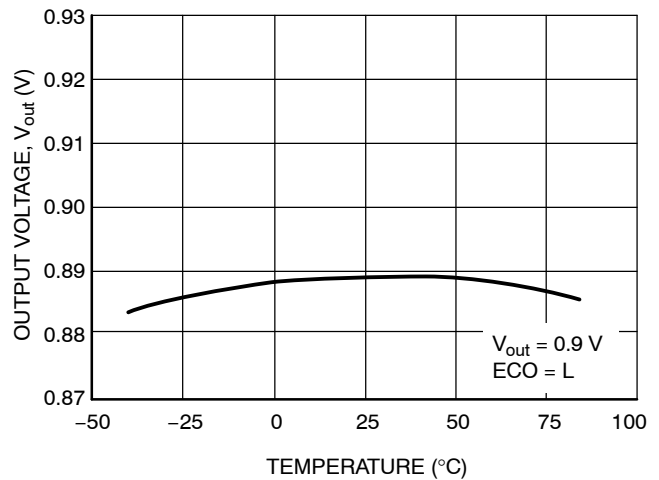

Figure 14. Output Voltage vs. Temperature

TYPICAL CHARACTERISTICS

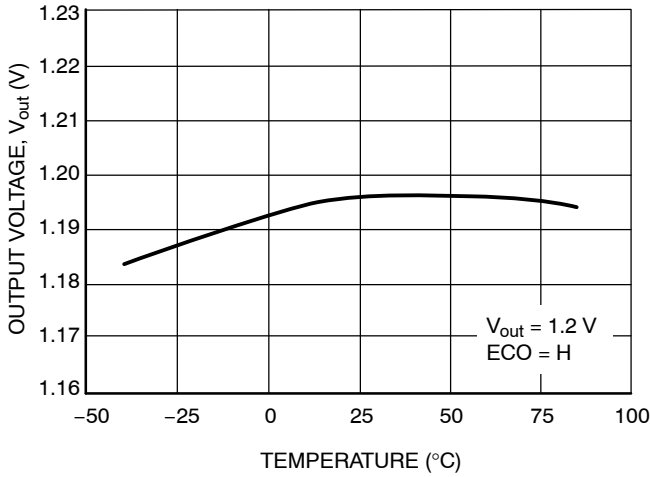

Figure 15. Output Voltage vs. Temperature

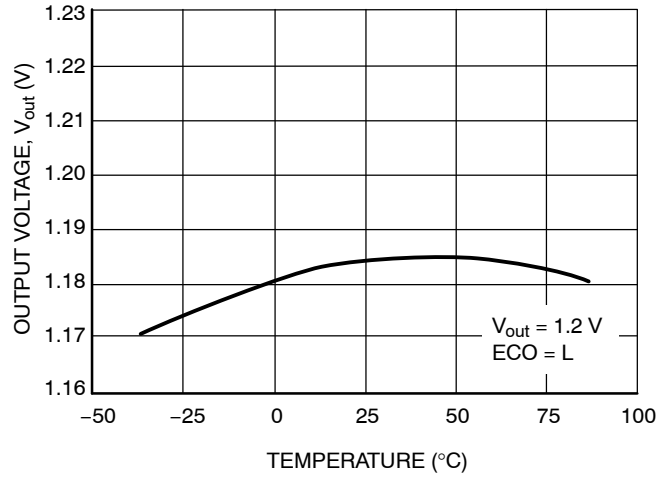

Figure 16. Output Voltage vs. Temperature

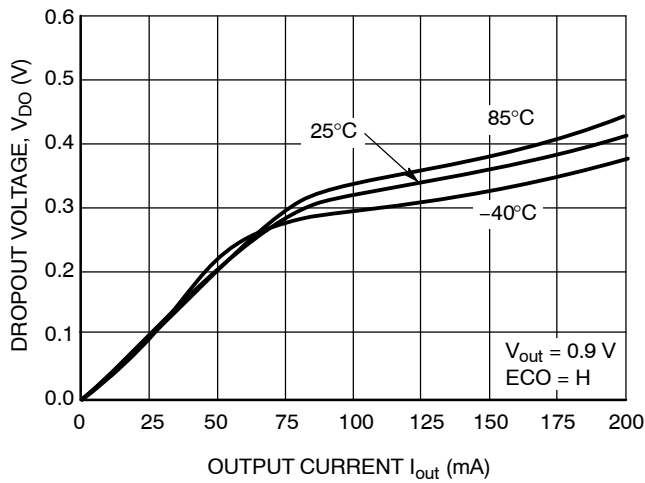

Figure 17. Dropout Voltage vs. Output Current

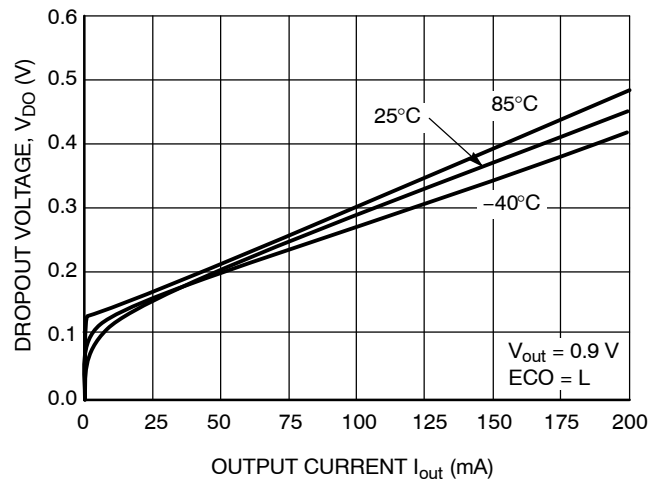

Figure 18. Dropout Voltage vs. Output Current

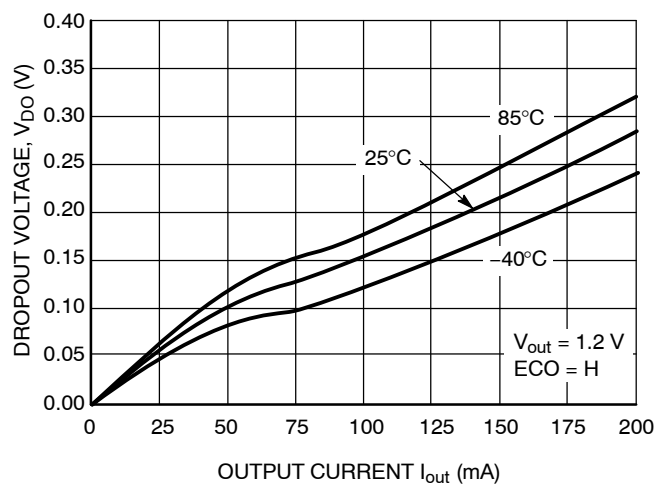

Figure 19. Dropout Voltage vs. Output Current

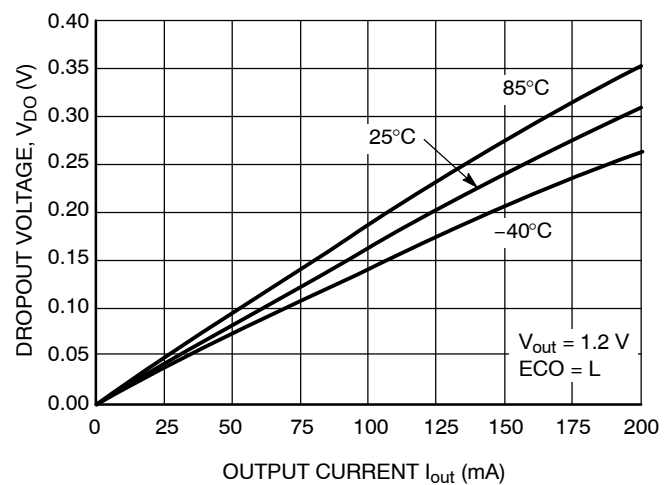

Figure 20. Dropout Voltage vs. Output Current

TYPICAL CHARACTERISTICS

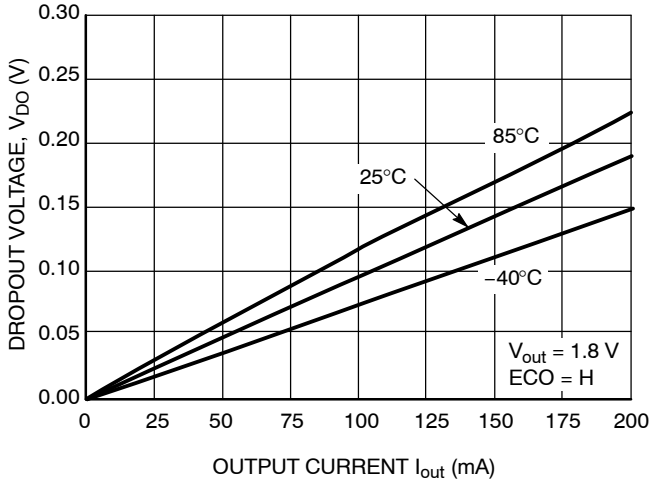

Figure 21. Dropout Voltage vs. Output Current

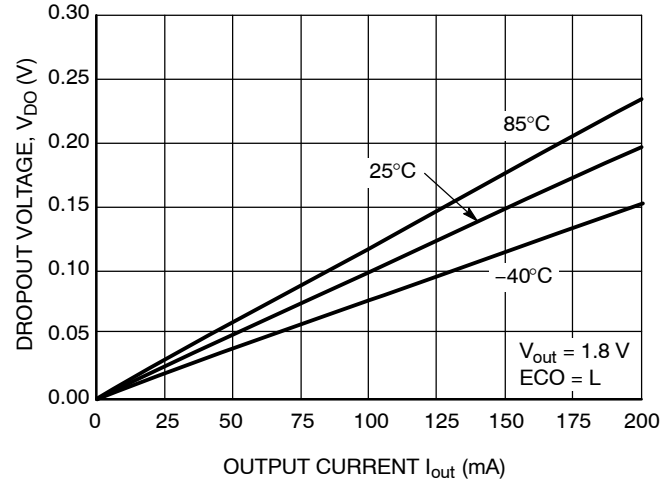

Figure 22. Dropout Voltage vs. Output Current

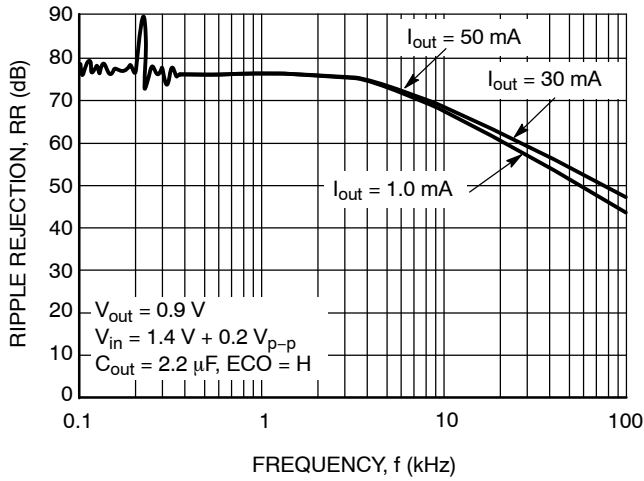

Figure 23. Ripple Rejection vs. Frequency

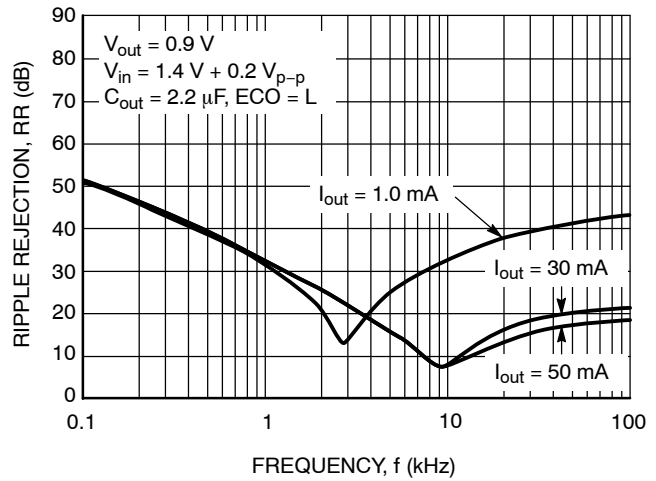

Figure 24. Ripple Rejection vs. Frequency

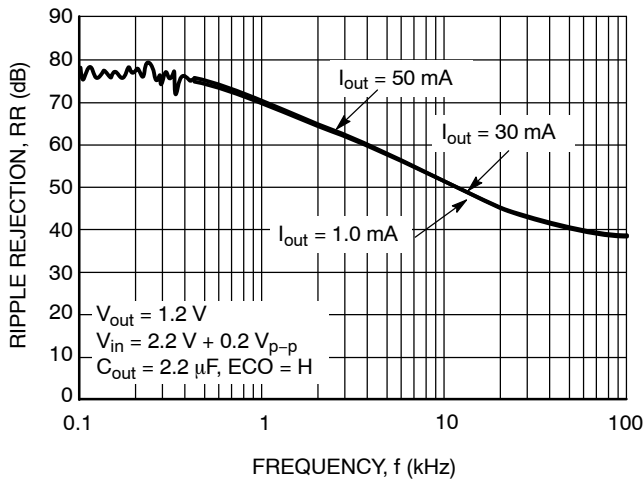

Figure 25. Ripple Rejection vs. Frequency

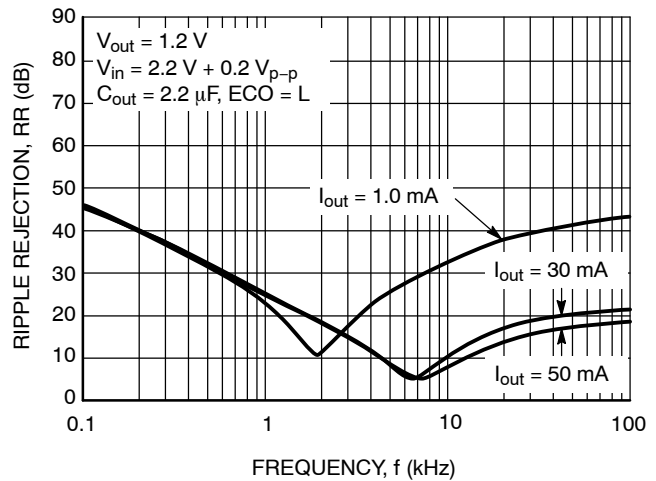

Figure 26. Ripple Rejection vs. Frequency

TYPICAL CHARACTERISTICS

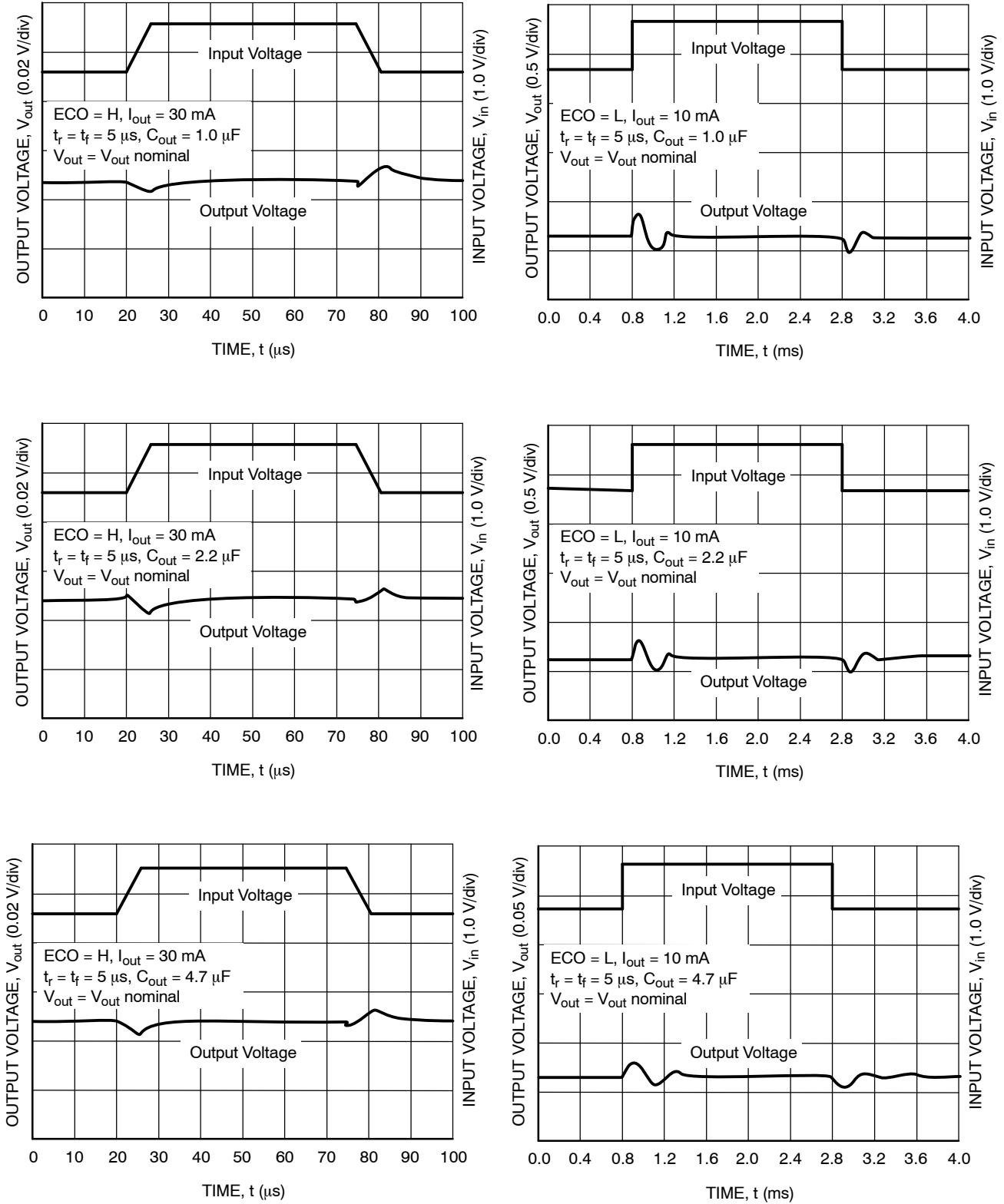

Figure 27. Input Transient Response

TYPICAL CHARACTERISTICS

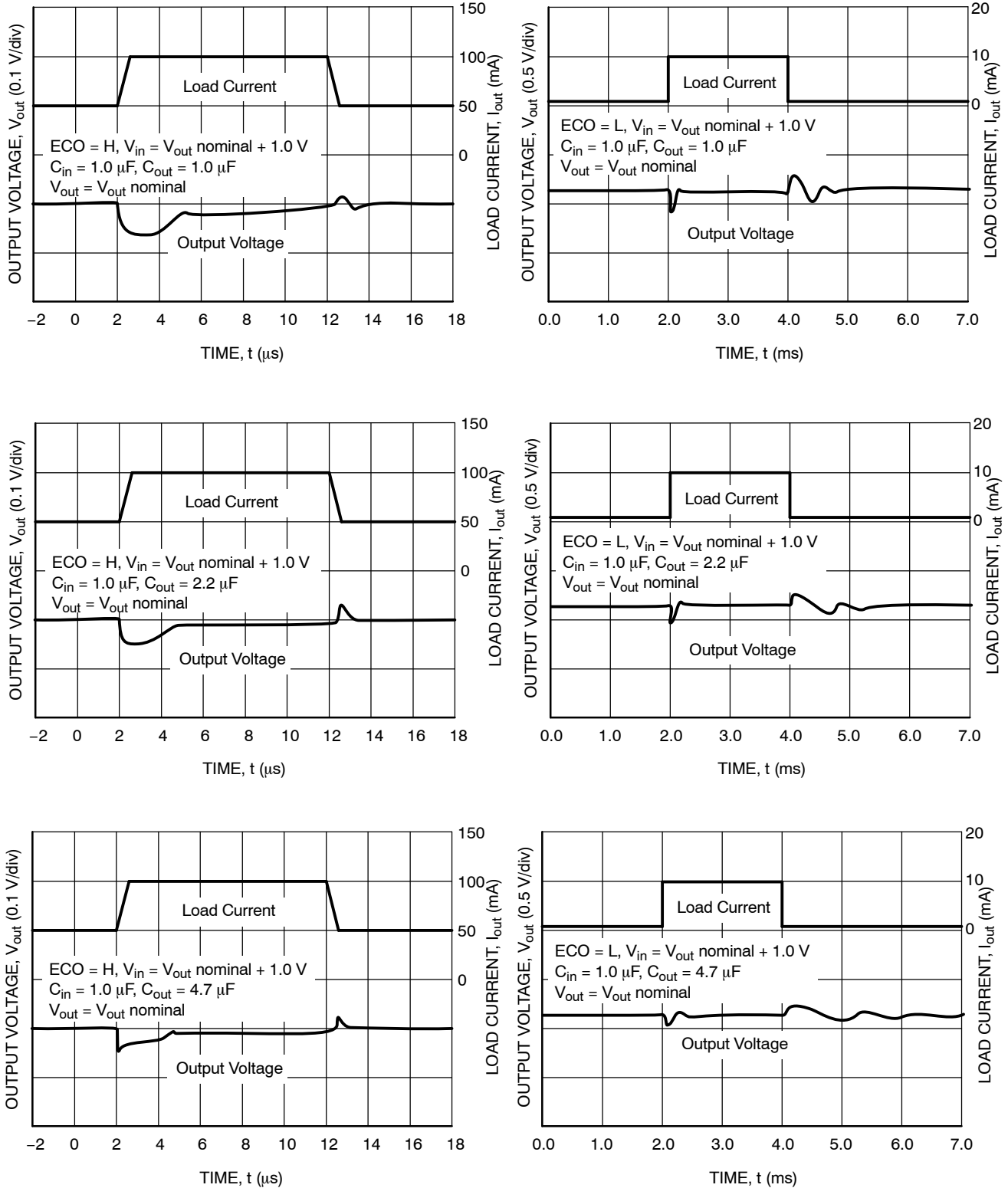

Figure 28. Load Transient Response

TYPICAL CHARACTERISTICS

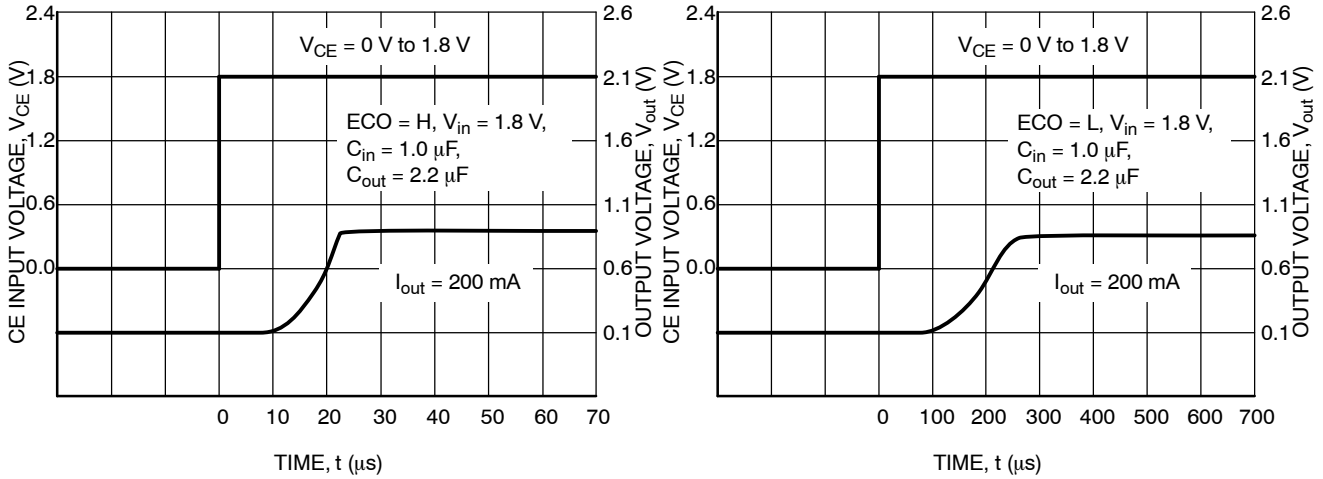

Figure 29. Turn-On/Off Speed with CE Pin ($V_{out} = 0.9$ V)

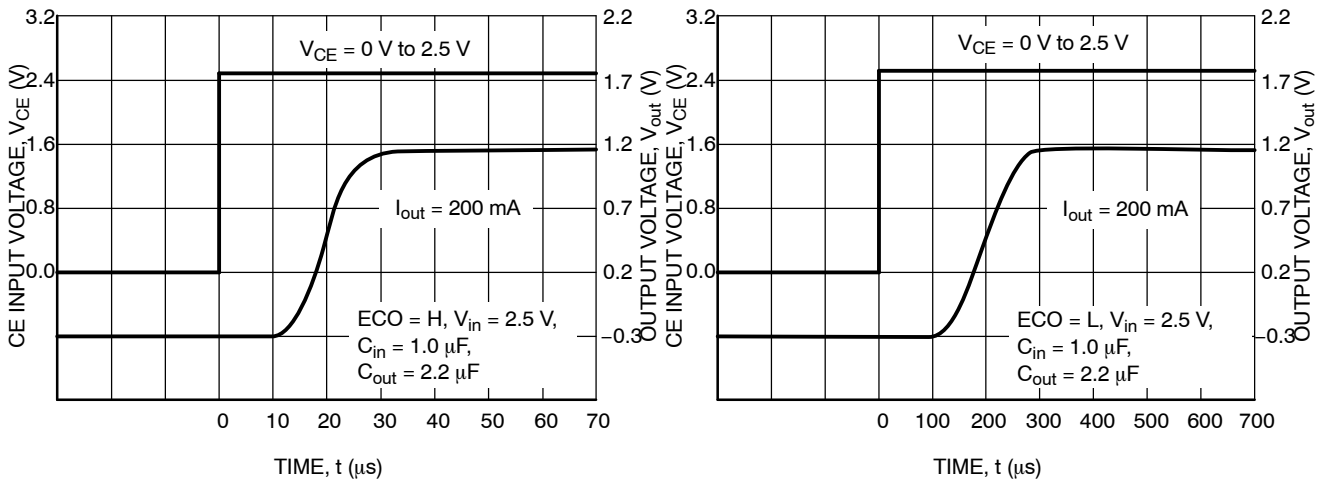

Figure 30. Turn-On/Off Speed with CE Pin ($V_{out} = 1.2$ V)

NCP584

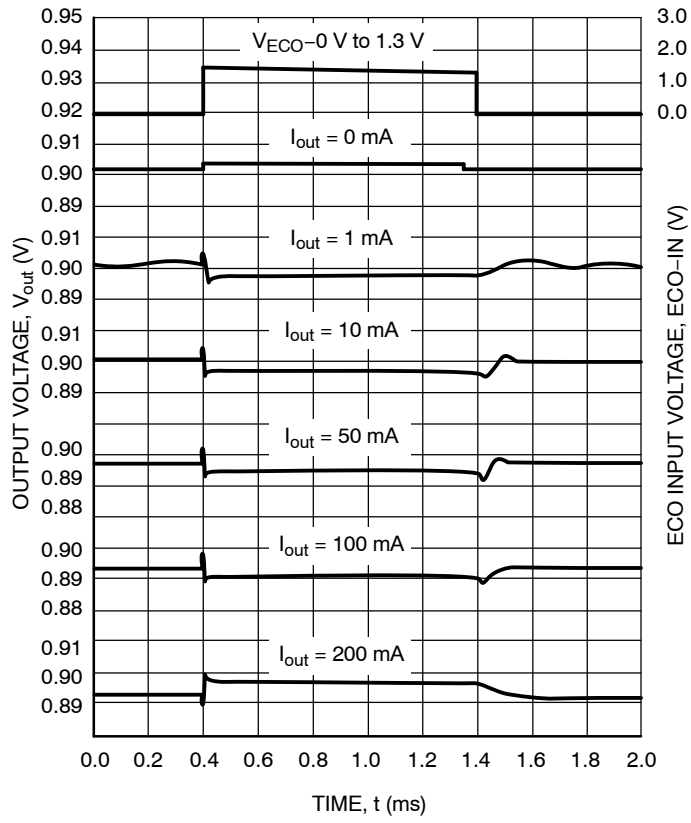

Figure 31. Output Voltage at Mode Alternative Point
($C_{in} = 1.0 \mu F$, $C_{out} = 2.2 \mu F$, 8.0 V, $V_{out} = 0.9$ V)

APPLICATION INFORMATION

Input Decoupling

A 1.0 μF tantalum capacitor is the recommended value to be connected between V_{in} and GND. For PCB layout considerations, the traces of V_{in} and GND should be sufficiently wide in order to minimize noise and prevent unstable operation.

Output Decoupling

It is recommended to use a 2.2 μF or higher tantalum capacitor on the V_{out} pin. For better performance, select a tantalum capacitor with low Equivalent Series Resistance (ESR). If you use a tantalum type capacitor with high ESR

value of this capacitor, output might be unstable. For a ceramic type capacitor it is recommended connection about 1 Ω resistor in series for the stability of output voltage. The relation between Output Current of regulator and ESR of an output capacitor is shown in Figures 32 to 34. Those charts show minimal value of ESR for stable output voltage in Fast Transient mode. The minimal ESR of an output ceramic capacitor in Low Power mode is 40 m Ω for all output voltages. For PCB layout considerations, place the output capacitor close to the output pin and keep the leads short as possible.

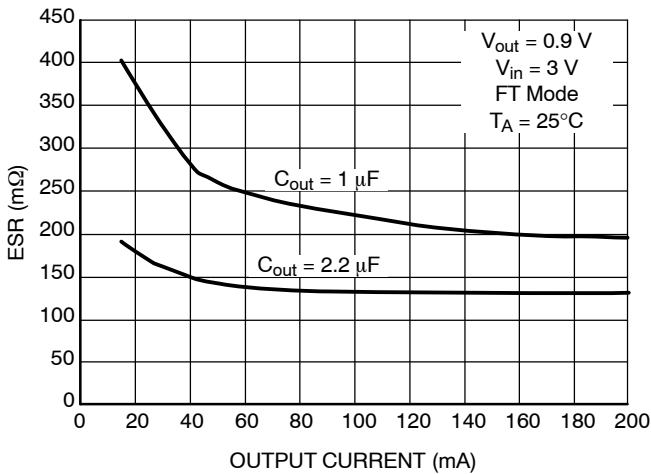

Figure 32. Minimal ESR of Output Ceramic Capacitor vs. Output Current

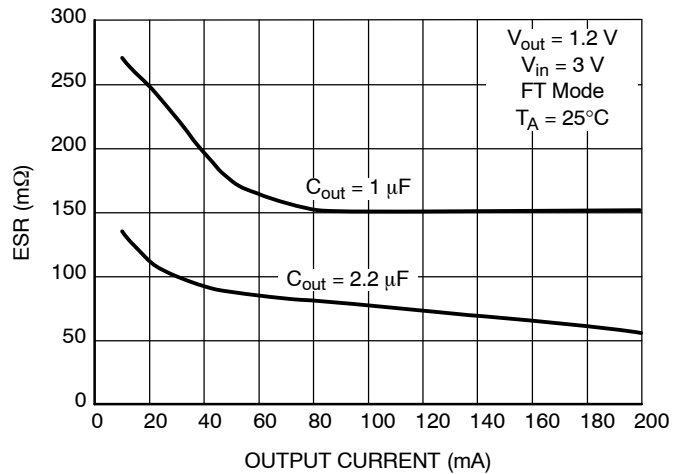

Figure 33. Minimal ESR of Output Ceramic Capacitor vs. Output Current

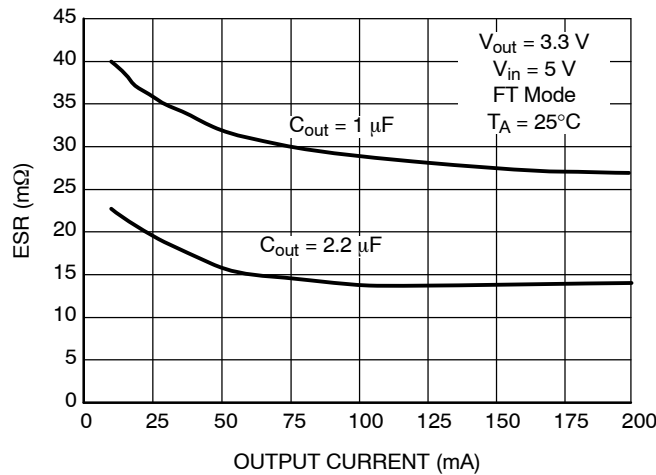

Figure 34. Minimal ESR of Output Ceramic Capacitor vs. Output Current

NCP584

ORDERING INFORMATION

Device	Output Type / Features	Nominal Output Voltage	Marking	Package	Shipping [†]
NCP584HSN09T1G	Active High, LP and FT Mode	0.9	109	SOT23-5 (Pb-Free)	3000 / Tape & Reel
NCP584HSN12T1G	Active High, LP and FT Mode	1.2	112	SOT23-5 (Pb-Free)	3000 / Tape & Reel
NCP584HSN15T1G	Active High, LP and FT Mode	1.5	115	SOT23-5 (Pb-Free)	3000 / Tape & Reel
NCP584HSN18T1G	Active High, LP and FT Mode	1.8	118	SOT23-5 (Pb-Free)	3000 / Tape & Reel
NCP584HSN25T1G	Active High, LP and FT Mode	2.5	125	SOT23-5 (Pb-Free)	3000 / Tape & Reel
NCP584HSN26T1G	Active High, LP and FT Mode	2.6	126	SOT23-5 (Pb-Free)	3000 / Tape & Reel
NCP584HSN28T1G	Active High, LP and FT Mode	2.8	128	SOT23-5 (Pb-Free)	3000 / Tape & Reel
NCP584HSN30T1G	Active High, LP and FT Mode	3.0	130	SOT23-5 (Pb-Free)	3000 / Tape & Reel
NCP584HSN31T1G	Active High, LP and FT Mode	3.1	131	SOT23-5 (Pb-Free)	3000 / Tape & Reel
NCP584HSN33T1G	Active High, LP and FT Mode	3.3	133	SOT23-5 (Pb-Free)	3000 / Tape & Reel
NCP584LSN09T1G	Active Low, LP and FT Mode	0.9	009	SOT23-5 (Pb-Free)	3000 / Tape & Reel
NCP584LSN12T1G	Active Low, LP and FT Mode	1.2	012	SOT23-5 (Pb-Free)	3000 / Tape & Reel
NCP584LSN18T1G	Active Low, LP and FT Mode	1.8	018	SOT23-5 (Pb-Free)	3000 / Tape & Reel

[†]For information on tape and reel specifications, including part orientation and tape sizes, please refer to our Tape and Reel Packaging Specification Brochure, BRD8011/D.

Other voltages are available. Consult your ON Semiconductor representative.

MECHANICAL CASE OUTLINE

PACKAGE DIMENSIONS

ON Semiconductor®



SCALE 2:1

SOT-23 5-LEAD CASE 1212-01 ISSUE A

DATE 28 JAN 2011

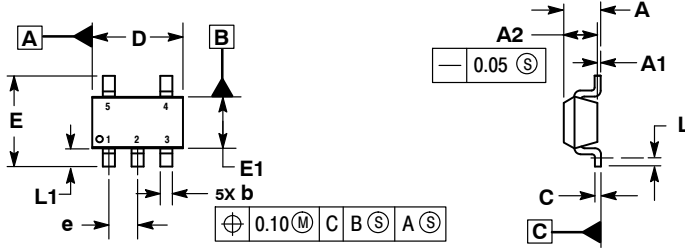

NOTES:

1. DIMENSIONING AND TOLERANCING PER ASME Y14.5M, 1994.
2. CONTROLLING DIMENSIONS: MILLIMETERS.
3. DATUM C IS THE SEATING PLANE.

MILLIMETERS		
DIM	MIN	MAX
A	---	1.45
A1	0.00	0.10
A2	1.00	1.30
b	0.30	0.50
c	0.10	0.25
D	2.70	3.10
E	2.50	3.10
E1	1.50	1.80
e	0.95 BSC	
L	0.20	---
L1	0.45	0.75

RECOMMENDED SOLDERING FOOTPRINT*

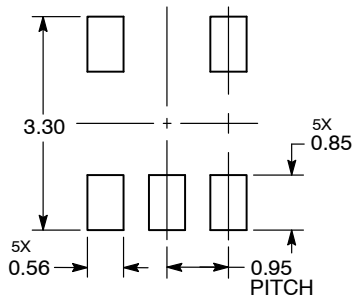

DIMENSIONS: MILLIMETERS

*For additional information on our Pb-Free strategy and soldering details, please download the ON Semiconductor Soldering and Mounting Techniques Reference Manual, SOLDERRM/D.

GENERIC MARKING DIAGRAM*

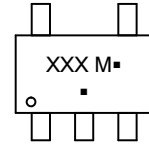

XXX = Specific Device Code

M = Date Code

▪ = Pb-Free Package

(Note: Microdot may be in either location)

*This information is generic. Please refer to device data sheet for actual part marking. Pb-Free indicator, "G" or microdot "▪", may or may not be present.

DOCUMENT NUMBER:	98ASH70518A	Electronic versions are uncontrolled except when accessed directly from the Document Repository. Printed versions are uncontrolled except when stamped "CONTROLLED COPY" in red.
DESCRIPTION:	SOT-23 5-LEAD	PAGE 1 OF 1

ON Semiconductor and are trademarks of Semiconductor Components Industries, LLC dba ON Semiconductor or its subsidiaries in the United States and/or other countries. ON Semiconductor reserves the right to make changes without further notice to any products herein. ON Semiconductor makes no warranty, representation or guarantee regarding the suitability of its products for any particular purpose, nor does ON Semiconductor assume any liability arising out of the application or use of any product or circuit, and specifically disclaims any and all liability, including without limitation special, consequential or incidental damages. ON Semiconductor does not convey any license under its patent rights nor the rights of others.

onsemi, **Onsemi**, and other names, marks, and brands are registered and/or common law trademarks of Semiconductor Components Industries, LLC dba "**onsemi**" or its affiliates and/or subsidiaries in the United States and/or other countries. **onsemi** owns the rights to a number of patents, trademarks, copyrights, trade secrets, and other intellectual property. A listing of **onsemi**'s product/patent coverage may be accessed at www.onsemi.com/site/pdf/Patent-Marking.pdf. **onsemi** reserves the right to make changes at any time to any products or information herein, without notice. The information herein is provided "as-is" and **onsemi** makes no warranty, representation or guarantee regarding the accuracy of the information, product features, availability, functionality, or suitability of its products for any particular purpose, nor does **onsemi** assume any liability arising out of the application or use of any product or circuit, and specifically disclaims any and all liability, including without limitation special, consequential or incidental damages. Buyer is responsible for its products and applications using **onsemi** products, including compliance with all laws, regulations and safety requirements or standards, regardless of any support or applications information provided by **onsemi**. "Typical" parameters which may be provided in **onsemi** data sheets and/or specifications can and do vary in different applications and actual performance may vary over time. All operating parameters, including "Typicals" must be validated for each customer application by customer's technical experts. **onsemi** does not convey any license under any of its intellectual property rights nor the rights of others. **onsemi** products are not designed, intended, or authorized for use as a critical component in life support systems or any FDA Class 3 medical devices or medical devices with a same or similar classification in a foreign jurisdiction or any devices intended for implantation in the human body. Should Buyer purchase or use **onsemi** products for any such unintended or unauthorized application, Buyer shall indemnify and hold **onsemi** and its officers, employees, subsidiaries, affiliates, and distributors harmless against all claims, costs, damages, and expenses, and reasonable attorney fees arising out of, directly or indirectly, any claim of personal injury or death associated with such unintended or unauthorized use, even if such claim alleges that **onsemi** was negligent regarding the design or manufacture of the part. **onsemi** is an Equal Opportunity/Affirmative Action Employer. This literature is subject to all applicable copyright laws and is not for resale in any manner.

PUBLICATION ORDERING INFORMATION

LITERATURE FULFILLMENT:

Email Requests to: orderlit@onsemi.com

onsemi Website: www.onsemi.com

TECHNICAL SUPPORT

North American Technical Support:

Voice Mail: 1 800-282-9855 Toll Free USA/Canada

Phone: 011 421 33 790 2910

Europe, Middle East and Africa Technical Support:

Phone: 00421 33 790 2910

For additional information, please contact your local Sales Representative

X-ON Electronics

Largest Supplier of Electrical and Electronic Components

Click to view similar products for [LDO Voltage Regulators](#) category:

Click to view products by [ON Semiconductor](#) manufacturer:

Other Similar products are found below :

[AP7363-SP-13](#) [L79M05TL-E](#) [PT7M8202B12TA5EX](#) [TCR3DF185,LM\(CT](#) [TCR3DF24,LM\(CT](#) [TCR3DF285,LM\(CT](#) [TCR3DF31,LM\(CT](#)
[TCR3DF45,LM\(CT](#) [MP2013GQ-33-Z](#) [059985X](#) [NCP4687DH15T1G](#) [701326R](#) [TCR2EN28,LF\(S](#) [NCV8170AXV250T2G](#)
[TCR3DF27,LM\(CT](#) [TCR3DF19,LM\(CT](#) [TCR3DF125,LM\(CT](#) [TCR2EN18,LF\(S](#) [AP2112R5A-3.3TRG1](#) [AP7315-25W5-7](#)
[IFX30081LDVGRNXUMA1](#) [AP2113KTR-G1](#) [AP2111H-1.2TRG1](#) [ZLDO1117QK50TC](#) [AZ1117IH-1.8TRG1](#) [AZ1117ID-ADJTRG1](#)
[TCR3DG12,LF](#) [MIC5514-3.3YMT-T5](#) [MIC5512-1.2YMT-T5](#) [MIC5317-2.8YM5-T5](#) [SCD7912BTG](#) [NCP154MX180270TAG](#) [SCD33269T-](#)
[5.0G](#) [NCV8170BMX330TCG](#) [NCV8170AMX120TCG](#) [NCP706ABMX300TAG](#) [NCP153MX330180TCG](#) [NCP114BMX075TCG](#)
[MC33269T-3.5G](#) [CAT6243-ADJCMT5T](#) [TCR3DG33,LF](#) [AP2127N-1.0TRG1](#) [TCR4DG35,LF](#) [LT1117CST-3.3](#) [LT1117CST-5](#)
[TAR5S15U\(TE85L,F\)](#) [TAR5S18U\(TE85L,F\)](#) [TCR3UG19A,LF](#) [TCR4DG105,LF](#) [NCV8170AMX360TCG](#)