

# NCP585

## Tri-Mode 300 mA CMOS LDO Regulator with Enable

The NCP585 series of low dropout regulators are designed for portable battery powered applications which require precise output voltage accuracy, low quiescent current, and high ripple rejection. These devices feature an enable function which lowers current consumption significantly and are offered in the SOT23-5 and the HSON-6 packages, in fixed output voltages between 0.8 V and 3.3 V.

This series of devices have three modes. Chip Enable (CE mode), Fast Transient Mode (FT mode), and Low Power Mode (LP mode). Both the FT and LP mode are utilized via the ECO pin.

### Features

- Tri-mode Operation
- Low Dropout Voltage:
  - Typ 550 mV at 300 mA, Output Voltage = 0.9 V
  - Typ 480 mV at 300 mA, Output Voltage = 1.0 V
  - Typ 310 mV at 300 mA, Output Voltage = 1.5 V
- Excellent Line Regulation of 0.01%/V (0.05%/V LP Mode)
- Excellent Load Regulation of 15 mV (40 mV FT Mode)
- High Output Voltage Accuracy of  $\pm 2\%$  ( $\pm 3\%$  LP mode)
- Ultra-Low Iq Current of:
  - 3.5  $\mu\text{A}$  (LP mode, Output Voltage < 1.6 V)
  - 80  $\mu\text{A}$  (FT mode, Output Voltage < 1.8 V)
  - 60  $\mu\text{A}$  (FT mode, Output Voltage = 1.8 V)
- Very Low Shutdown Current of 0.1  $\mu\text{A}$
- Excellent Power Supply Rejection Ratio of 70 dB at f = 1.0 kHz
- Low Temperature Drift Coefficient on the Output Voltage of  $\pm 100$  ppm/ $^{\circ}\text{C}$
- Fold Back Protection Circuit
- Input Voltage up to 6.5 V
- These are Pb-Free Devices

### Typical Applications

- Portable Equipment
- Hand-Held Instrumentation
- Camcorders and Cameras



ON Semiconductor®

<http://onsemi.com>

### MARKING DIAGRAMS



SOT23-5  
SN SUFFIX  
CASE 1212

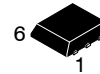
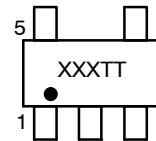

HSON-6  
SAN SUFFIX  
CASE 506AE

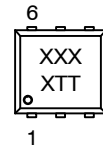

XXX = Specific Device Code  
TT = Traceability Information

### ORDERING INFORMATION

See detailed ordering and shipping information in the package dimensions section on page 11 of this data sheet.

\*Additional voltage options may be available between 0.8 V and 3.3 V in 100 mV steps.

# NCP585

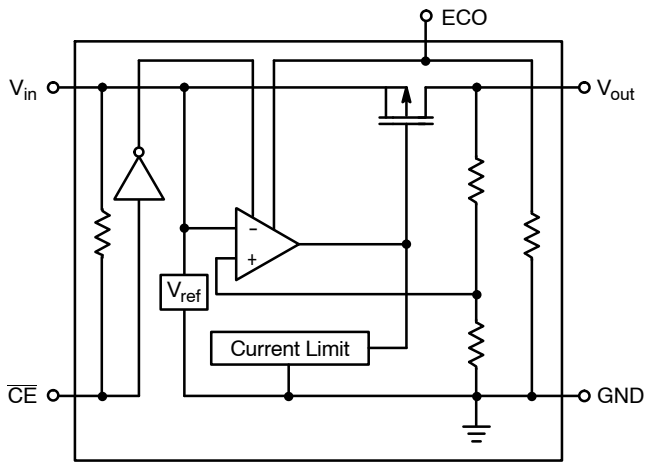

Figure 1. Simplified Block Diagram for Active Low

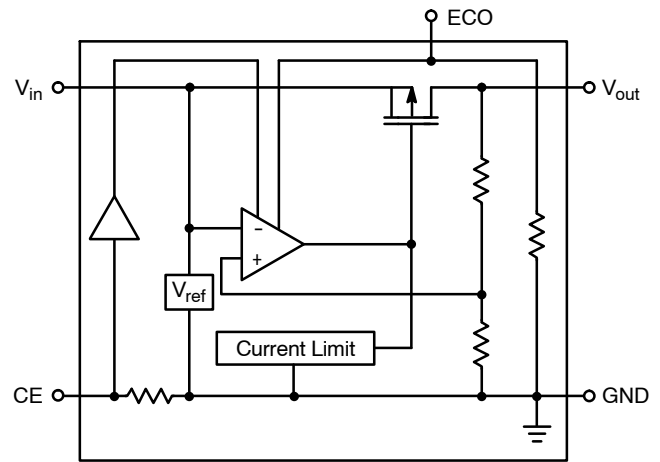

Figure 2. Simplified Block Diagram for Active High

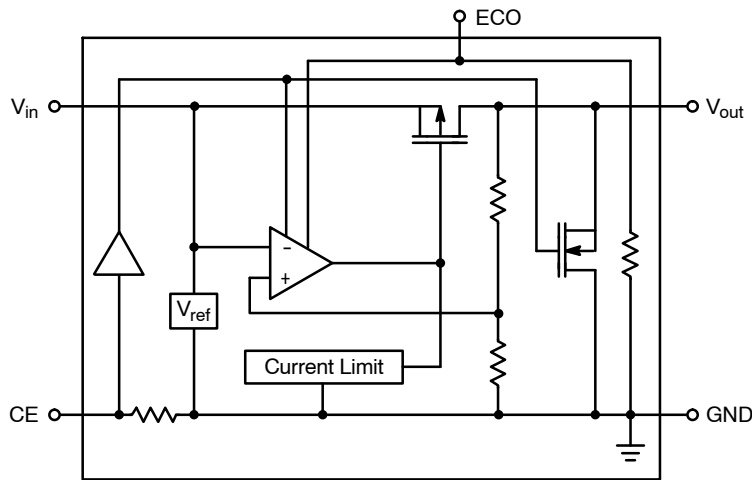

Figure 3. Simplified Block Diagram for Active High with Auto Discharge

## PIN FUNCTION DESCRIPTION

HSO-6	SOT23-5	Pin Name	Description
1	1	$V_{in}$	Power supply input voltage.
2	-	NC	No Connect.
3	5	$V_{out}$	Regulated output voltage.
4	4	ECO	Mode alternative pin. ( $V_{ECO} = V_{in}$ for FT mode; $V_{ECO} = GND$ for LP mode)
5	2	GND	Power supply ground.
6	3	$\overline{CE}$ or CE	Chip enable pin.

# NCP585

## MAXIMUM RATINGS

Rating	Symbol	Value	Unit
Input Voltage	$V_{in}$	6.5	V
Input Voltage ( $\overline{CE}$ or CE Pin)	$V_{CE}$	-0.3 to 6.5	V
Input Voltage (ECO Pin)	$V_{ECO}$	-0.3 to 6.5	V
Output Voltage	$V_{out}$	-0.3 to $V_{in} + 0.3$	V
Output Current	$I_{out}$	350	mA
Power Dissipation	$P_D$	250 400	mW
SOT23-5 HSO-6			
ESD Capability, Human Body Model, C = 100 pF, R = 1.5 k $\Omega$	$ESD_{HBM}$	2000	V
ESD Capability, Machine Model, C = 200 pF, R = 0 $\Omega$	$ESD_{MM}$	150	V
Operating Ambient Temperature Range	$T_A$	-40 to +85	$^{\circ}C$
Maximum Junction Temperature	$T_{J(max)}$	125	$^{\circ}C$
Storage Temperature Range	$T_{stg}$	-55 to +150	$^{\circ}C$

Stresses exceeding Maximum Ratings may damage the device. Maximum Ratings are stress ratings only. Functional operation above the Recommended Operating Conditions is not implied. Extended exposure to stresses above the Recommended Operating Conditions may affect device reliability.

## ELECTRICAL CHARACTERISTICS ( $V_{in} = V_{out} + 1.0$ V, $T_A = 25^{\circ}C$ , unless otherwise noted.)

Characteristic	Symbol	Min	Typ	Max	Unit		
Input Voltage	$V_{in}$	1.4	-	6.0	V		
Output Voltage ( $1.0 \mu A \leq I_{out} \leq 30$ mA) $V_{ECO} = V_{in}$ $V_{ECO} = GND$	$V_{out}$	$V_{out} \times 0.980$ $V_{out} \times 0.970$	- -	$V_{out} \times 1.020$ $V_{out} \times 1.030$	V		
Line Regulation ( $I_{out} = 30$ mA, $V_{out} + 0.5$ V $\leq V_{in} \leq 6.0$ V) FT Mode $V_{ECO} = V_{in}$ LP Mode $V_{ECO} = GND$	$Reg_{line}$	- -	0.01 0.05	0.15 0.20	%/V		
Load Regulation FT Mode ( $1.0$ mA $\leq I_{out} \leq 300$ mA), $V_{ECO} = V_{in}$ LP Mode ( $1.0$ mA $\leq I_{out} \leq 100$ mA), $V_{ECO} = GND$	$Reg_{load}$	- -	40 15	70 30	mV		
Dropout Voltage ( $I_{out} = 300$ mA) $V_{out} = 0.9$ V $1.0$ V $\leq V_{out} \leq 1.25$ V $1.5$ V $\leq V_{out} \leq 2.5$ V $2.8$ V $\leq V_{out} \leq 3.3$ V	$V_{DO}$	- - - -	ECO = H 0.55 0.48 0.31 0.23	ECO = L 0.59 0.51 0.32 0.24	ECO = H 0.78 0.70 0.45 0.35	ECO = L 0.80 0.75 0.48 0.375	V
Quiescent Current ( $I_{out} = 0$ mA) FT Mode, $V_{ECO} = V_{in}$ $V_{out} < 1.8$ V $V_{out} \geq 1.8$ V LP Mode, $V_{ECO} = GND$ $V_{out} < 1.6$ V $V_{out} \geq 1.8$ V	$I_q$	- - - -	80 60 3.5 4.5	111 90 8.0 9.0	$\mu A$		
Output Current ( $V_{in} - V_{out} = 1.0$ V)	$I_{out}$	300	-	-	mA		
Shutdown Current ( $V_{CE} = V_{in}$ )	$I_{SD}$	-	0.1	1.0	$\mu A$		
Output Short Circuit Current ( $V_{out} = 0$ V)	$I_{lim}$	-	50	-	mA		
Enable Input Threshold Voltage - High - Low	$V_{th_{enh}}$ $V_{th_{enl}}$	1.0 0.0	- -	$V_{in}$ 0.3	V		
Output Noise Voltage (10 Hz - 100 kHz)	$V_n$	-	30	-	$\mu V_{rms}$		
N-Channel On Resistance for Auto Discharge	$R_{Low}$	-	60	-	$\Omega$		
Ripple Rejection ( $I_{out} = 50$ mA, $V_{out} = 0.9$ V, $V_{in} - V_{out} = 1.0$ V) $f = 120$ Hz $f = 1.0$ kHz $f = 10$ kHz	RR	- - -	75 70 65	- - -	dB		
Output Voltage Temperature Coefficient ( $I_{out} = 30$ mA, $-40^{\circ}C \leq T_A \leq 85^{\circ}C$ )	$\Delta V_{out}/\Delta T$	-	$\pm 100$	-	ppm/ $^{\circ}C$		

TYPICAL CHARACTERISTICS

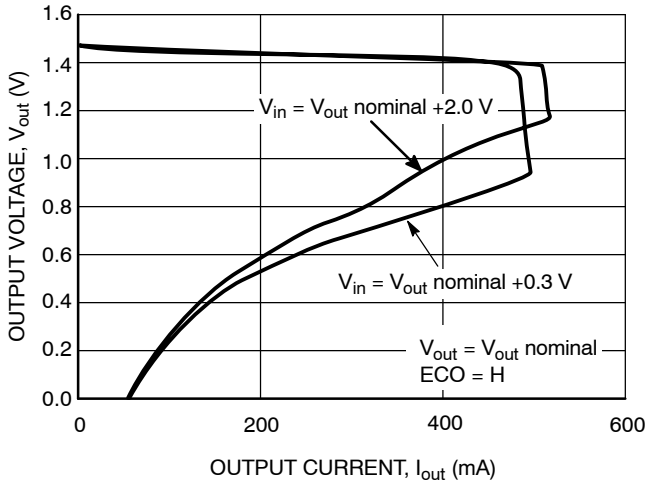

Figure 4. Output Voltage vs. Output Current

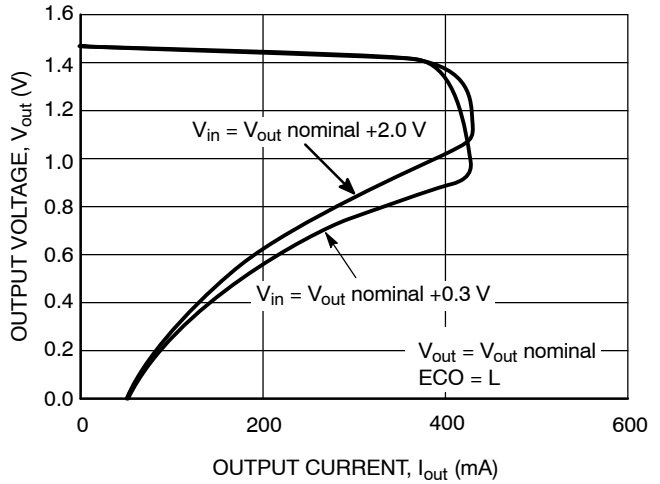

Figure 5. Output Voltage vs. Output Current

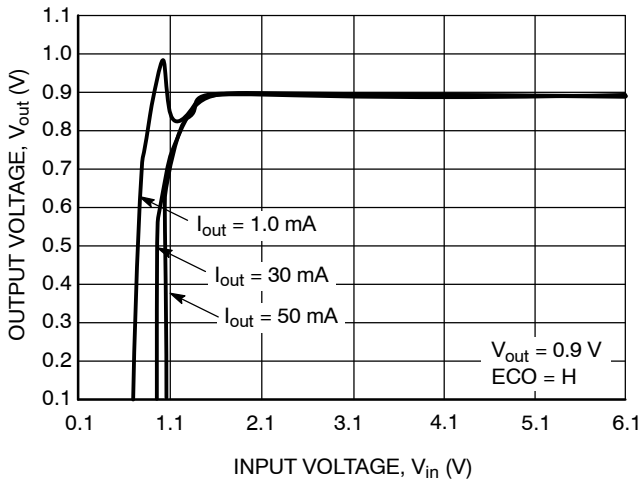

Figure 6. Output Voltage vs. Input Voltage

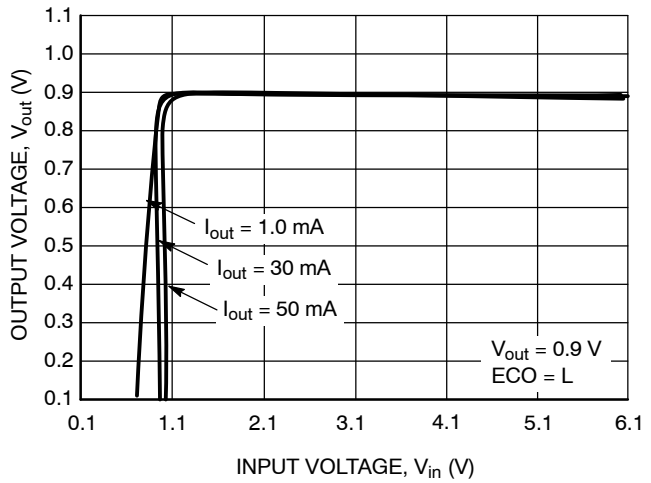

Figure 7. Output Voltage vs. Input Voltage

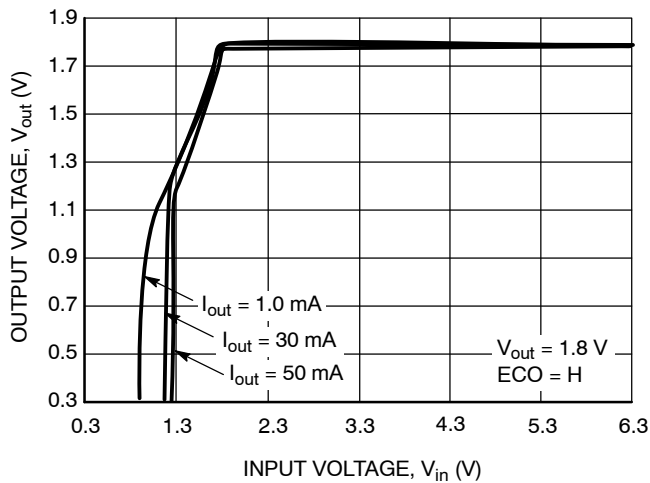

Figure 8. Output Voltage vs. Input Voltage

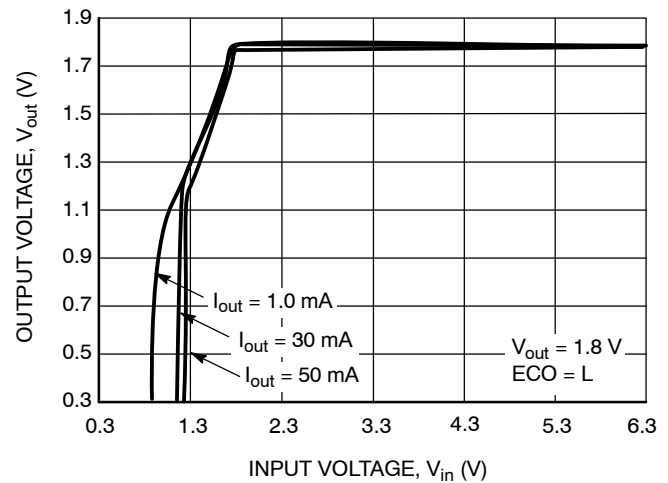

Figure 9. Output Voltage vs. Input Voltage

TYPICAL CHARACTERISTICS

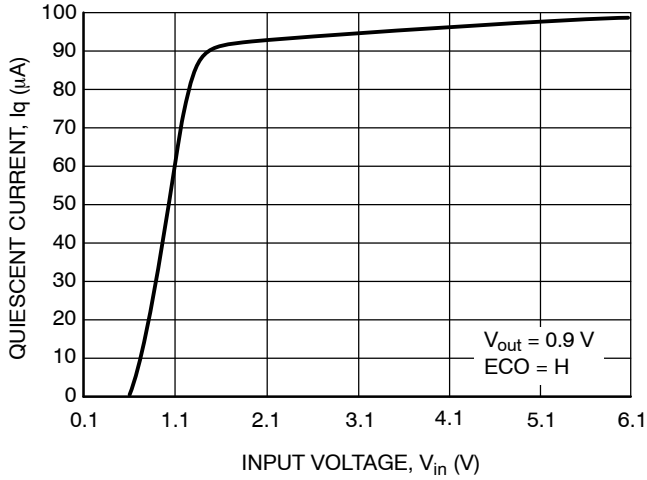

Figure 10. Quiescent Current vs. Input Voltage

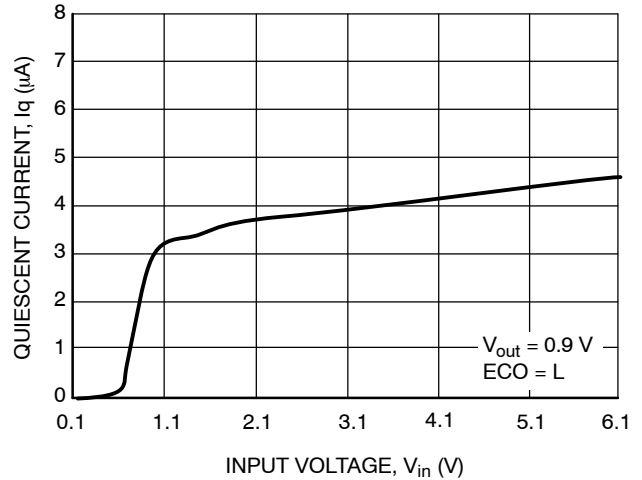

Figure 11. Quiescent Current vs. Input Voltage

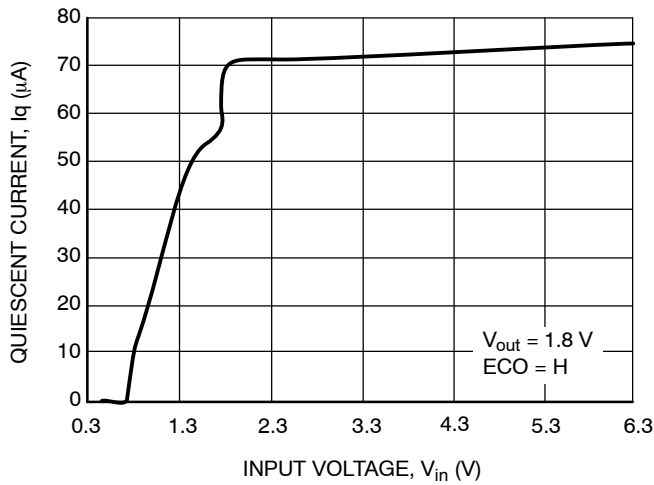

Figure 12. Quiescent Current vs. Input Voltage

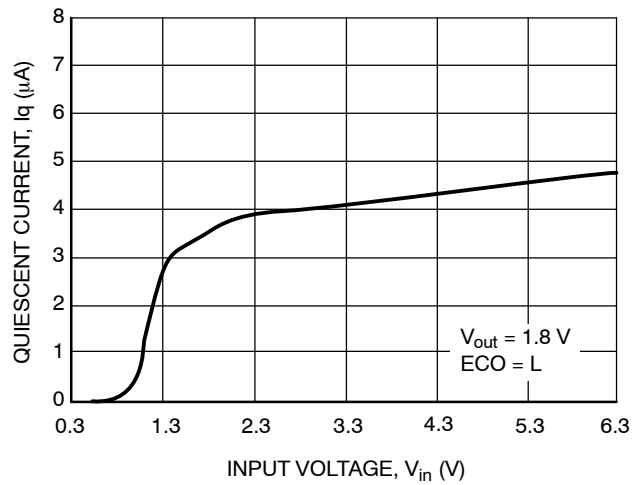

Figure 13. Quiescent Current vs. Input Voltage

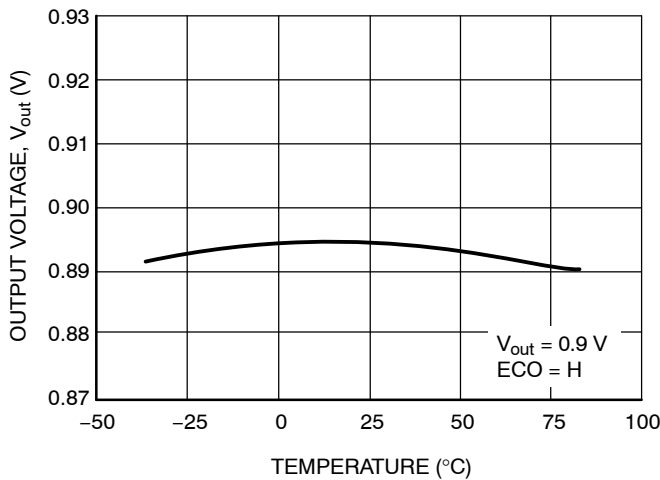

Figure 14. Output Voltage vs. Temperature

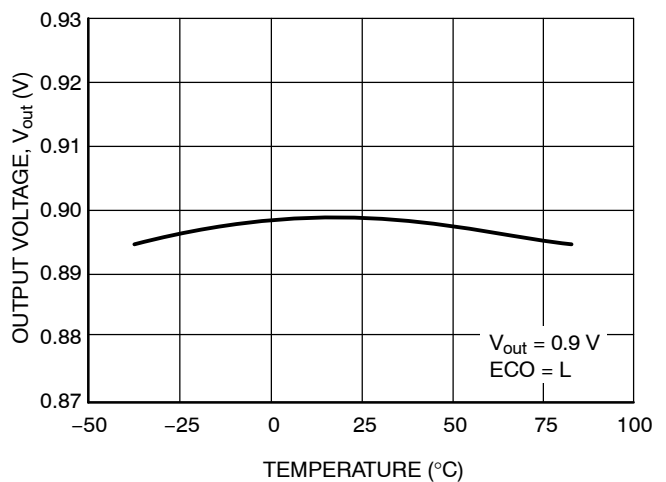

Figure 15. Output Voltage vs. Temperature

TYPICAL CHARACTERISTICS

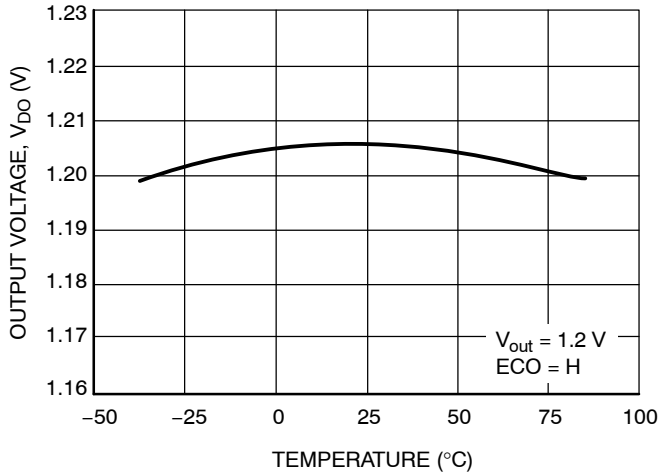

Figure 16. Output Voltage vs. Temperature

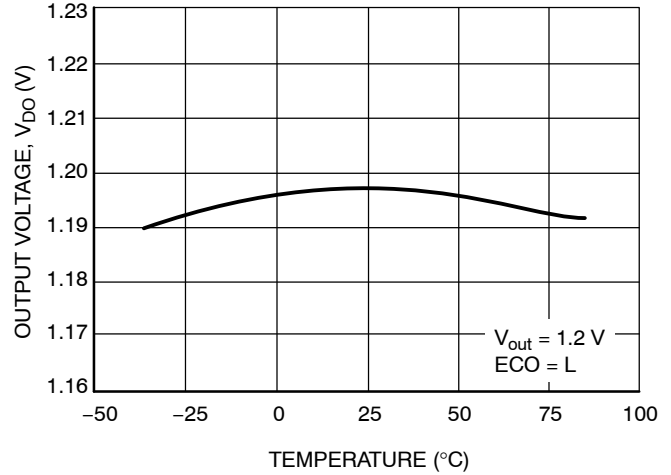

Figure 17. Output Voltage vs. Temperature

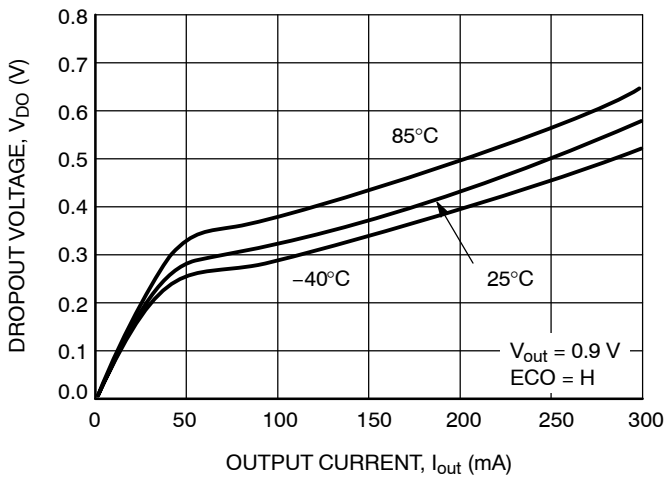

Figure 18. Dropout Voltage vs. Output Current

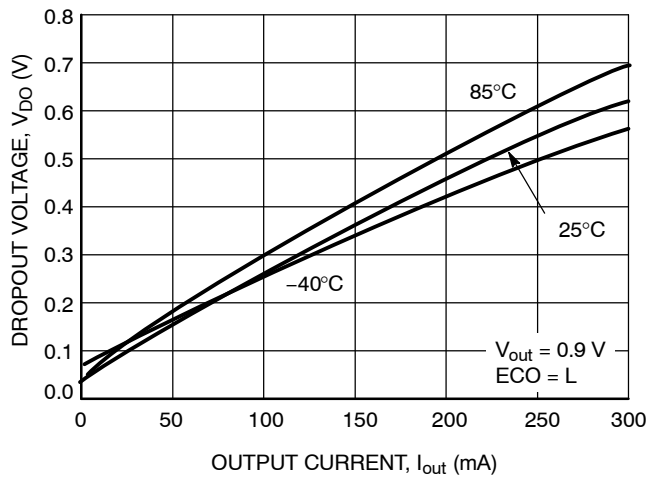

Figure 19. Dropout Voltage vs. Output Current

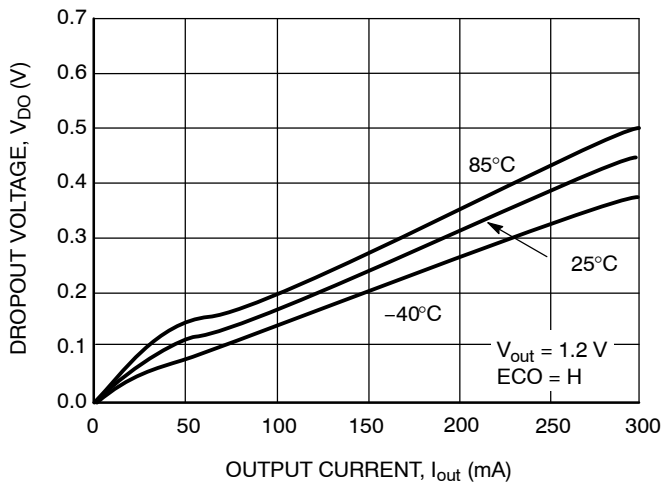

Figure 20. Dropout Voltage vs. Output Current

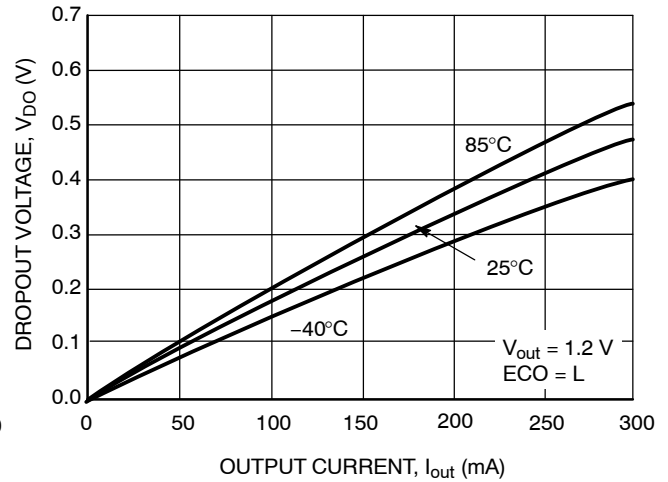

Figure 21. Dropout Voltage vs. Output Current

TYPICAL CHARACTERISTICS

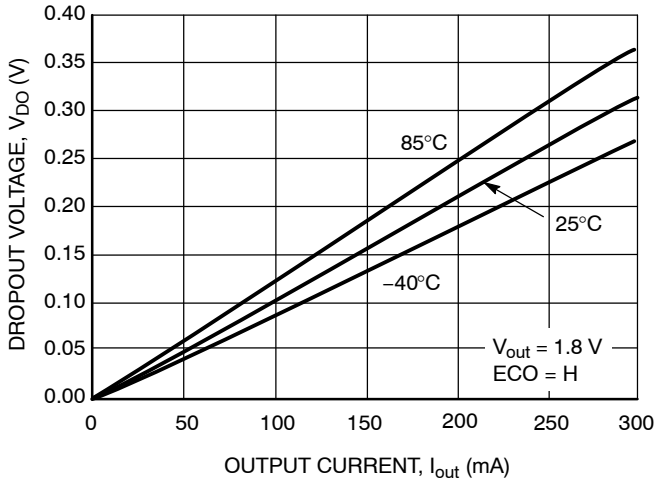

Figure 22. Dropout Voltage vs. Output Current

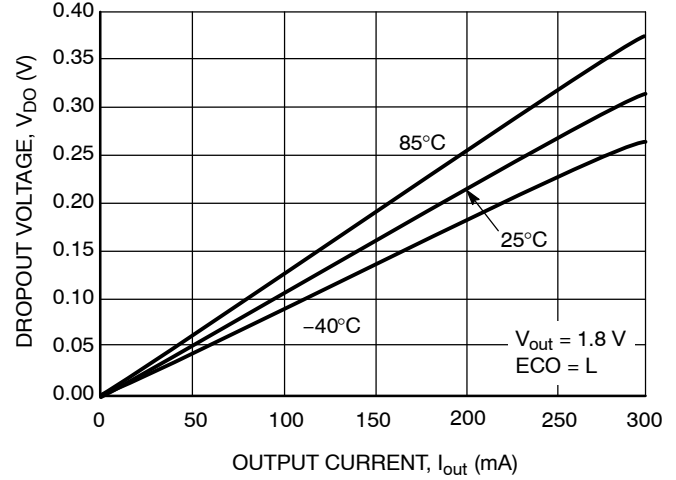

Figure 23. Dropout Voltage vs. Output Current

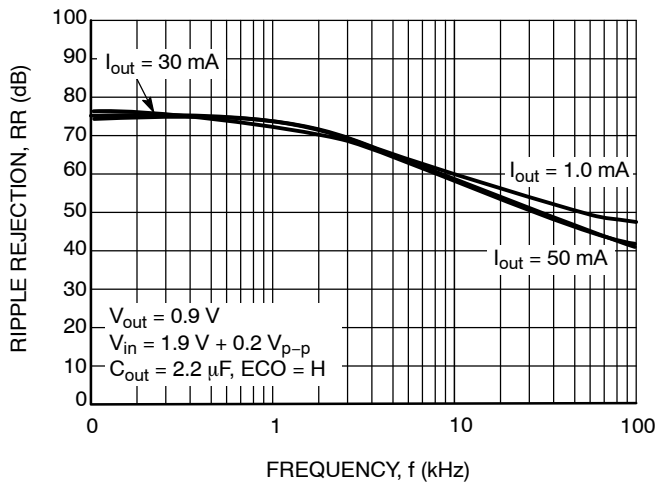

Figure 24. Ripple Rejection vs. Frequency

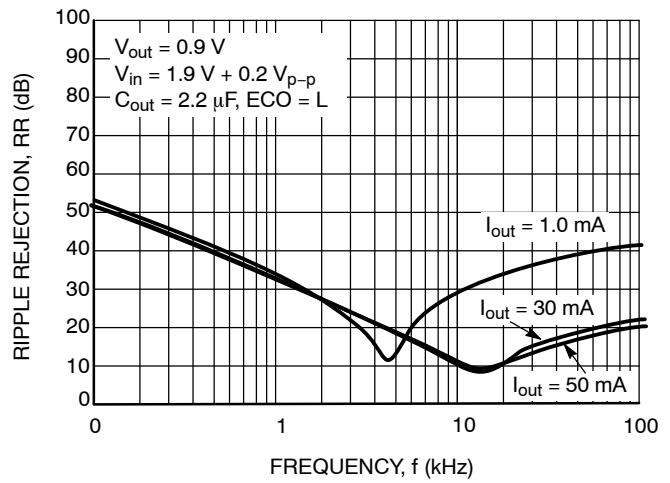

Figure 25. Ripple Rejection vs. Frequency

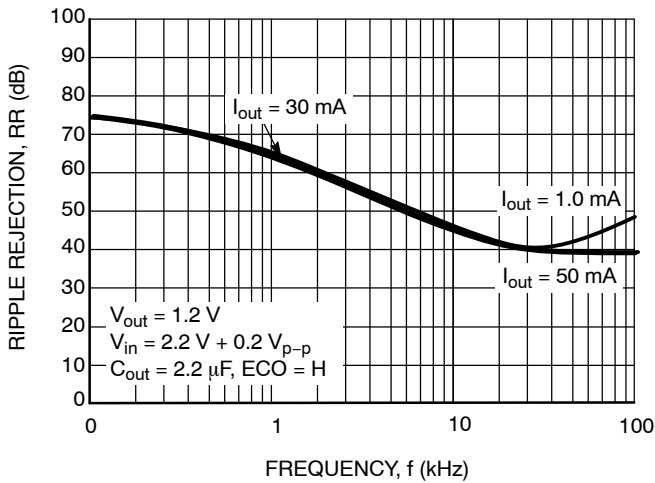

Figure 26. Ripple Rejection vs. Frequency

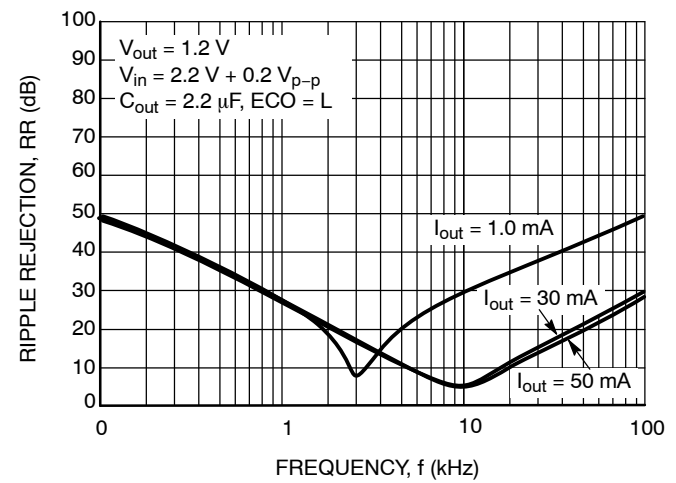

Figure 27. Ripple Rejection vs. Frequency

TYPICAL CHARACTERISTICS

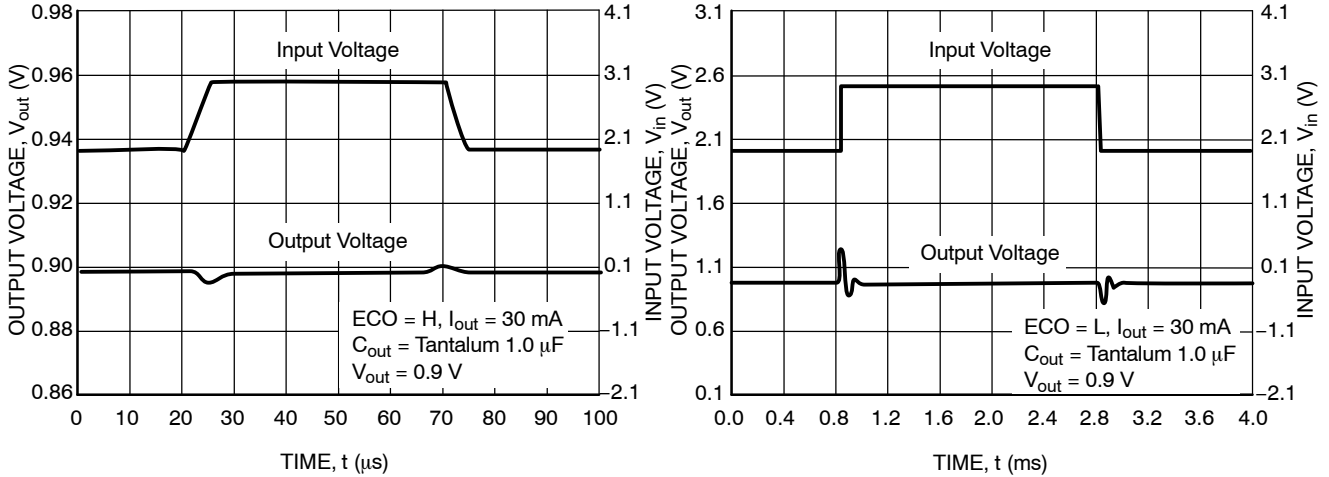

Figure 28. Input Transient Response

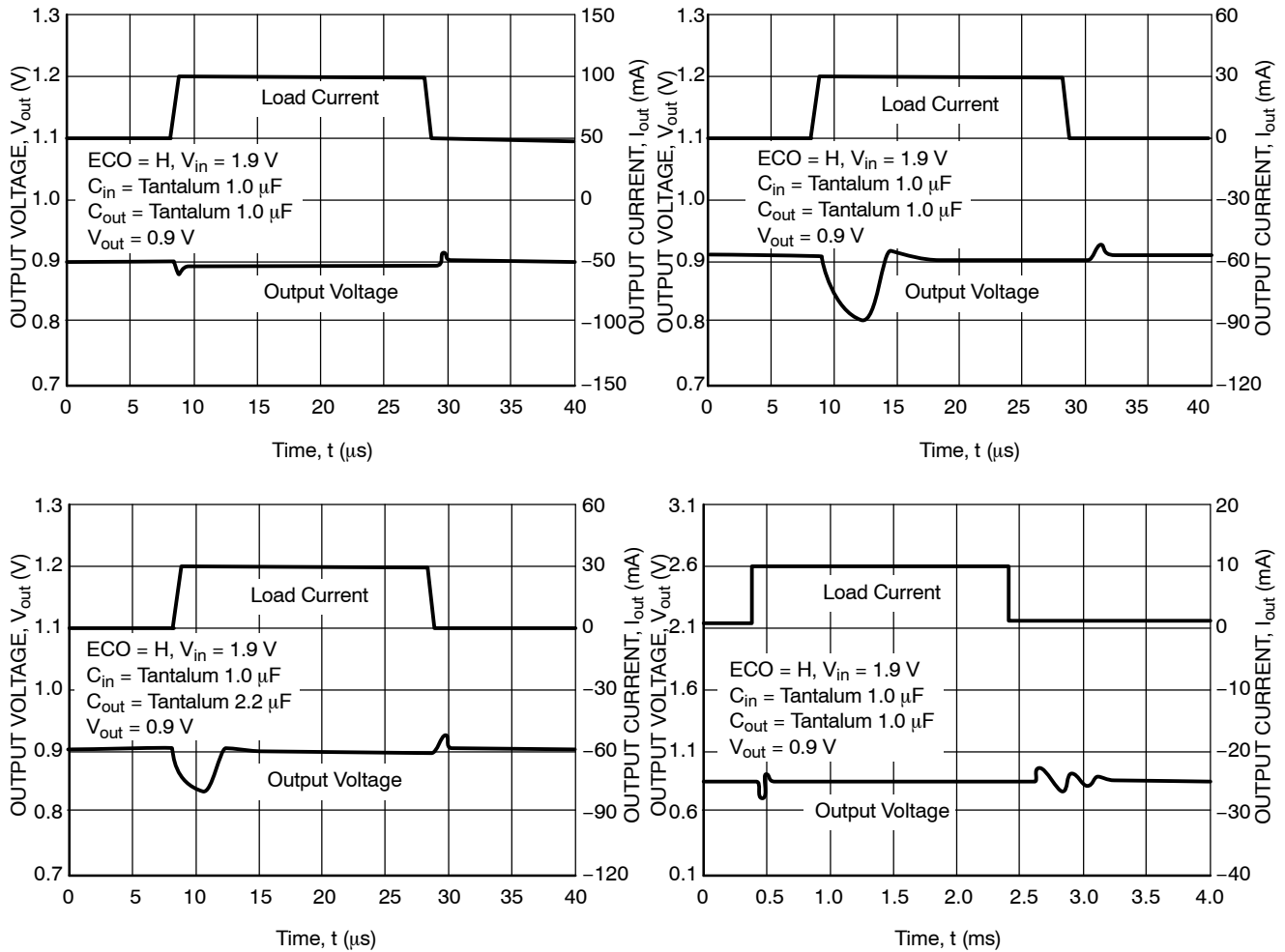

Figure 29. Load Transient Response



# NCP585

## TYPICAL CHARACTERISTICS

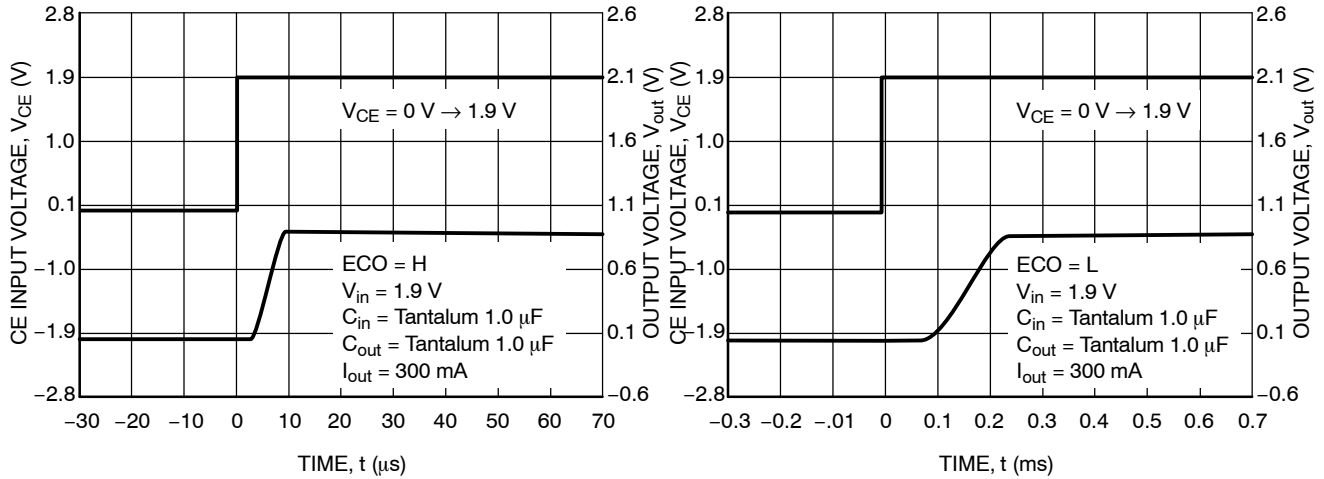

Figure 30. Turn-On Speed with CE Pin,  $V_{out} = 0.8$  V

$V_{in} = 1.9$  V,  $C_{in} = \text{Tantalum } 1.0 \mu F$ ,  $C_{out} = \text{Tantalum } 1.0 \mu F$ ,  $V_{out} = 0.9$  V

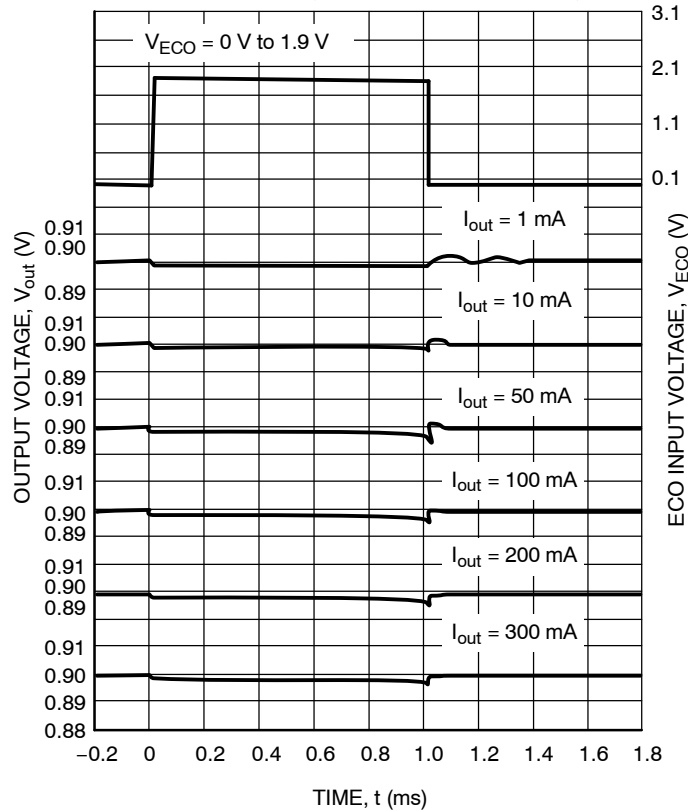

Figure 31. Output Voltage at Mode Alternative Point

TYPICAL CHARACTERISTICS

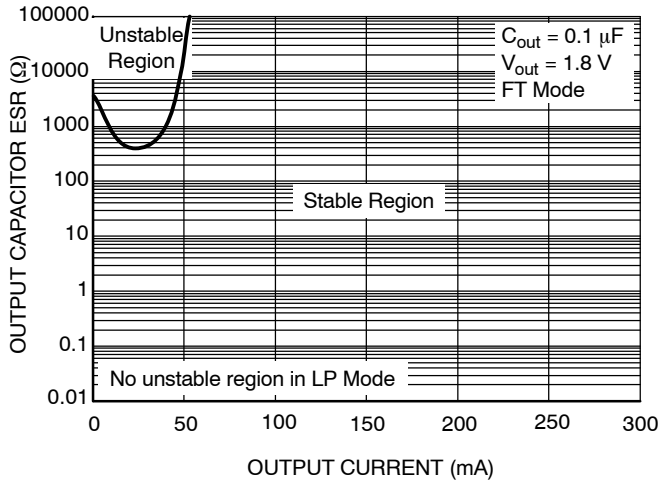

Figure 32. Output Stability, Output Capacitor ESR vs. Output Load Current (0.1  $\mu F$ )

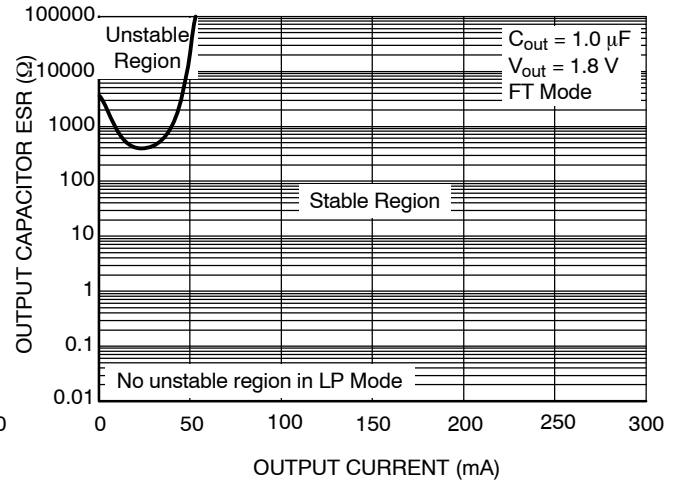

Figure 33. Output Stability, Output Capacitor ESR vs. Output Load Current (1.0  $\mu F$ )

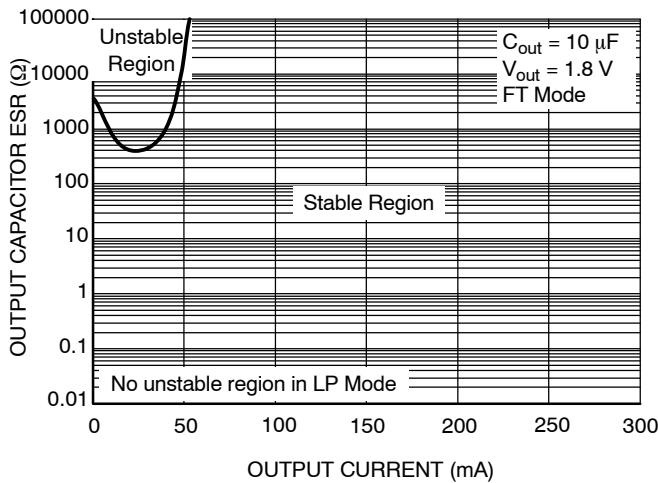

Figure 34. Output Stability, Output Capacitor ESR vs. Output Load Current (10  $\mu F$ )

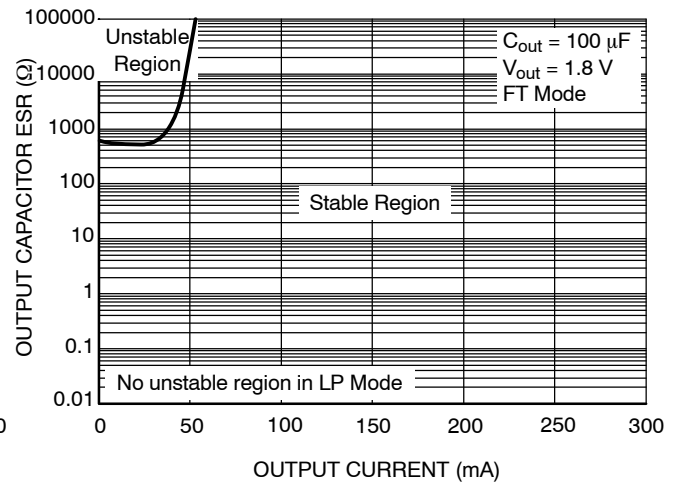

Figure 35. Output Stability, Output Capacitor ESR vs. Output Load Current (100  $\mu F$ )

APPLICATION INFORMATION

Input Decoupling

A 1.0  $\mu F$  ceramic capacitor is the recommended value to be connected between  $V_{in}$  and GND. For PCB layout considerations, the traces on  $V_{in}$  and GND should be sufficiently wide in order to minimize noise and prevent unstable operation.

Output Decoupling

It is best to use a 1.0  $\mu F$  capacitor value on the  $V_{out}$  pin. For better performance, select a capacitor with low Equivalent Series Resistance (ESR). For PCB layout considerations, place the output capacitor close to the output pin and keep the leads short as possible.

# NCP585

## ORDERING INFORMATION

Device	Output Type / Features	Nominal Output Voltage	Marking	Package	Shipping <sup>†</sup>
NCP585DSAN09T1G	Active High w/Auto Discharge, LP and FT Mode	0.9	B09D	HSO-6 (Pb-Free)	3000 Tape & Reel
NCP585DSAN12T1G	Active High w/Auto Discharge, LP and FT Mode	1.2	B12D	HSO-6 (Pb-Free)	3000 Tape & Reel
NCP585DSAN18T1G	Active High w/Auto Discharge, LP and FT Mode	1.8	B18D	HSO-6 (Pb-Free)	3000 Tape & Reel
NCP585DSN09T1G	Active High w/Auto Discharge, LP and FT Mode	0.9	R09	SOT23-5 (Pb-Free)	3000 Tape & Reel
NCP585DSN12T1G	Active High w/Auto Discharge, LP and FT Mode	1.2	R12	SOT23-5 (Pb-Free)	3000 Tape & Reel
NCP585DSN125T1G	Active High w/Auto Discharge, LP and FT Mode	1.25	R01	SOT23-5 (Pb-Free)	3000 Tape & Reel
NCP585DSN15T1G	Active High w/Auto Discharge, LP and FT Mode	1.5	R15	SOT23-5 (Pb-Free)	3000 Tape & Reel
NCP585DSN18T1G	Active High w/Auto Discharge, LP and FT Mode	1.8	R18	SOT23-5 (Pb-Free)	3000 Tape & Reel
NCP585DSN25T1G	Active High w/Auto Discharge, LP and FT Mode	2.5	R25	SOT23-5 (Pb-Free)	3000 Tape & Reel
NCP585DSN28T1G	Active High w/Auto Discharge, LP and FT Mode	2.8	R28	SOT23-5 (Pb-Free)	3000 Tape & Reel
NCP585DSN30T1G	Active High w/Auto Discharge, LP and FT Mode	3.0	R30	SOT23-5 (Pb-Free)	3000 Tape & Reel
NCP585DSN33T1G	Active High w/Auto Discharge, LP and FT Mode	3.3	R33	SOT23-5 (Pb-Free)	3000 Tape & Reel
NCP585HSAN09T1G	Active High, LP and FT Mode	0.9	B09B	HSO-6 (Pb-Free)	3000 Tape & Reel
NCP585HSAN12T1G	Active High, LP and FT Mode	1.2	B12B	HSO-6 (Pb-Free)	3000 Tape & Reel
NCP585HSAN18T1G	Active High, LP and FT Mode	1.8	B18B	HSO-6 (Pb-Free)	3000 Tape & Reel
NCP585HSN09T1G	Active High, LP and FT Mode	0.9	Q09	SOT23-5 (Pb-Free)	3000 Tape & Reel
NCP585HSN10T1G	Active High, LP and FT Mode	1.0	Q10	SOT23-5 (Pb-Free)	3000 Tape & Reel
NCP585HSN12T1G	Active High, LP and FT Mode	1.2	Q12	SOT23-5 (Pb-Free)	3000 Tape & Reel
NCP585HSN18T1G	Active High, LP and FT Mode	1.8	Q18	SOT23-5 (Pb-Free)	3000 Tape & Reel
NCP585HSN30T1G	Active High, LP and FT Mode	3.0	Q30	SOT23-5 (Pb-Free)	3000 Tape & Reel
NCP585LSAN09T1G	Active Low, LP and FT Mode	0.9	B09A	HSO-6 (Pb-Free)	3000 Tape & Reel
NCP585LSAN12T1G	Active Low, LP and FT Mode	1.2	B12A	HSO-6 (Pb-Free)	3000 Tape & Reel
NCP585LSAN18T1G	Active Low, LP and FT Mode	1.8	B18A	HSO-6 (Pb-Free)	3000 Tape & Reel
NCP585LSN09T1G	Active Low, LP and FT Mode	0.9	P09	SOT23-5 (Pb-Free)	3000 Tape & Reel
NCP585LSN12T1G	Active Low, LP and FT Mode	1.2	P12	SOT23-5 (Pb-Free)	3000 Tape & Reel
NCP585LSN18T1G	Active Low, LP and FT Mode	1.8	P18	SOT23-5 (Pb-Free)	3000 Tape & Reel

<sup>†</sup>For information on tape and reel specifications, including part orientation and tape sizes, please refer to our Tape and Reel Packaging Specification Brochure, BRD8011/D.

Other voltages are available. Consult your ON Semiconductor representative.

# MECHANICAL CASE OUTLINE

## PACKAGE DIMENSIONS

ON Semiconductor®



SCALE 2:1

### SOT-23 5-LEAD CASE 1212-01 ISSUE A

DATE 28 JAN 2011

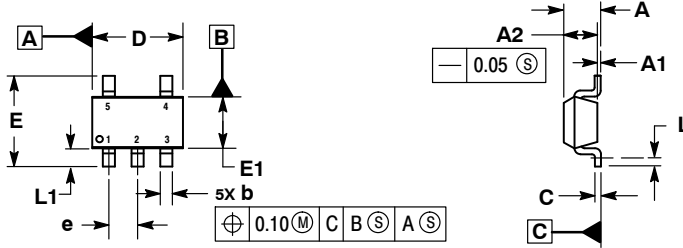

NOTES:

1. DIMENSIONING AND TOLERANCING PER ASME Y14.5M, 1994.
2. CONTROLLING DIMENSIONS: MILLIMETERS.
3. DATUM C IS THE SEATING PLANE.

MILLIMETERS		
DIM	MIN	MAX
A	---	1.45
A1	0.00	0.10
A2	1.00	1.30
b	0.30	0.50
c	0.10	0.25
D	2.70	3.10
E	2.50	3.10
E1	1.50	1.80
e	0.95 BSC	
L	0.20	---
L1	0.45	0.75

### RECOMMENDED SOLDERING FOOTPRINT\*

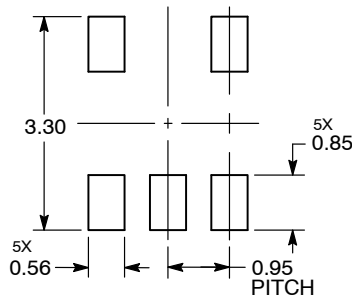

DIMENSIONS: MILLIMETERS

\*For additional information on our Pb-Free strategy and soldering details, please download the ON Semiconductor Soldering and Mounting Techniques Reference Manual, SOLDERRM/D.

### GENERIC MARKING DIAGRAM\*

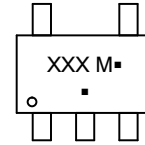

XXX = Specific Device Code

M = Date Code

▪ = Pb-Free Package

(Note: Microdot may be in either location)

\*This information is generic. Please refer to device data sheet for actual part marking. Pb-Free indicator, "G" or microdot "▪", may or may not be present.

<b>DOCUMENT NUMBER:</b>	<b>98ASH70518A</b>	Electronic versions are uncontrolled except when accessed directly from the Document Repository. Printed versions are uncontrolled except when stamped "CONTROLLED COPY" in red.
<b>DESCRIPTION:</b>	<b>SOT-23 5-LEAD</b>	<b>PAGE 1 OF 1</b>

ON Semiconductor and are trademarks of Semiconductor Components Industries, LLC dba ON Semiconductor or its subsidiaries in the United States and/or other countries. ON Semiconductor reserves the right to make changes without further notice to any products herein. ON Semiconductor makes no warranty, representation or guarantee regarding the suitability of its products for any particular purpose, nor does ON Semiconductor assume any liability arising out of the application or use of any product or circuit, and specifically disclaims any and all liability, including without limitation special, consequential or incidental damages. ON Semiconductor does not convey any license under its patent rights nor the rights of others.

# MECHANICAL CASE OUTLINE

## PACKAGE DIMENSIONS

ON Semiconductor®



SCALE 2:1

**HSO**N-6  
CASE 506AE-01  
ISSUE A

DATE 26 JAN 2005

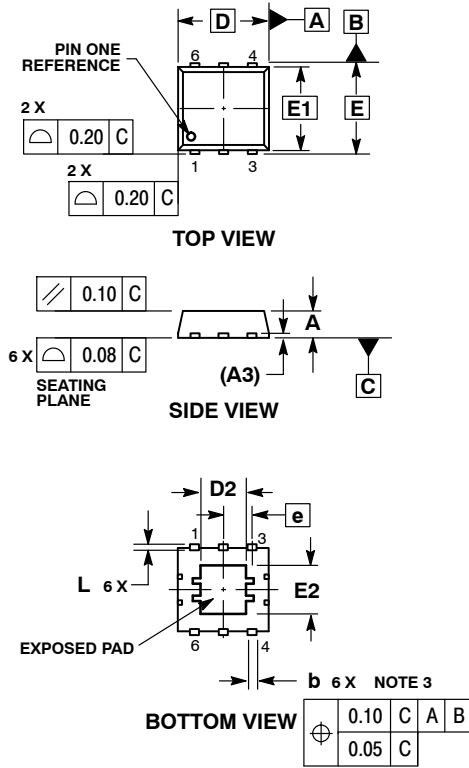

**NOTES:**

1. DIMENSIONING AND TOLERANCING PER ASME Y14.5M, 1994.
2. CONTROLLING DIMENSION: MILLIMETERS.
3. DIMENSION b APPLIES TO PLATED TERMINAL AND IS MEASURED BETWEEN 0.10 AND 0.15 MM FROM TERMINAL.
4. COPLANARITY APPLIES TO THE EXPOSED PAD AS WELL AS THE TERMINALS.

DIM	MILLIMETERS	
	MIN	MAX
A	0.70	0.90
A3	0.15 REF	
b	0.20	0.40
D	2.90 BSC	
D2	1.40	1.60
E	3.00 BSC	
E1	2.80 BSC	
E2	1.50	1.70
e	0.95 BSC	
L	0.15	0.25

**GENERIC MARKING DIAGRAM\***

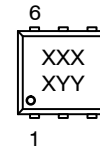

XXXX = Specific Device Code  
YY = Wafer Lot

\*This information is generic. Please refer to device data sheet for actual part marking. Pb-Free indicator, "G" or microdot "▪", may or may not be present.

<b>DOCUMENT NUMBER:</b>	<b>98AON19447D</b>	Electronic versions are uncontrolled except when accessed directly from the Document Repository. Printed versions are uncontrolled except when stamped "CONTROLLED COPY" in red.
<b>DESCRIPTION:</b>	<b>HSO</b> N-6, 2.9 X 3.0 MM, 0.95 MM PITCH	<b>PAGE 1 OF 1</b>

ON Semiconductor and ON are trademarks of Semiconductor Components Industries, LLC dba ON Semiconductor or its subsidiaries in the United States and/or other countries. ON Semiconductor reserves the right to make changes without further notice to any products herein. ON Semiconductor makes no warranty, representation or guarantee regarding the suitability of its products for any particular purpose, nor does ON Semiconductor assume any liability arising out of the application or use of any product or circuit, and specifically disclaims any and all liability, including without limitation special, consequential or incidental damages. ON Semiconductor does not convey any license under its patent rights nor the rights of others.

**onsemi**, **Onsemi**, and other names, marks, and brands are registered and/or common law trademarks of Semiconductor Components Industries, LLC dba "**onsemi**" or its affiliates and/or subsidiaries in the United States and/or other countries. **onsemi** owns the rights to a number of patents, trademarks, copyrights, trade secrets, and other intellectual property. A listing of **onsemi**'s product/patent coverage may be accessed at [www.onsemi.com/site/pdf/Patent-Marking.pdf](http://www.onsemi.com/site/pdf/Patent-Marking.pdf). **onsemi** reserves the right to make changes at any time to any products or information herein, without notice. The information herein is provided "as-is" and **onsemi** makes no warranty, representation or guarantee regarding the accuracy of the information, product features, availability, functionality, or suitability of its products for any particular purpose, nor does **onsemi** assume any liability arising out of the application or use of any product or circuit, and specifically disclaims any and all liability, including without limitation special, consequential or incidental damages. Buyer is responsible for its products and applications using **onsemi** products, including compliance with all laws, regulations and safety requirements or standards, regardless of any support or applications information provided by **onsemi**. "Typical" parameters which may be provided in **onsemi** data sheets and/or specifications can and do vary in different applications and actual performance may vary over time. All operating parameters, including "Typicals" must be validated for each customer application by customer's technical experts. **onsemi** does not convey any license under any of its intellectual property rights nor the rights of others. **onsemi** products are not designed, intended, or authorized for use as a critical component in life support systems or any FDA Class 3 medical devices or medical devices with a same or similar classification in a foreign jurisdiction or any devices intended for implantation in the human body. Should Buyer purchase or use **onsemi** products for any such unintended or unauthorized application, Buyer shall indemnify and hold **onsemi** and its officers, employees, subsidiaries, affiliates, and distributors harmless against all claims, costs, damages, and expenses, and reasonable attorney fees arising out of, directly or indirectly, any claim of personal injury or death associated with such unintended or unauthorized use, even if such claim alleges that **onsemi** was negligent regarding the design or manufacture of the part. **onsemi** is an Equal Opportunity/Affirmative Action Employer. This literature is subject to all applicable copyright laws and is not for resale in any manner.

## PUBLICATION ORDERING INFORMATION

### LITERATURE FULFILLMENT:

Email Requests to: [orderlit@onsemi.com](mailto:orderlit@onsemi.com)

**onsemi Website:** [www.onsemi.com](http://www.onsemi.com)

### TECHNICAL SUPPORT

**North American Technical Support:**

Voice Mail: 1 800-282-9855 Toll Free USA/Canada

Phone: 011 421 33 790 2910

**Europe, Middle East and Africa Technical Support:**

Phone: 00421 33 790 2910

For additional information, please contact your local Sales Representative

## X-ON Electronics

Largest Supplier of Electrical and Electronic Components

*Click to view similar products for [LDO Voltage Regulators](#) category:*

*Click to view products by [ON Semiconductor](#) manufacturer:*

Other Similar products are found below :

[AP7363-SP-13](#) [L79M05TL-E](#) [PT7M8202B12TA5EX](#) [TCR3DF185,LM\(CT](#) [TCR3DF24,LM\(CT](#) [TCR3DF285,LM\(CT](#) [TCR3DF31,LM\(CT](#)  
[TCR3DF45,LM\(CT](#) [MP2013GQ-33-Z](#) [059985X](#) [NCP4687DH15T1G](#) [701326R](#) [TCR2EN28,LF\(S](#) [NCV8170AXV250T2G](#)  
[TCR3DF27,LM\(CT](#) [TCR3DF19,LM\(CT](#) [TCR3DF125,LM\(CT](#) [TCR2EN18,LF\(S](#) [AP2112R5A-3.3TRG1](#) [AP7315-25W5-7](#)  
[IFX30081LDVGRNXUMA1](#) [NCV47411PAAJR2G](#) [AP2113KTR-G1](#) [AP2111H-1.2TRG1](#) [ZLDO1117QK50TC](#) [AZ1117IH-1.8TRG1](#)  
[AZ1117ID-ADJTRG1](#) [TCR3DG12,LF](#) [MIC5514-3.3YMT-T5](#) [MIC5512-1.2YMT-T5](#) [MIC5317-2.8YM5-T5](#) [SCD7912BTG](#)  
[NCP154MX180270TAG](#) [SCD33269T-5.0G](#) [NCV8170BMX330TCG](#) [NCV8170AMX120TCG](#) [NCP706ABMX300TAG](#)  
[NCP153MX330180TCG](#) [NCP114BMX075TCG](#) [MC33269T-3.5G](#) [CAT6243-ADJCMT5T](#) [TCR3DG33,LF](#) [AP2127N-1.0TRG1](#)  
[TCR4DG35,LF](#) [LT1117CST-3.3](#) [LT1117CST-5](#) [TAR5S15U\(TE85L,F\)](#) [TAR5S18U\(TE85L,F\)](#) [TCR3UG19A,LF](#) [TCR4DG105,LF](#)