

LDO Regulator - Low I_{GND}, CMOS with/without Enable and with Enhanced 500 mA



ON Semiconductor®

<http://onsemi.com>

NCP605, NCP606

The NCP605/NCP606 provide in excess of 500 mA of output current at fixed voltage options or an adjustable output voltage from 5.0 V down to 1.25 V. These devices are designed for space constrained and portable battery powered applications and offer additional features such as high PSRR, low noise operation, short circuit and thermal protection. The devices are designed to be used with low cost ceramic capacitors and are packaged in the DFN6 3x3.3. NCP605 is designed without enable pin, NCP606 is designed with enable pin.

Features

- Output Voltage Options:
Adjustable, 1.5 V, 1.8 V, 2.5 V, 2.8 V, 3.0 V, 3.3 V, 5.0 V
- Adjustable Output by External Resistors from 5.0 V down to 1.25 V
- Current Limit 675 mA
- Low I_{GND} (Independent of Load)
- ±1.5% Output Voltage Tolerance Over All Operating Conditions (Adjustable)
- ±2% Output Voltage Tolerance Over All Operating Conditions (Fixed)
- NCP605 Fixed is Direct Replacement LP8345
- Typical Noise Voltage of 50 μV_{rms} without a Bypass Capacitor
- Enhanced ESD Ratings: 4 kV Human Body Mode (HBM)
200 V Machine Model (MM)
- These are Pb-Free Devices

Typical Applications

- Hard Disk Drivers
- Notebook Computers
- Battery Power Electronics
- Portable Instrumentation

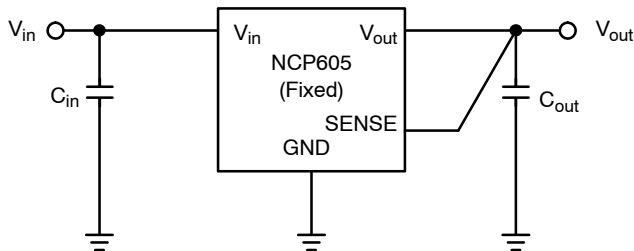
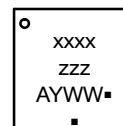

Figure 1. NCP605 Typical Application Circuit for Fixed Version (1.5 V, 1.8 V, 2.5 V, 2.8 V, 3.0 V, 3.3 V, 5.0 V)



DFN6, 3x3.3
MN SUFFIX
CASE 506AX

MARKING DIAGRAM



- xxxx = P605 or P606
- zzz = ADJ, 150, 180, 250, 280, 300, 330, 500
- A = Assembly Location
- Y = Year
- WW = Work Week
- = Pb-Free Package

(*Note: Microdot may be in either location)

NCP605 PIN CONNECTIONS

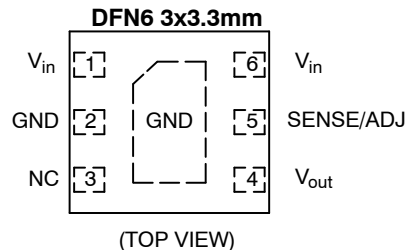

NCP606 PIN CONNECTIONS

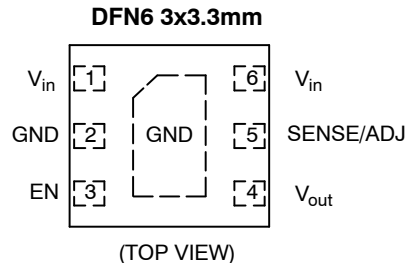

ORDERING INFORMATION

See detailed ordering and shipping information in the package dimensions section on page 12 of this data sheet.

NCP605, NCP606

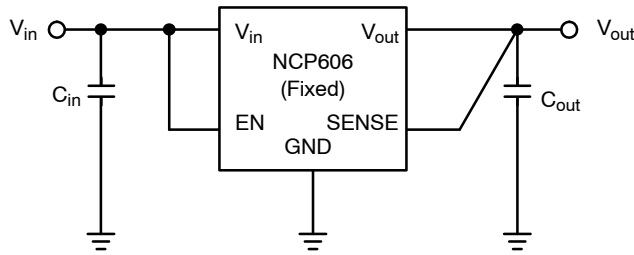

Figure 2. NCP606 Typical Application Circuit for Fixed Version (1.5 V, 1.8 V, 2.5 V, 2.8 V, 3.0 V, 3.3 V, 5.0 V)

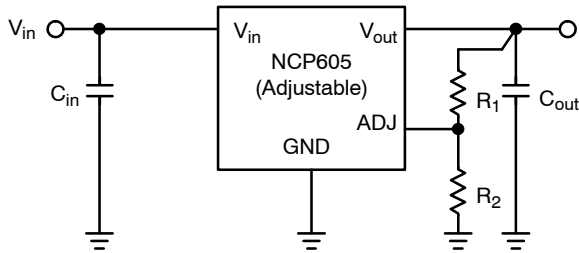

Figure 3. NCP605 Typical Application Circuit for Adjustable Version ($1.25\text{ V} < V_{out} \leq 5.0\text{ V}$)

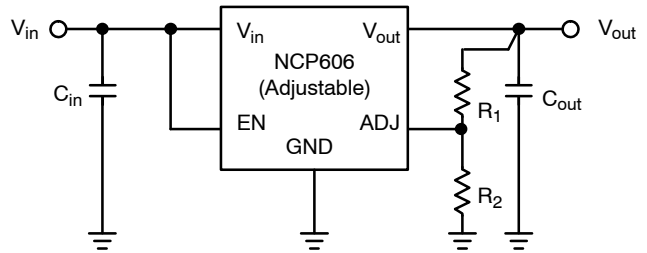

Figure 4. NCP606 Typical Application Circuit for Adjustable Version ($1.25\text{ V} < V_{out} \leq 5.0\text{ V}$)

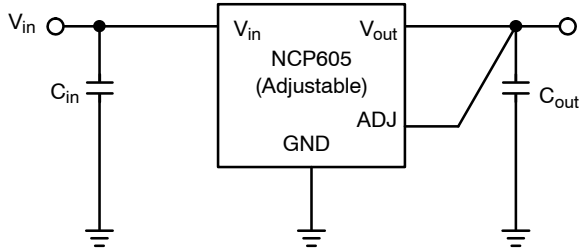

Figure 5. NCP605 Typical Application Circuit for Adjustable Version ($V_{out} = 1.25\text{ V}$)

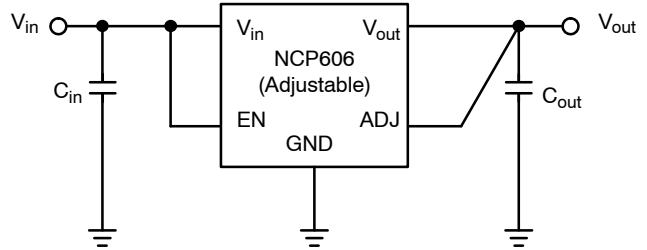

Figure 6. NCP606 Typical Application Circuit for Adjustable Version ($V_{out} = 1.25\text{ V}$)

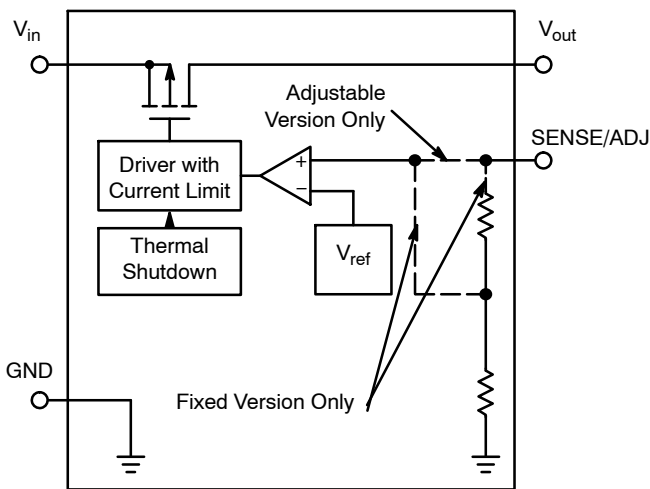

Figure 7. NCP605 Simplified Block Diagram

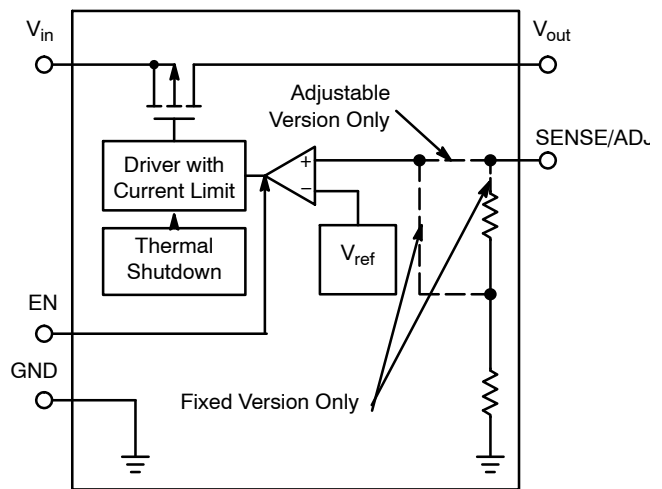

Figure 8. NCP606 Simplified Block Diagram

NCP605, NCP606

PIN FUNCTION DESCRIPTION

| Pin No. | Pin Name | Description |
|---------|------------------|---------------------------------------------------------------------------------------------------------------------------------------------------------------|
| 1 | V _{in} | Positive Power Supply Input* |
| 2 | GND | Power Supply Ground |
| 3 | NC/EN | NCP605: This Pin is Not Connected NCP606: This Pin is Enable Input, Active HIGH |
| 4 | V _{out} | Regulated Output Voltage |
| 5 | SENSE/ADJ | Output Voltage Sense Input Fixed Version: Connect Directly to Output Capacitor Adjustable Version: Connect to Middle Point of External Resistor Divider |
| 6 | V _{in} | Positive Power Supply Input* |
| EPAD | GND | Exposed Pad is Connected to Ground |

*Pins 1 and 6 must be connected together externally for output current full range operation

ABSOLUTE MAXIMUM RATINGS

| Rating | Symbol | Value | Unit |
|---------------------------------------------|-----------------------------------|-------------|------|
| Input Voltage Range (Note 1) | V _{in} | -0.3 to 6.5 | V |
| Chip Enable Voltage Range (NCP606 only) | V _{EN} | -0.3 to 6.5 | V |
| Output Voltage Range | V _{out} | -0.3 to 6.5 | V |
| Output Voltage/Sense Input Range, SENSE/ADJ | V _{ADJ} | -0.3 to 6.5 | V |
| ESD Capability | Human Body Model Machine Model | 4000 200 | V |
| Maximum Junction Temperature | T _{J(MAX)} | 150 | °C |
| Storage Temperature Range | T _{STG} | -65 to 150 | °C |

Stresses exceeding Maximum Ratings may damage the device. Maximum Ratings are stress ratings only. Functional operation above the Recommended Operating Conditions is not implied. Extended exposure to stresses above the Recommended Operating Conditions may affect device reliability.

NOTE: This device series contains ESD Protection and exceeds the following tests:

ESD Human Body Model tested per AEC-Q100-002 (EIA/JESD22-A114)

ESD Machine Model tested per AEC-150 mA per JEDEC standard: JESD78Q100-003 (EIA/JESD22-A115)

Latchup Current Maximum Rating: ≤ 150 mA per JEDEC standard: JESD78.

1. Minimum V_{in} = (V_{out} + V_{DO}) or 1.5 V, whichever is higher.

THERMAL CHARACTERISTICS

| Rating | Symbol | Value | Unit |
|--------------------------------------------------|------------------|-------|------|
| Thermal Resistance, Junction-to-Ambient (Note 2) | R _{θJA} | 75 | °C/W |
| Thermal Resistance, Junction-to-Case | R _{ψJC} | 18 | °C/W |

2. Soldered on 645 mm², 1 oz copper area, FR4. Refer to ELECTRICAL CHARACTERISTICS and APPLICATION INFORMATION for Safe Operating Area.

OPERATING RANGES (Note 3)

| Rating | Symbol | Value | Unit |
|--------------------------------|------------------|------------|------|
| Input Voltage (Note 4) | V _{in} | 1.5 to 6.0 | V |
| Output Current (Notes 5 and 6) | I _{out} | 0 to 675 | mA |
| Junction Temperature | T _J | -40 to 150 | °C |
| Ambient Temperature | T _A | -40 to 125 | °C |

3. Refer to Electrical Characteristics and Application Information for Safe Operating Area.

4. Minimum V_{in} = (V_{out} + V_{DO}) or 1.5 V, whichever is higher.

5. Minimum limit valid for fixed versions only. For more details refer to Application Information Section.

6. Maximum limit for V_{out} = V_{out(nom)} - 10%.

NCP605, NCP606

ELECTRICAL CHARACTERISTICS

$V_{in} = (V_{out} + 0.5 \text{ V})$ or 1.5 V, whichever is higher, $C_{in} = 1 \mu\text{F}$, $C_{out} = 1 \mu\text{F}$, for typical values $T_A = 25^\circ\text{C}$, for min/max values $T_A = -40^\circ\text{C}$ to 85°C ; unless otherwise noted. (Notes 9 and 10)

| Parameter | Test Conditions | Symbol | Min | Typ | Max | Unit |
|--------------------------------------------------------------------------------------------------------------------|-----------------------------------------------------------------------------------------------------------------------------------------------------------------------|--------------|----------------------------------------------------------------------|-----------------------------------------------|----------------------------------------------------------------------|---------------|
| Output voltage (Adjustable Version) | $V_{in} = 1.75 \text{ V to } 6 \text{ V}$ $I_{out} = 1 \text{ mA to } 500 \text{ mA}$ | V_{out} | 1.231 (-1.5%) | 1.250 | 1.269 (+1.5%) | V |
| Output voltage (Fixed Versions) | $V_{in} = (V_{out} + 0.5 \text{ V}) \text{ to } 6 \text{ V}$ $I_{out} = 1 \text{ mA to } 500 \text{ mA}$ | V_{out} | 1.470 1.764 2.450 2.744 2.940 3.234 4.900 (-2%) | 1.5 1.8 2.5 2.8 3.0 3.3 5.0 | 1.530 1.836 2.550 2.856 3.060 3.366 5.100 (+2%) | V |
| Line regulation | $V_{in} = (V_{out} + 0.5 \text{ V}) \text{ to } 6 \text{ V}$, $I_{out} = 1 \text{ mA}$ | Reg_{line} | - | 4 | 10 | mV |
| Load regulation | $I_{out} = 1 \text{ mA to } 500 \text{ mA}$ | Reg_{load} | - | 10 | 30 | mV |
| Dropout voltage (Adjustable Version) (Note 9) | $V_{DO} = V_{in} - V_{out}$ $V_{out} = 1.25 \text{ V}$ $I_{out} = 500 \text{ mA}$ | V_{DO} | - | 450 | 470 | mV |
| Dropout voltage (Fixed Version) | $V_{DO} = V_{in} - (V_{out} - 0.1 \text{ V})$ $I_{out} = 500 \text{ mA}$ $V_{out} = 0 \text{ V to } 90\% V_{out(nom)}$ | V_{DO} | - - - - - - - | 290 250 200 190 180 170 150 | 360 300 250 240 230 220 200 | mV |
| Disable Current (NCP606 Only) (Note 10) | $V_{EN} = 0 \text{ V}$ | I_{DIS} | - | 0.1 | 1 | μA |
| Ground Current | $I_{out} = 1 \text{ mA to } 500 \text{ mA}$ | I_{GND} | - | 145 | 180 | μA |
| Current Limit (Note 11) | $V_{out} = V_{out(nom)} - 10\%$ | I_{LIM} | 675 | - | - | mA |
| Output Short Circuit Current | $V_{out} = 0 \text{ V}$ | I_{SC} | 700 | 1000 | 1350 | mA |
| Enable Input Threshold Voltage (NCP606 Only) Voltage Increasing, Logic High Voltage Decreasing, Logic Low | High Low | $V_{th(EN)}$ | 0.9 - | - - | - 0.4 | V |
| Turn-on Time (Note 11) | $V_{in} = 0 \text{ V to } (V_{out} + 0.5 \text{ V}) \text{ or } 1.75 \text{ V}$, whichever is higher $V_{out} = 0 \text{ V to } 90\% \text{ of } V_{out(nom)}$ | t_{on} | - - - - - - - - | 6 6 7 8 10 12 15 30 | - - - - - - - - | μs |
| Enable Time (NCP606 Only) (Note 11) | $V_{EN} = \text{From } 0 \text{ V to } V_{in}$ | t_{EN} | - - - - - - - - | 12 12 13 16 18 19 20 30 | - - - - - - - - | μs |

7. Refer to ABSOLUTE MAXIMUM RATINGS and APPLICATION INFORMATION for Safe Operating Area.
8. Performance guaranteed over the indicated operating temperature range by design and/or characterization tested at $T_J = T_A = 25^\circ\text{C}$. Low duty cycle pulse techniques are used during testing to maintain the junction temperature as close to ambient as possible.
9. Maximum dropout voltage is limited to minimum input voltage $V_{in} = 1.7 \text{ V}$ recommended for guaranteed operation at maximum output current.
10. Refer to application information section.
11. Values based on design and/or characterization.

NCP605, NCP606

ELECTRICAL CHARACTERISTICS

$V_{in} = (V_{out} + 0.5 \text{ V})$ or 1.5 V, whichever is higher, $C_{in} = 1 \mu\text{F}$, $C_{out} = 1 \mu\text{F}$, for typical values $T_A = 25^\circ\text{C}$, for min/max values $T_A = -40^\circ\text{C}$ to 85°C ; unless otherwise noted. (Notes 9 and 10)

| Parameter | Test Conditions | Symbol | Min | Typ | Max | Unit |
|-----------------------------------------|---------------------------------------------------------------------------------------------------------------------------------------------------------------------------------------------------------|----------|-----|----------------|-----|---------------------|
| Power Supply Ripple Rejection (Note 11) | $I_{out} = 500 \text{ mA}$ $V_{out} = 1.25 \text{ V}$ $V_{in} - V_{out} = 1 \text{ V}$ $f = 120 \text{ Hz}, 0.5 V_{PP}$ $f = 1 \text{ kHz}, 0.5 V_{PP}$ $f = 10 \text{ kHz}, 0.5 V_{PP}$ | PSRR | – | 62 55 40 | – | dB |
| Output Noise Voltage (Note 11) | $f = 10 \text{ Hz to } 100 \text{ kHz}, V_{out} = 1.25 \text{ V}$ | V_n | – | 50 | – | μV_{rms} |
| Thermal Shutdown Temperature (Note 11) | | T_{SD} | – | 175 | – | $^\circ\text{C}$ |
| Thermal Shutdown Hysteresis (Note 11) | | T_{SH} | – | 10 | – | $^\circ\text{C}$ |

7. Refer to ABSOLUTE MAXIMUM RATINGS and APPLICATION INFORMATION for Safe Operating Area.
8. Performance guaranteed over the indicated operating temperature range by design and/or characterization tested at $T_J = T_A = 25^\circ\text{C}$. Low duty cycle pulse techniques are used during testing to maintain the junction temperature as close to ambient as possible.
9. Maximum dropout voltage is limited to minimum input voltage $V_{in} = 1.7 \text{ V}$ recommended for guaranteed operation at maximum output current.
10. Refer to application information section.
11. Values based on design and/or characterization.

TYPICAL CHARACTERISTICS

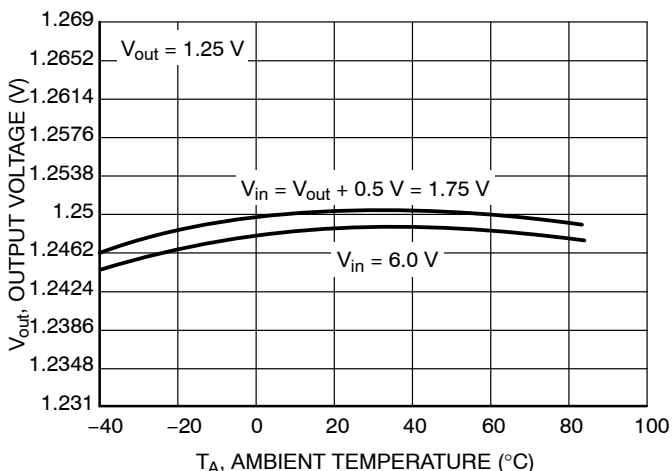

Figure 9. Output Voltage vs. Temperature ($V_{out} = 1.25\text{ V}$)

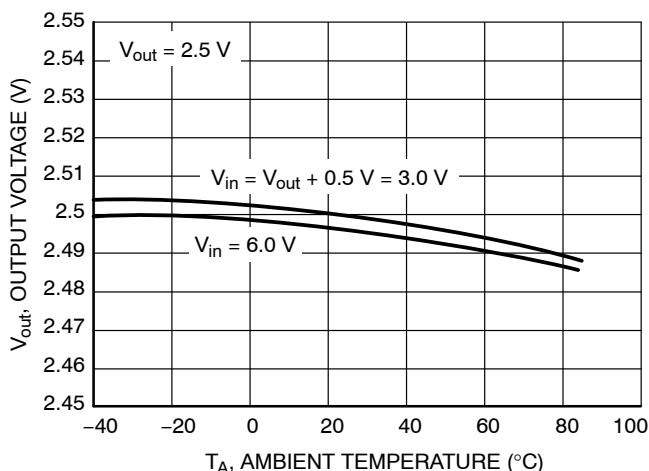

Figure 10. Output Voltage vs. Temperature ($V_{out} = 2.5\text{ V}$)

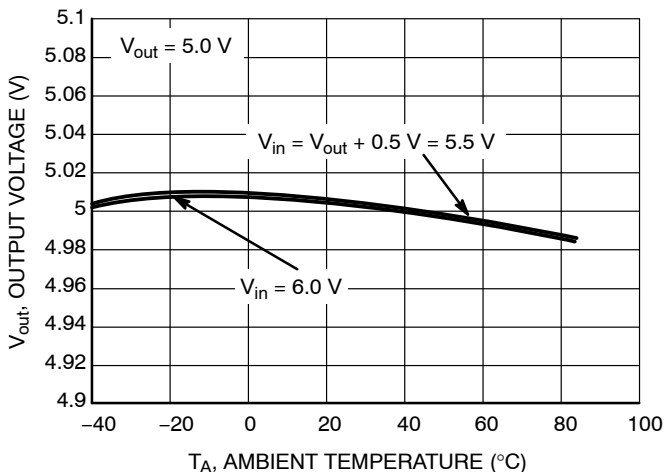

Figure 11. Output Voltage vs. Temperature ($V_{out} = 5.0\text{ V}$)

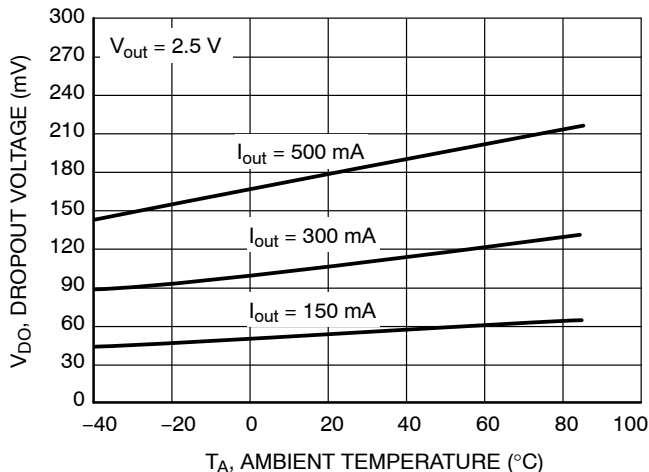

Figure 12. Dropout Voltage vs. Temperature ($V_{out} = 2.5\text{ V}$)

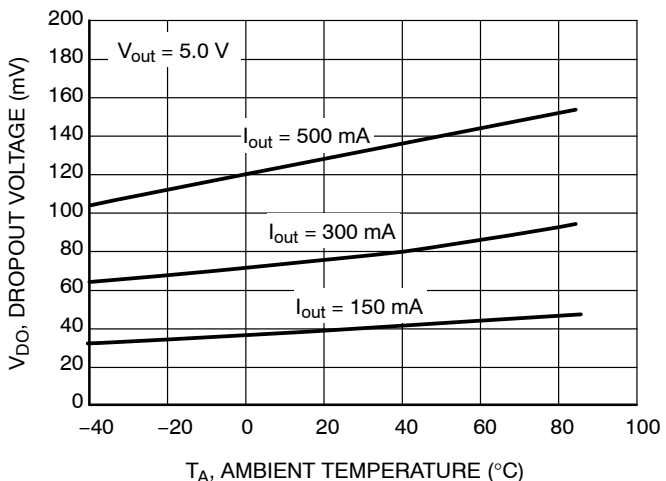

Figure 13. Dropout Voltage vs. Temperature ($V_{out} = 5.0\text{ V}$)

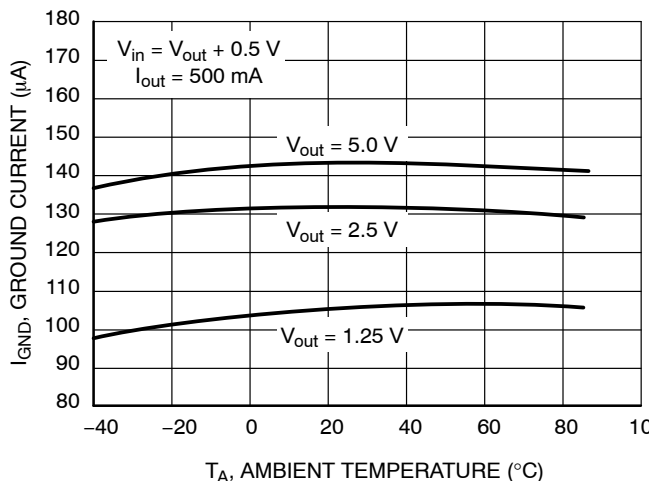

Figure 14. Ground Current vs. Temperature

NCP605, NCP606

TYPICAL CHARACTERISTICS

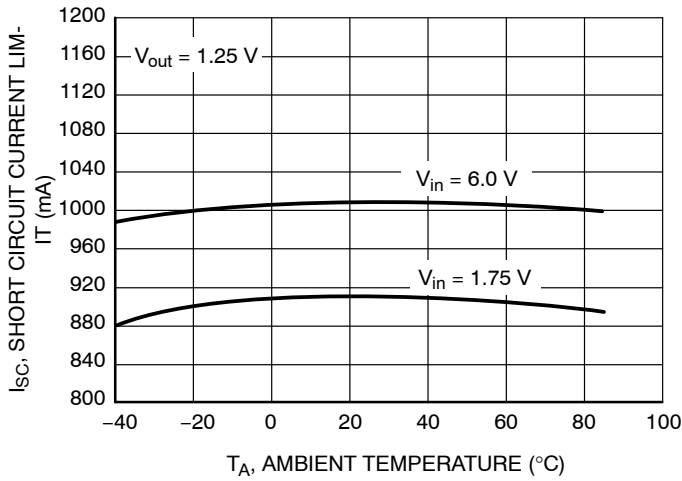

Figure 15. Short Circuit Current Limit vs. Temperature ($V_{out} = 1.25\text{ V}$)

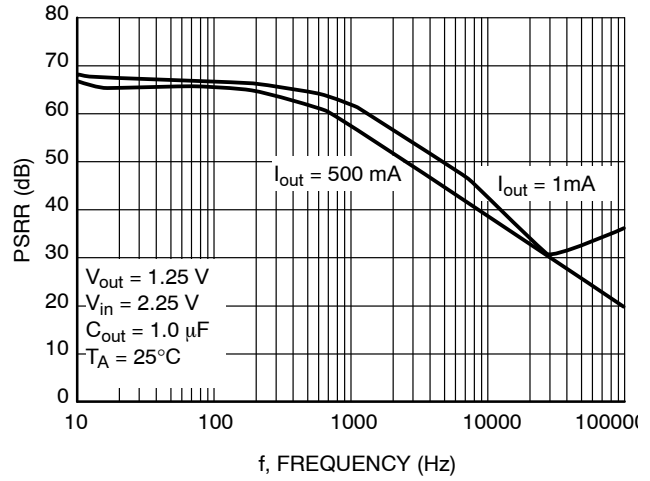

Figure 16. PSRR vs. Frequency ($V_{out} = 1.25\text{ V}$)

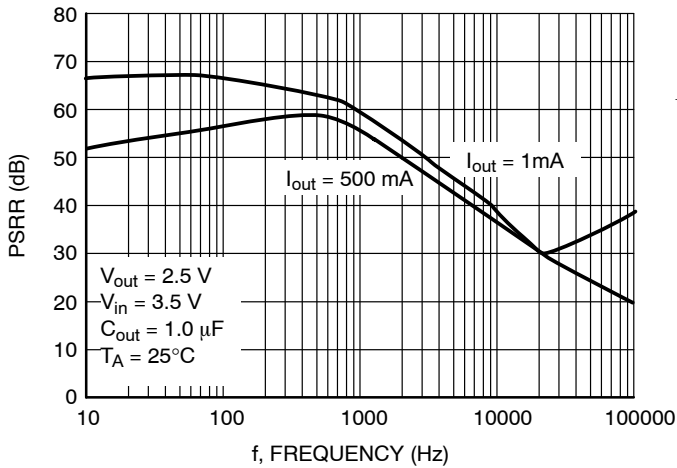

Figure 17. PSRR vs. Frequency ($V_{out} = 2.5\text{ V}$)

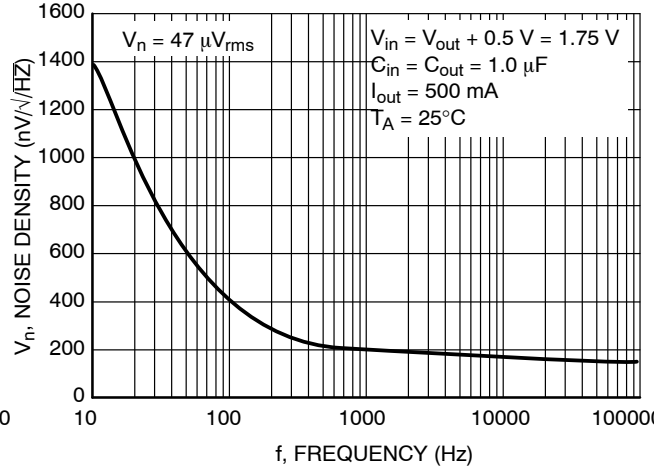

Figure 18. Noise Density vs. Frequency ($V_{out} = 1.25\text{ V}$)

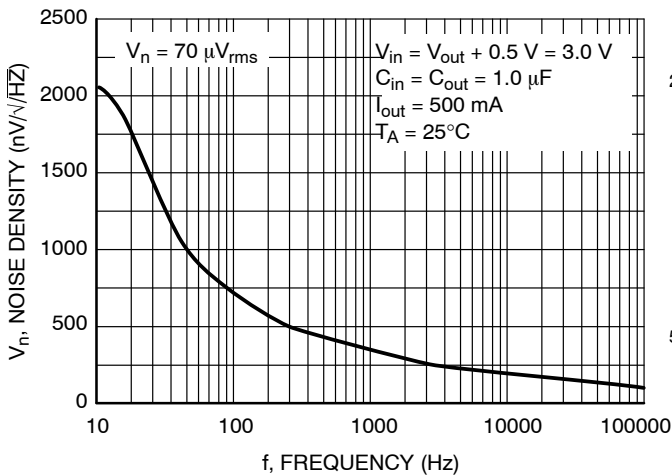

Figure 19. Noise Density vs. Frequency ($V_{out} = 2.5\text{ V}$)

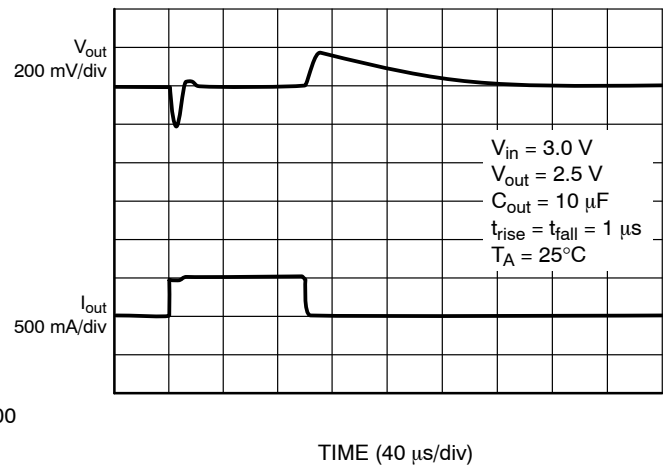

Figure 20. Load Transient ($V_{out} = 2.5\text{ V}$)

NCP605, NCP606

TYPICAL CHARACTERISTICS

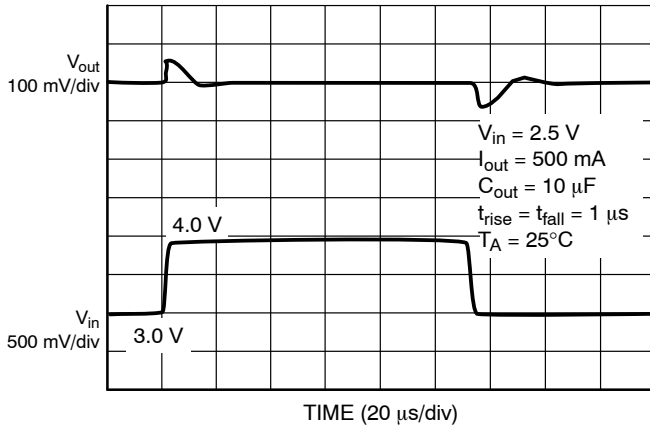

Figure 21. Line Transient ($V_{out} = 2.5$ V)

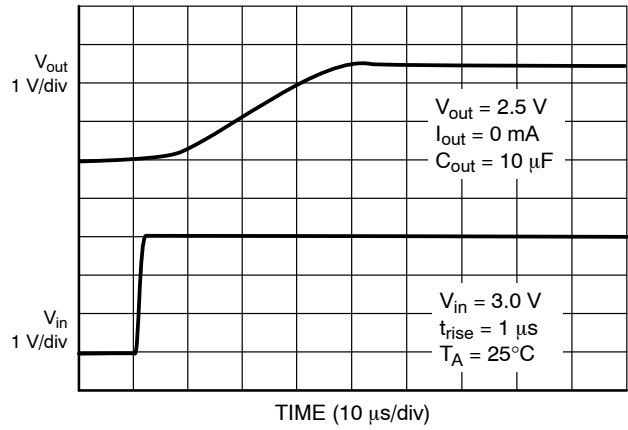

Figure 22. Startup Transient ($V_{out} = 2.5$ V)

DEFINITIONS

General

All measurements are performed using short pulse low duty cycle techniques to maintain junction temperature as close as possible to ambient temperature.

Line Regulation

The change in output voltage for a change in input voltage. The measurement is made under conditions of low dissipation or by using pulse techniques such that the average junction temperature is not significantly affected.

Load Regulation

The change in output voltage for a change in output load current at a constant temperature.

Dropout Voltage

The input to output differential at which the regulator output no longer maintains regulation against further reductions in input voltage. Measured when the output drops 100 mV below its nominal value. The junction temperature, load current, and minimum input supply requirements affect the dropout level.

Ground and Disable Currents

Ground Current is the current that flows through the ground pin when the regulator operates without a load on its output (I_{GND}). This consists of internal IC operation, bias, etc. It is actually the difference between the input current (measured through the LDO input pin) and the output load current. If the regulator has an input pin that reduces its internal bias and shuts off the output (enable/disable function), this term is called the disable current (I_{DIS}).

Current Limit and Short Circuit Current Limit

Current Limit is value of output current by which output voltage drops by 10% with respect to its nominal value.

Short Circuit Current Limit is output current value measured with output of the regulator shorted to ground.

PSRR

Power Supply Rejection Ratio is defined as ratio of output voltage and input voltage ripple. It is measured in decibels (dB).

Output Noise Voltage

This is the integrated value of the output noise over a specified frequency range. Input voltage and output load

current are kept constant during the measurement. Results are expressed in μV_{rms} or nV / \sqrt{Hz} .

Turn-on and Turn-off Times

Turn-on Time is time difference measured during power-up of the device from the moment when input voltage reaches 90% of its operating value to the moment when output voltage reaches 90% of its nominal value at specific output current or resistive load.

Turn-off Time is time difference measured during power-down of the device from the moment when input voltage drops to 10% of its operating value to the moment when output voltage drops to 10% of its nominal value at specific output current or resistive load.

Enable and Disable Times

Enable Time is time difference measured during power-up of the device from the moment when enable voltage reaches 90% of input voltage operating value to the moment when output voltage reaches 90% of its nominal value at specific output current or resistive load.

Disable Time is time difference measured during power-down of the device from the moment when enable voltage drops to 10% of input voltage operating value to the moment when output voltage drops to 10% of its nominal value at specific output current or resistive load.

Line Transient Response

Typical output voltage overshoot and undershoot response when the input voltage is excited with a given slope.

Load Transient Response

Typical output voltage overshoot and undershoot response when the output current is excited with a given slope between no-load and full-load conditions.

Thermal Protection

Internal thermal shutdown circuitry is provided to protect the integrated circuit in the event that the maximum junction temperature is exceeded. When activated at typically 175°C, the regulator turns off. This feature is provided to prevent failures from accidental overheating.

Maximum Package Power Dissipation

The power dissipation level at which the junction temperature reaches its maximum operating value.

APPLICATIONS INFORMATION

The NCP605/NCP606 regulator is self-protected with internal thermal shutdown and internal current limit. Typical application circuits are shown in Figures 1 to 4.

Input Decoupling (C_{in})

A ceramic or tantalum 1.0 μ F capacitor is recommended and should be connected close to the NCP605/NCP606 package. Higher capacitance and lower ESR will improve the overall line transient response.

Output Decoupling (C_{out})

The NCP605/NCP606 is a stable component and does not require a minimum Equivalent Series Resistance (ESR) for the output capacitor. The minimum output decoupling value is 1.0 μ F and can be augmented to fulfill stringent load transient requirements. The regulator works with ceramic chip capacitors as well as tantalum devices. Larger values improve noise rejection and load regulation transient response. Typical characteristics were measured with Murata ceramic capacitors. GRM219R71E105K (1 μ F, 25 V, X7R, 0805) and GRM21BR71A106K (10 μ F, 10 V, X7R, 0805).

No-Load Regulation Considerations

The NCP605/NCP606 adjustable regulator will operate properly under conditions where the only load current is through the resistor divider that sets the output voltage. However, in the case where the NCP605/NCP606 is configured to provide a 1.250 V output, there is no resistor divider. If the part is enabled under no-load conditions, leakage current through the pass transistor at junction temperatures above 85°C can approach several microamps, especially as junction temperature approaches 150°C. If this leakage current is not directed into a load, the output voltage will rise up to a level approximately 20 mV above nominal.

The NCP605/ NCP606 contains an overshoot clamp circuit to improve transient response during a load current step release. When output voltage exceeds the nominal by approximately 20 mV, this circuit becomes active and clamps the output from further voltage increase. Tying the ENABLE pin to V_{in} (NCP606 only) will ensure that the part is active whenever the supply voltage is present, thus guaranteeing that the clamp circuit is active whenever leakage current is present.

When the NCP606 adjustable regulator is disabled, the overshoot clamp circuit becomes inactive and the pass transistor leakage will charge any capacitance on V_{out} . If no load is present, the output can charge up to within a few millivolts of V_{in} . In most applications, the load will present some impedance to V_{out} such that the output voltage will be inherently clamped at a safe level. A minimum load of 10 μ A is recommended.

Unlike LP8345, for NCP605/606 fixed voltage versions there is no limitation for minimum load current.

Noise Decoupling

The NCP605/NCP606 is a low noise regulator and needs no external noise reduction capacitor. Unlike other low noise regulators which require an external capacitor and have slow startup times, the NCP605/NCP606 operates without a noise reduction capacitor, has a typical 8 μ s turn-on time and achieves a 50 μ V_{rms} overall noise level between 10 Hz and 100 kHz.

Enable Operation (NCP606 Only)

The enable pin will turn the regulator on or off. The threshold limits are covered in the electrical characteristics table in this data sheet. The turn-on/turn-off transient voltage being supplied to the enable pin should exceed a slew rate of 10 mV/ μ s to ensure correct operation. If the enable function is not to be used then the pin should be connected to V_{in} .

Output Voltage Adjust

The output voltage can be adjusted from 1 times (Figure 4) to 4 times (Figure 3) the typical 1.250 V regulation voltage via the use of resistors between the output and the ADJ input. The output voltage and resistors are chosen using Equation 1 and Equation 2.

$$V_{out} = 1.250 \left(1 + \frac{R_1}{R_2} \right) + (I_{ADJ} \times R_1) \quad (\text{eq. 1})$$

$$R_2 \cong \frac{R_1}{\frac{V_{out}}{1.25} - 1} \quad (\text{eq. 2})$$

Input bias current I_{ADJ} is typically less than 150 nA. Choose R_1 arbitrarily to minimize errors due to the bias current and to minimize noise contribution to the output voltage. Use Equation 2 to find the required value for R_2 .

Thermal

As power in the NCP605/NCP606 increases, it might become necessary to provide some thermal relief. The maximum power dissipation supported by the device is dependent upon board design and layout. Mounting pad configuration on the PCB, the board material, and the ambient temperature affect the rate of junction temperature rise for the part. When the NCP605/NCP606 has good thermal conductivity through the PCB, the junction temperature will be relatively low with high power applications. The maximum dissipation the NCP605/NCP606 can handle is given by:

$$P_{D(MAX)} = \frac{[T_{J(MAX)} - T_A]}{R_{\theta JA}} \quad (\text{eq. 3})$$

Since T_J is not recommended to exceed 125°C ($T_{J(MAX)}$), then the NCP605/NCP606 soldered on 645 mm², 1 oz copper area, FR4 can dissipate up to 1.3 W when the ambient

NCP605, NCP606

temperature (T_A) is 25°C. See Figure 23 for $R_{\theta JA}$ versus PCB area.

The power dissipated by the NCP605/NCP606 can be calculated from the following equations:

$$P_D \approx V_{in}(I_{GND@I_{OUT}}) + I_{out}(V_{in} - V_{out}) \quad (\text{eq. 4})$$

or

$$V_{in(MAX)} \approx \frac{P_{D(MAX)} + (V_{out} \times I_{out})}{I_{out} + I_{GND}} \quad (\text{eq. 5})$$

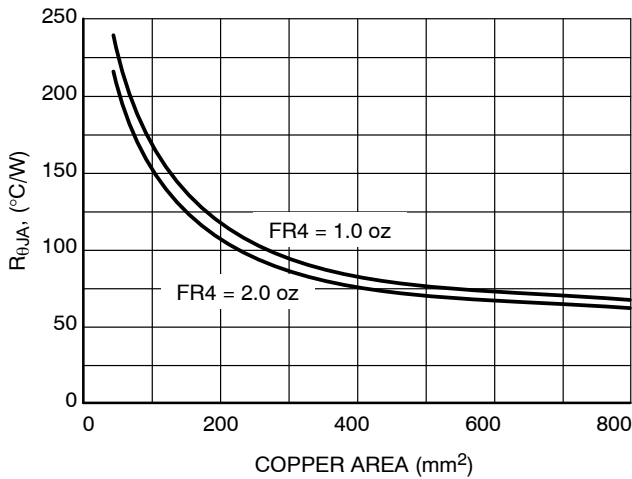

Figure 23. Thermal Resistance vs. Copper Area

Hints

V_{in} and GND printed circuit board traces should be as wide as possible. When the impedance of these traces is high, there is a chance to pick up noise or cause the regulator to malfunction. Place external components, especially the output capacitor, as close as possible to the NCP605/NCP606, and make traces as short as possible.

NCP605, NCP606

ORDERING INFORMATION

| Device | Nominal Output Voltage (V) | Marking | Package | Shipping† |
|----------------|----------------------------|-------------|-------------------|--------------------|
| NCP605MNADJT2G | ADJ | P605 ADJ | DFN6 (Pb-Free) | 3000 / Tape & Reel |
| NCP605MN15T2G | 1.5 | P605 150 | DFN6 (Pb-Free) | 3000 / Tape & Reel |
| NCP605MN18T2G | 1.8 | P605 180 | DFN6 (Pb-Free) | 3000 / Tape & Reel |
| NCP605MN25T2G | 2.5 | P605 250 | DFN6 (Pb-Free) | 3000 / Tape & Reel |
| NCP605MN28T2G | 2.8 | P605 280 | DFN6 (Pb-Free) | 3000 / Tape & Reel |
| NCP605MN30T2G | 3.0 | P605 300 | DFN6 (Pb-Free) | 3000 / Tape & Reel |
| NCP605MN33T2G | 3.3 | P605 330 | DFN6 (Pb-Free) | 3000 / Tape & Reel |
| NCP605MN50T2G | 5.0 | P605 500 | DFN6 (Pb-Free) | 3000 / Tape & Reel |
| NCP606MNADJT2G | ADJ | P606 ADJ | DFN6 (Pb-Free) | 3000 / Tape & Reel |
| NCP606MN15T2G | 1.5 | P606 150 | DFN6 (Pb-Free) | 3000 / Tape & Reel |
| NCP606MN18T2G | 1.8 | P606 180 | DFN6 (Pb-Free) | 3000 / Tape & Reel |
| NCP606MN25T2G | 2.5 | P606 250 | DFN6 (Pb-Free) | 3000 / Tape & Reel |
| NCP606MN28T2G | 2.8 | P606 280 | DFN6 (Pb-Free) | 3000 / Tape & Reel |
| NCP606MN30T2G | 3.0 | P606 300 | DFN6 (Pb-Free) | 3000 / Tape & Reel |
| NCP606MN33T2G | 3.3 | P606 330 | DFN6 (Pb-Free) | 3000 / Tape & Reel |
| NCP606MN50T2G | 5.0 | P606 500 | DFN6 (Pb-Free) | 3000 / Tape & Reel |

†For information on tape and reel specifications, including part orientation and tape sizes, please refer to our Tape and Reel Packaging Specifications Brochure, BRD8011/D.

MECHANICAL CASE OUTLINE

PACKAGE DIMENSIONS

ON Semiconductor®

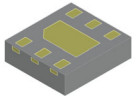

DFN6 3.0x3.3, 0.95P

CASE 506AX

ISSUE A

DATE 22 SEP 2020

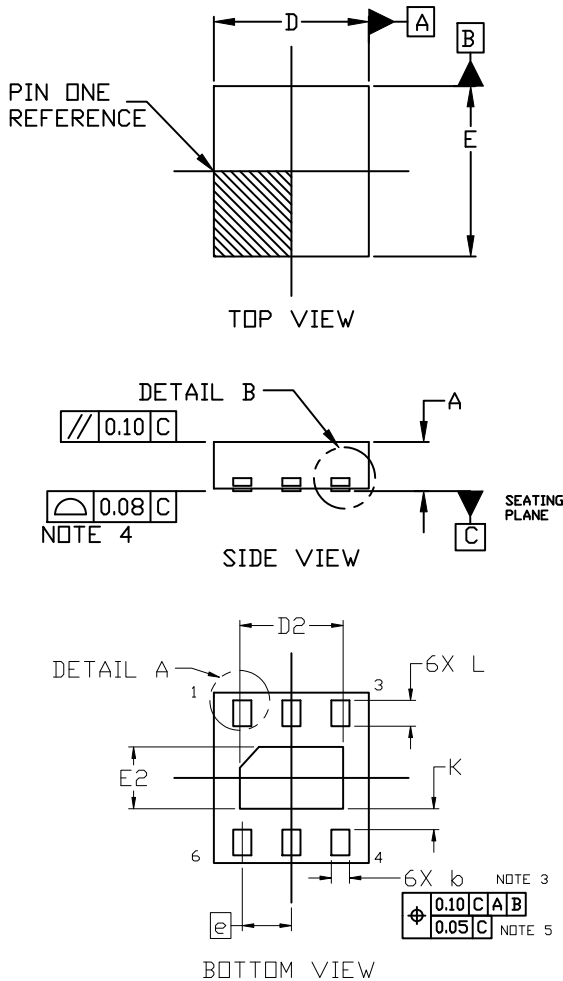

- NOTES:
1. DIMENSIONING AND TOLERANCING PER ASME Y14.5M, 2009.
 2. CONTROLLING DIMENSION: MILLIMETERS
 3. DIMENSION *b* APPLIES TO PLATED TERMINALS AND IS MEASURED BETWEEN 0.15 AND 0.30MM FROM THE TERMINAL TIP.
 4. COPLANARITY APPLIES TO THE EXPOSED PAD AS WELL AS THE TERMINALS.
 5. POSITIONAL TOLERANCE APPLIES TO THE EXPOSED PAD AS WELL AS THE TERMINALS.

| DIM | MILLIMETERS | | |
|-----|-------------|------|------|
| | MIN. | NOM. | MAX. |
| A | 0.80 | 0.90 | 1.00 |
| A1 | 0.00 | --- | 0.05 |
| b | 0.30 | 0.35 | 0.40 |
| D | 2.90 | 3.00 | 3.10 |
| D2 | 1.90 | 2.00 | 2.10 |
| E | 3.20 | 3.30 | 3.40 |
| E2 | 1.10 | 1.20 | 1.30 |
| e | 0.95 BSC | | |
| K | 0.40 REF | | |
| L | 0.40 | 0.50 | 0.60 |
| L1 | 0.00 | --- | 0.15 |

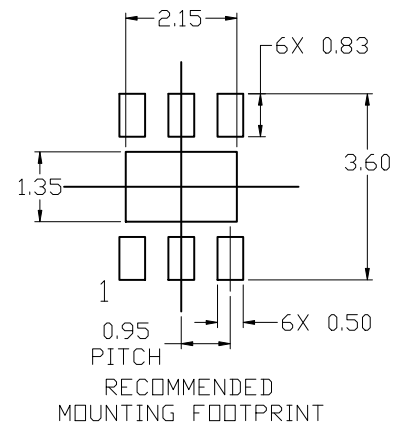

GENERIC MARKING DIAGRAM*

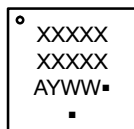

- XXXX = Specific Device Code
- A = Assembly Location
- Y = Year
- WW = Work Week
- = Pb-Free Package

(Note: Microdot may be in either location)

* For additional information on our Pb-Free strategy and soldering details, please download the ON Semiconductor Soldering and Mounting Techniques Reference Manual, SOLDERM/1.

*This information is generic. Please refer to device data sheet for actual part marking. Pb-Free indicator, "G" or microdot "▪", may or may not be present. Some products may not follow the Generic Marking.

| | | |
|-------------------------|----------------------------|----------------------------------------------------------------------------------------------------------------------------------------------------------------------------------|
| DOCUMENT NUMBER: | 98AON21930D | Electronic versions are uncontrolled except when accessed directly from the Document Repository. Printed versions are uncontrolled except when stamped "CONTROLLED COPY" in red. |
| DESCRIPTION: | DFN6 3.0X3.3, 0.95P | PAGE 1 OF 1 |

ON Semiconductor and ON are trademarks of Semiconductor Components Industries, LLC dba ON Semiconductor or its subsidiaries in the United States and/or other countries. ON Semiconductor reserves the right to make changes without further notice to any products herein. ON Semiconductor makes no warranty, representation or guarantee regarding the suitability of its products for any particular purpose, nor does ON Semiconductor assume any liability arising out of the application or use of any product or circuit, and specifically disclaims any and all liability, including without limitation special, consequential or incidental damages. ON Semiconductor does not convey any license under its patent rights nor the rights of others.

onsemi, **Onsemi**, and other names, marks, and brands are registered and/or common law trademarks of Semiconductor Components Industries, LLC dba "**onsemi**" or its affiliates and/or subsidiaries in the United States and/or other countries. **onsemi** owns the rights to a number of patents, trademarks, copyrights, trade secrets, and other intellectual property. A listing of **onsemi**'s product/patent coverage may be accessed at www.onsemi.com/site/pdf/Patent-Marking.pdf. **onsemi** reserves the right to make changes at any time to any products or information herein, without notice. The information herein is provided "as-is" and **onsemi** makes no warranty, representation or guarantee regarding the accuracy of the information, product features, availability, functionality, or suitability of its products for any particular purpose, nor does **onsemi** assume any liability arising out of the application or use of any product or circuit, and specifically disclaims any and all liability, including without limitation special, consequential or incidental damages. Buyer is responsible for its products and applications using **onsemi** products, including compliance with all laws, regulations and safety requirements or standards, regardless of any support or applications information provided by **onsemi**. "Typical" parameters which may be provided in **onsemi** data sheets and/or specifications can and do vary in different applications and actual performance may vary over time. All operating parameters, including "Typicals" must be validated for each customer application by customer's technical experts. **onsemi** does not convey any license under any of its intellectual property rights nor the rights of others. **onsemi** products are not designed, intended, or authorized for use as a critical component in life support systems or any FDA Class 3 medical devices or medical devices with a same or similar classification in a foreign jurisdiction or any devices intended for implantation in the human body. Should Buyer purchase or use **onsemi** products for any such unintended or unauthorized application, Buyer shall indemnify and hold **onsemi** and its officers, employees, subsidiaries, affiliates, and distributors harmless against all claims, costs, damages, and expenses, and reasonable attorney fees arising out of, directly or indirectly, any claim of personal injury or death associated with such unintended or unauthorized use, even if such claim alleges that **onsemi** was negligent regarding the design or manufacture of the part. **onsemi** is an Equal Opportunity/Affirmative Action Employer. This literature is subject to all applicable copyright laws and is not for resale in any manner.

PUBLICATION ORDERING INFORMATION

LITERATURE FULFILLMENT:

Email Requests to: orderlit@onsemi.com

onsemi Website: www.onsemi.com

TECHNICAL SUPPORT

North American Technical Support:

Voice Mail: 1 800-282-9855 Toll Free USA/Canada

Phone: 011 421 33 790 2910

Europe, Middle East and Africa Technical Support:

Phone: 00421 33 790 2910

For additional information, please contact your local Sales Representative

X-ON Electronics

Largest Supplier of Electrical and Electronic Components

Click to view similar products for [LDO Voltage Regulators](#) category:

Click to view products by [ON Semiconductor](#) manufacturer:

Other Similar products are found below :

[AP7363-SP-13](#) [L79M05TL-E](#) [PT7M8202B12TA5EX](#) [TCR3DF185,LM\(CT](#) [TCR3DF24,LM\(CT](#) [TCR3DF285,LM\(CT](#) [TCR3DF31,LM\(CT](#)
[TCR3DF45,LM\(CT](#) [MP2013GQ-33-Z](#) [059985X](#) [NCP4687DH15T1G](#) [701326R](#) [TCR2EN28,LF\(S](#) [NCV8170AXV250T2G](#)
[TCR3DF27,LM\(CT](#) [TCR3DF19,LM\(CT](#) [TCR3DF125,LM\(CT](#) [TCR2EN18,LF\(S](#) [AP2112R5A-3.3TRG1](#) [AP7315-25W5-7](#)
[IFX30081LDVGRNXUMA1](#) [NCV47411PAAJR2G](#) [AP2113KTR-G1](#) [AP2111H-1.2TRG1](#) [ZLDO1117QK50TC](#) [AZ1117IH-1.8TRG1](#)
[AZ1117ID-ADJTRG1](#) [TCR3DG12,LF](#) [MIC5514-3.3YMT-T5](#) [MIC5512-1.2YMT-T5](#) [MIC5317-2.8YM5-T5](#) [SCD7912BTG](#)
[NCP154MX180270TAG](#) [SCD33269T-5.0G](#) [NCV8170BMX330TCG](#) [NCV8170AMX120TCG](#) [NCP706ABMX300TAG](#)
[NCP153MX330180TCG](#) [NCP114BMX075TCG](#) [MC33269T-3.5G](#) [CAT6243-ADJCMT5T](#) [TCR3DG33,LF](#) [AP2127N-1.0TRG1](#)
[TCR4DG35,LF](#) [LT1117CST-3.3](#) [LT1117CST-5](#) [TAR5S15U\(TE85L,F\)](#) [TAR5S18U\(TE85L,F\)](#) [TCR3UG19A,LF](#) [TCR4DG105,LF](#)