

NCS5652, NCV5652

Dual Power Operational Amplifier

Description

The NCx5652 is a dual power operational amplifier with a versatile output stage configuration that allows conventional op–amp biasing or user tuning of efficiency, isolation, or current monitoring. Integrated flyback diodes protect the amplifiers during inductive load transients. Operating at supply voltages as low as 3.3 V, the NCx5652 is capable of delivering 500 mA of current while maintaining an excellent output swing. The integrated thermal shutdown circuit protects the NCx5652 from excessive power dissipation. A thermal warning flag is provided for external monitoring of the device, providing a flexible interface to a system’s microcontroller. This open–collector thermal flag output doubles as a $\overline{\text{DISABLE}}$ input that can be used to tri–state both amplifier outputs under user control. The 12–pin UDFN 3x3 mm package provides thermal robustness while achieving space savings on high density PCBs.

Features

- Operating Supply Voltage Range: 3.3 V to 13.2 V
- Output Supply Voltage Range: 3.3 V to 13.2 V
- High Current Drive: 500 mA Operating
- Thermal Flag: Open–collector for Flexible Interface
- Thermal Shutdown/ Disable Function
- Output Short Circuit Tolerable (1 A to Source or Ground)
- No Power Sequencing Required (V_{CC} , VC1, VC2)
- UDFN12 Package Features Wettable Flank for Improved Solderability
- NCV Prefix for Automotive and Other Applications Requiring Unique Site and Control Change Requirements; AEC–Q100 Qualified and PPAP Capable
- These Devices are Pb–Free, Halogen Free/BFR Free and are RoHS Compliant

Typical Applications

- Telecom
- Vcom Driver
- Small DC Brush Motors
- LED String Driver
- Electrochromic Driver



ON Semiconductor®

www.onsemi.com

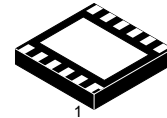

UDFN12
MU SUFFIX
CASE 517AM

MARKING DIAGRAM

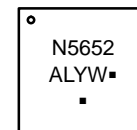

N5652 = Specific Device Code
A = Assembly Location
L = Wafer Lot
Y = Year
W = Work Week
▪ = Pb–Free Package
(Note: Microdot may be in either location)

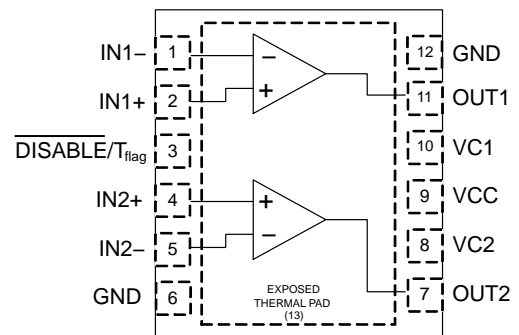

ORDERING INFORMATION

See detailed ordering and shipping information on page 12 of this data sheet.

NCS5652, NCV5652

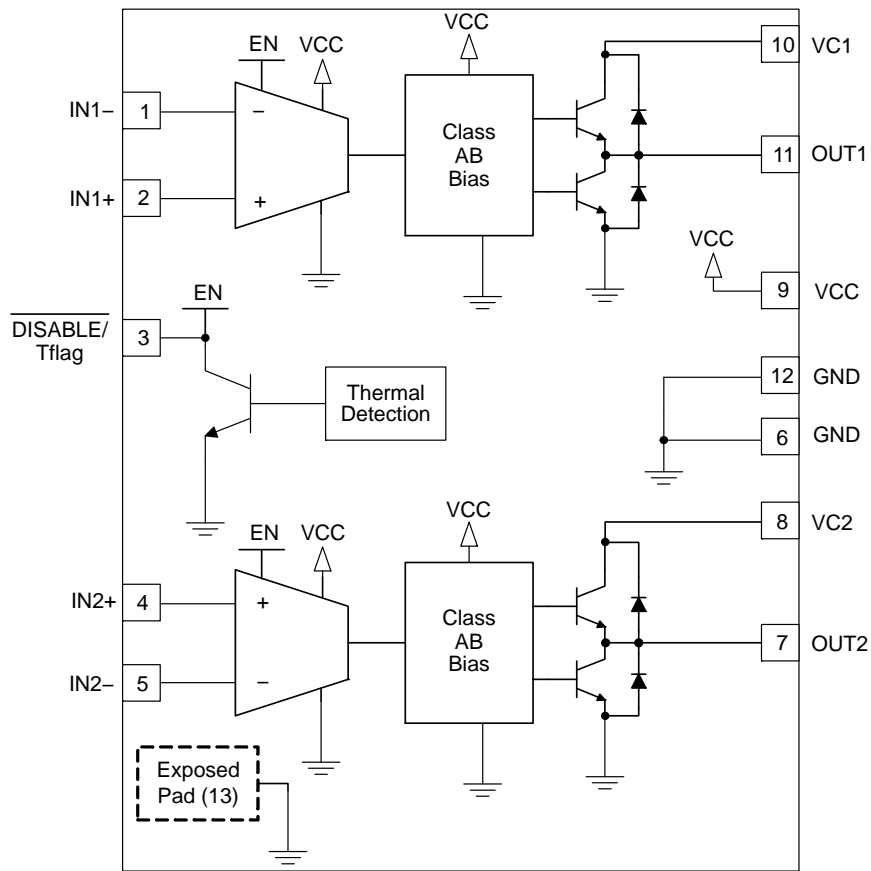

Figure 1. Block Diagram

Table 1. PIN DESCRIPTION

Pin	Name	Type	Description
1	IN1-	Input	Negative input of amplifier 1.
2	IN1+	Input	Positive input of amplifier 1.
3	DISABLE/Tflag	Input/Output	Dual use pin –Thermal flag– an open collector output requiring an external pull-up resistor. The output is pulled low when the thermal limit is reached. It is high-impedance in normal operation. Disable – Must use an open collector/drain for input with pull-up resistor to Vcc. Pulling pin low disables the amplifiers. If pin is not used, a pull-up resistor to Vcc is still required (10 KΩ recommended)
4	IN2+	Input	Positive input of amplifier 2.
5	IN2-	Input	Negative input of amplifier 2.
6	GND	Power	Power ground.
7	OUT2	Output	Output of amplifier 2.
8	VC2	Power	Positive supply of output stage 2.
9	VCC	Power	Positive supply of core circuitry.
10	VC1	Power	Positive supply of output stage 1.
11	OUT1	Output	Output of amplifier 1.
12	GND	Power	Power ground.
13	EXPOSED PAD	Power	The Exposed Pad must be attached to a heat-sinking conduit and connected to GND.

NCS5652, NCV5652

Table 2. ABSOLUTE MAXIMUM RATINGS Over operating free-air temperature, unless otherwise stated

Parameter	Symbol	Limit	Unit
Supply Voltage ($V_{CC} - GND$)	V_{CC}	16	V
Output Supply Voltage	VC1, VC2	16	V

INPUT AND OUTPUT PINS

Differential Input Voltage	V_{id}	$\pm V_{CC}$	V
Input Common Mode Voltage Range	V_{ICR}	-0.3 to $V_{CC} + 0.3$	V
Output Current (Note 1)	I_{OUT}	± 1000	mA
DISABLE/Tflag Pin Voltage (Note 2)	$V_{DISABLE/Tflag}$	7	V

TEMPERATURE

Storage Temperature	T_{STG}	-65 to 165	°C
Junction Temperature	$T_{J(MAX)}$	150	°C

ESD RATINGS (Note 3)

Human Body Model	HBM	± 1500 (IN-, Tflag pins). ± 2000 (All other pins)	V
Machine Model	MM	± 150 (IN-, Tflag pins). ± 200 (All other pins)	V
Charge Device Model	CDM	± 2500	V

Stresses exceeding those listed in the Maximum Ratings table may damage the device. If any of these limits are exceeded, device functionality should not be assumed, damage may occur and reliability may be affected.

1. Continuous short-to-ground or source; power dissipation must be taken into consideration.
2. Connected to voltage source via a pull-up resistor.
3. This device series incorporates ESD protection and is tested by the following methods:
 ESD Human Body Model tested per AEC-Q100-002 (JEDEC standard: JESD22-A114)
 ESD Machine Model tested per AEC-Q100-003 (JEDEC standard: JESD22-A115)
 ESD Charged Device Model tested per ANSI/ESD S5.3.1-2009 (AEC-Q100-011)

Table 3. THERMAL INFORMATION (Note 4)

Thermal Metric	Symbol	Limit	Unit
Junction to Ambient – UDFN12 (Exposed pad connected to 50 mm ² one ounce copper.)	θ_{JA}	147	°C/W
Junction to Ambient – UDFN12 (Exposed pad connected to 1200 mm ² one ounce copper.)	θ_{JA}	52	°C/W

4. Based on JEDEC.

Table 4. RECOMMENDED OPERATING CONDITIONS

Parameter	Symbol	Limit	Unit
Operating Supply Voltage	V_{CC}	3.3 to 13.2	V
Output Supply Voltage	VC1, VC2	3.3 to 13.2	V
Output Current (Note 5)	IC1, IC2	± 500	mA
Operating Temperature Range	T_A	-40 to +125	°C

Functional operation above the stresses listed in the Recommended Operating Ranges is not implied. Extended exposure to stresses beyond the Recommended Operating Ranges limits may affect device reliability.

5. Power dissipation must be taken into consideration to avoid thermal shutdown.

NCS5652, NCV5652

Table 5. ELECTRICAL CHARACTERISTICS: $V_{CC} = VC1 = VC2 = 5\text{ V}$

Boldface limits apply over the specified temperature range, $T_A = -40^\circ\text{C}$ to $+125^\circ\text{C}$.

At $T_A = +25^\circ\text{C}$, $R_L = 1\text{ k}\Omega$ connected to midsupply, $V_{OUT} = \text{midsupply}$, unless otherwise noted.

Parameter	Symbol	Conditions	Min	Typ	Max	Unit
-----------	--------	------------	-----	-----	-----	------

INPUT CHARACTERISTICS

Offset Voltage	V_{OS}			1	15	mV
Offset Voltage Drift	$\delta V/\delta T$			2		$\mu\text{V}/^\circ\text{C}$
Input Bias Current	I_{IB}			550	1000	nA
Input Offset Current	I_{OS}			10	100	nA
Input Common Mode Range (Note 6)	V_{CM}		0		3.8	V
Common Mode Rejection Ratio	CMRR		90	100		dB

OUTPUT CHARACTERISTICS (OUT1, OUT2)

Output Voltage High (Note 7)	V_{OH}	$V_{id} = 1\text{ V}, I_O = +250\text{ mA}$	4.0	4.15		V
Output Voltage Low	V_{OL}	$V_{id} = -1\text{ V}, I_O = -250\text{ mA}$		200	350	mV

DYNAMIC PERFORMANCE

Open Loop Voltage Gain	A_{VOL}		90	105		dB
Gain Bandwidth Product	GBWP	$R_L = 47\ \Omega, C_L = 100\text{ nF}$		350		kHz
Gain Margin	A_M	$R_L = 47\ \Omega, C_L = 100\text{ nF}$		6		dB
Phase Margin	ψ_M	$R_L = 47\ \Omega, C_L = 100\text{ nF}$		45		$^\circ$
Slew Rate	SR			1.5		V/ μs

POWER SUPPLY

Power Supply Rejection Ratio	PSRR	$V_{CC} = VC1 = VC2 = 3.3\text{ V to }13.2\text{ V}$	65	75		dB
Quiescent Current (Operating)	I_{CC}	No $R_L, C_L = 100\text{ nF}$		3	4	mA
Quiescent Current (Output)	I_{C1}, I_{C2}	(Per op amp) No $R_L, C_L = 100\text{ nF}$		4	6	mA

THERMAL CHARACTERISTICS

Thermal Shutdown (Note 8)	$T_{SHUTDOWN}$			160		$^\circ\text{C}$
---------------------------	----------------	--	--	-----	--	------------------

LOGIC CHARACTERISTICS (DISABLE/Tflag)

Output Voltage Low (Note 6)	V_{OL}	$I_{OL} = 1\text{ mA}$			0.7	V
Input Voltage High (Note 9)	V_{IH}		1.5			V
Input Voltage Low (Note 10)	V_{IL}				1.1	V

Product parametric performance is indicated in the Electrical Characteristics for the listed test conditions, unless otherwise noted. Product performance may not be indicated by the Electrical Characteristics if operated under different conditions.

6. V_{CM} is a function of V_{CC} ($V_{CC} - 1.2\text{ V}$).

7. V_{OH} is a function of V_{CC} ($V_{CC} - 0.8\text{ V}$).

8. Guaranteed by design/characterization.

9. DISABLE/Tflag pin with a pull-up resistor for sourcing.

10. DISABLE/Tflag pin with an open collector/drain for sinking.

TYPICAL CHARACTERISTICS

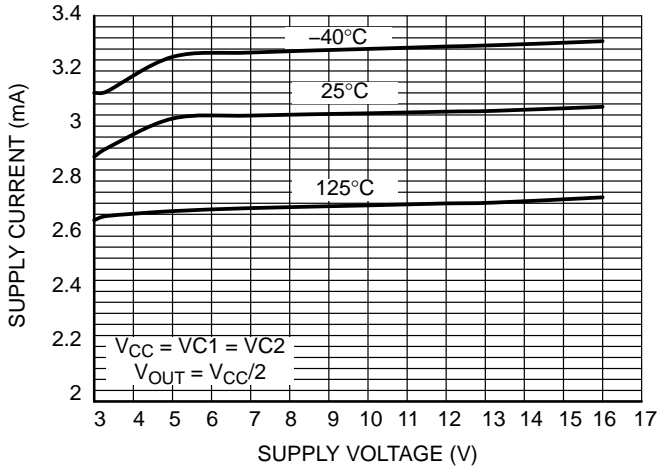

Figure 2. I_{CC} Quiescent Current vs. Supply Voltage over Temperature

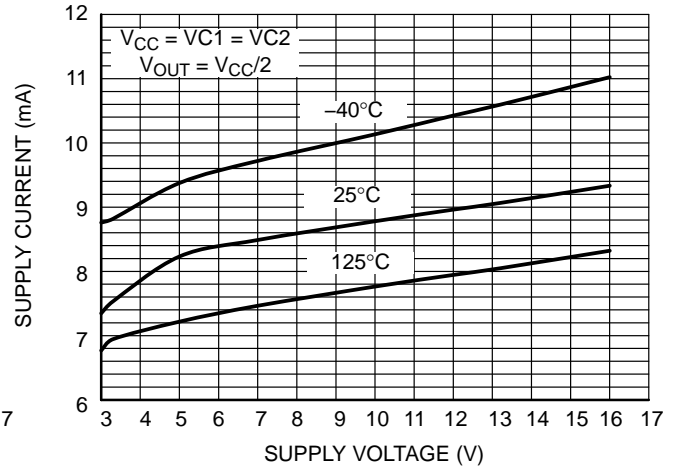

Figure 3. I_C Quiescent Current vs. Supply Voltage over Temperature (I_{C1} , I_{C2} combined)

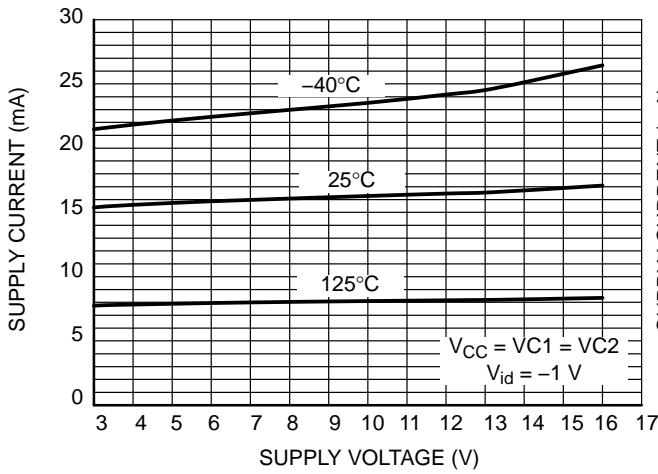

Figure 4. Comparator Mode (Negative), I_{CC} Quiescent Current vs Supply Voltage

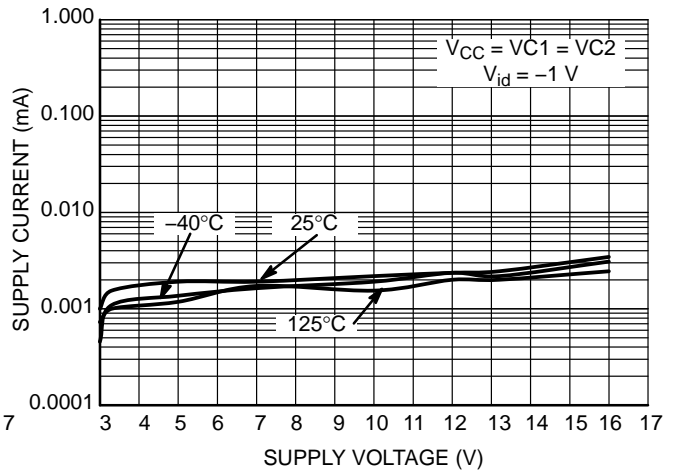

Figure 5. Comparator Mode (Negative), I_C Quiescent Current vs Supply Voltage (I_{C1} , I_{C2} Combined)

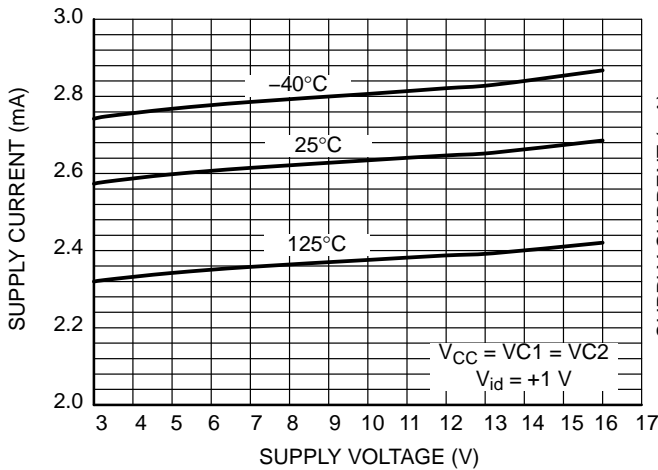

Figure 6. Comparator Mode (Positive), I_{CC} Quiescent Current vs Supply Voltage

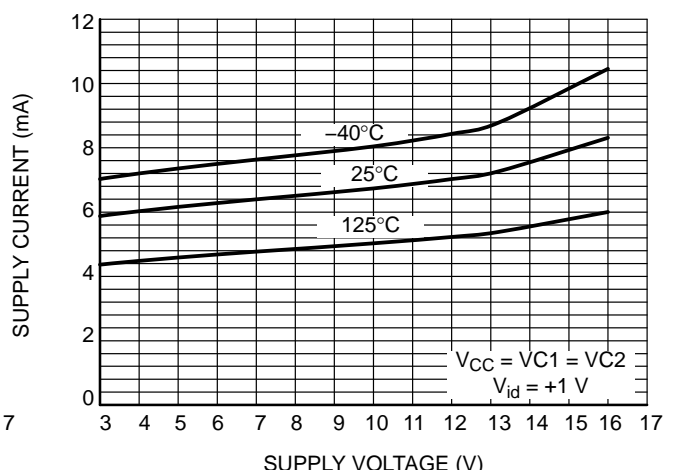

Figure 7. Comparator Mode (Positive), I_C Quiescent Current vs Supply Voltage (I_{C1} , I_{C2} Combined)

TYPICAL CHARACTERISTICS

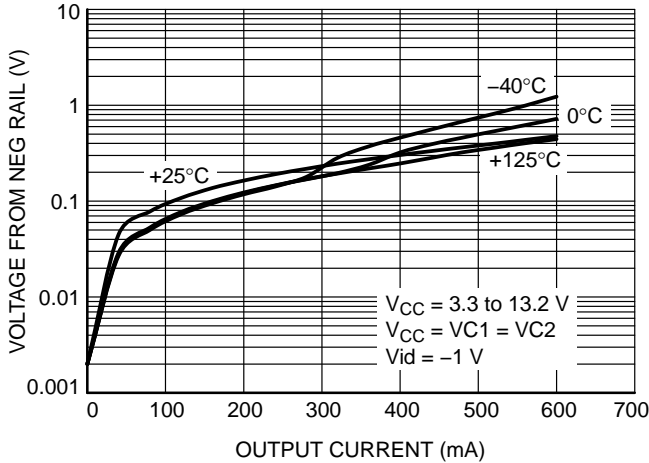

Figure 8. Low Level Output Voltage vs. Output Current Over Temperature

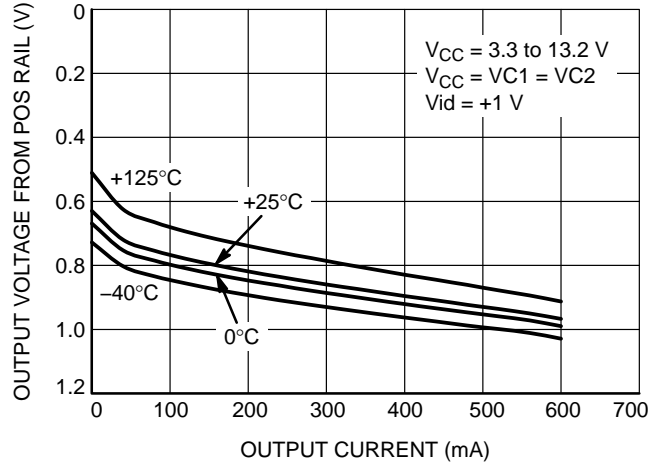

Figure 9. High Level Output Voltage vs. Output Current Over Temperature

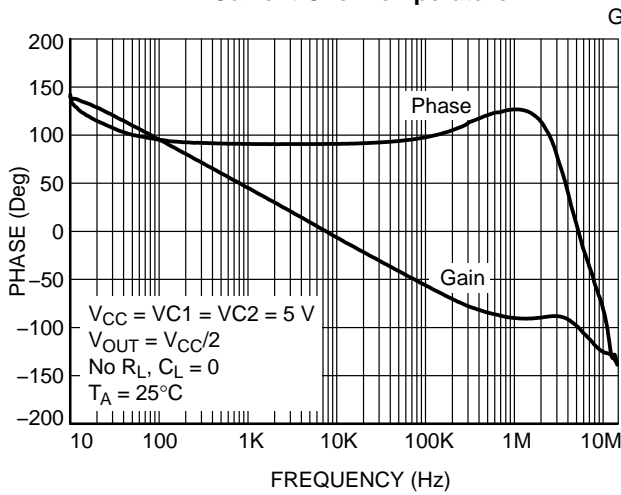

Figure 10. Open Loop Gain/Phase (No R_L , $C_L = 0$)

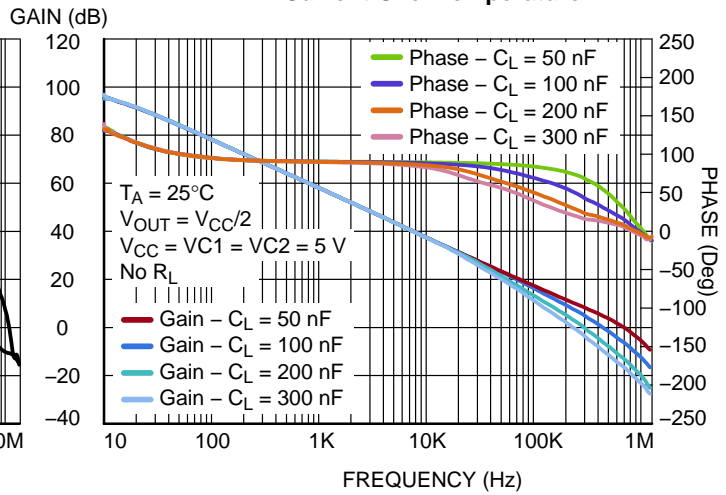

Figure 11. Open Loop Gain/Phase (No R_L , $C_L = \text{Varied}$)

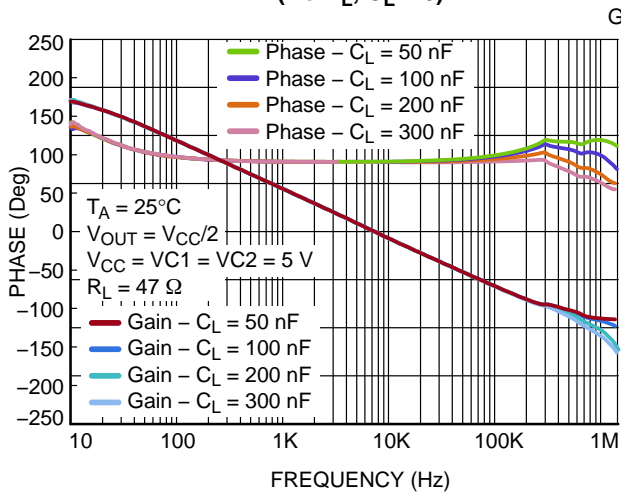

Figure 12. Open Loop Gain/Phase ($R_L = 47 \Omega$, $C_L = \text{Varied}$)

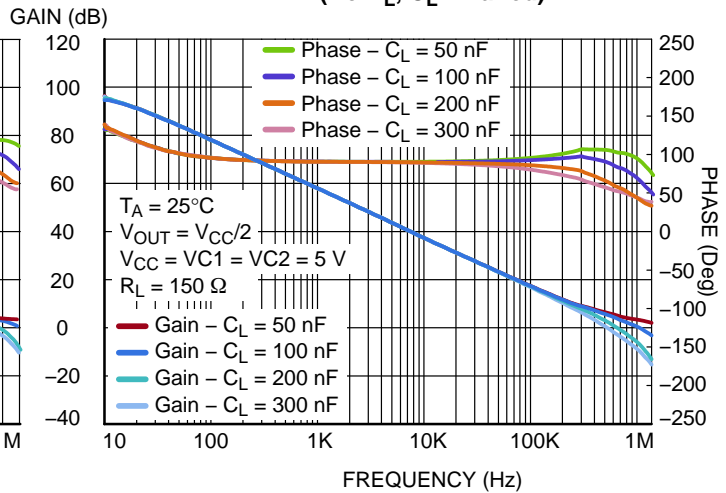

Figure 13. Open Loop Gain/Phase ($R_L = 150 \Omega$, $C_L = \text{Varied}$)

NCS5652, NCV5652

TYPICAL CHARACTERISTICS

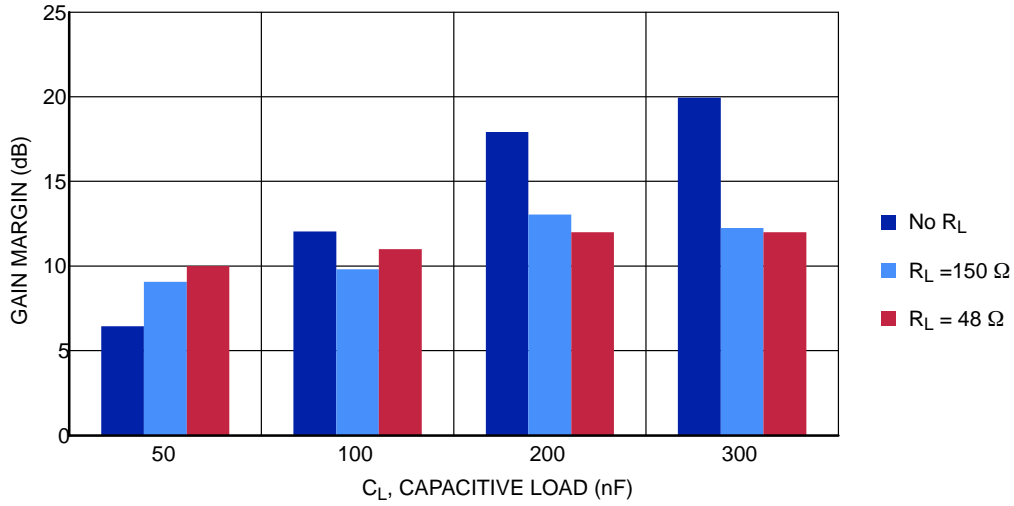

Figure 14. Gain Margin vs. Load

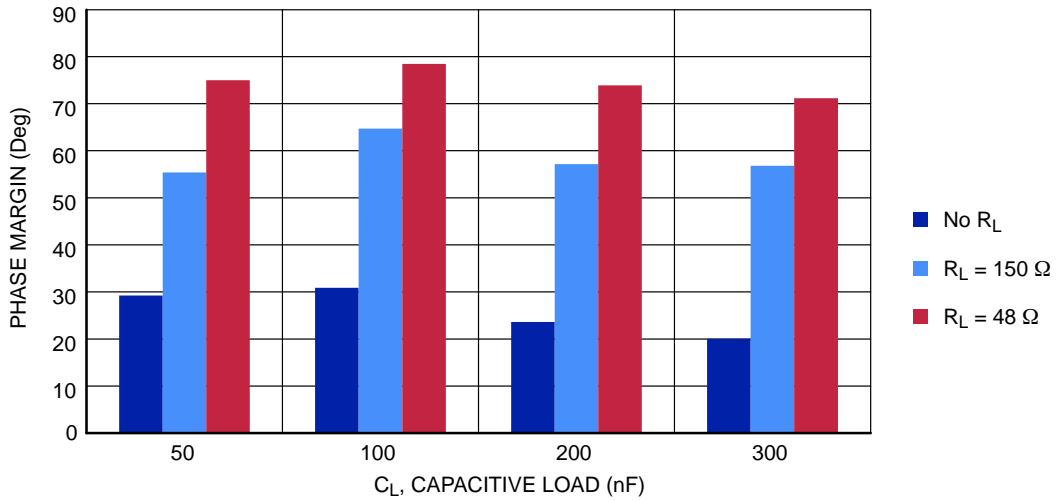

Figure 15. Phase Margin vs. Load

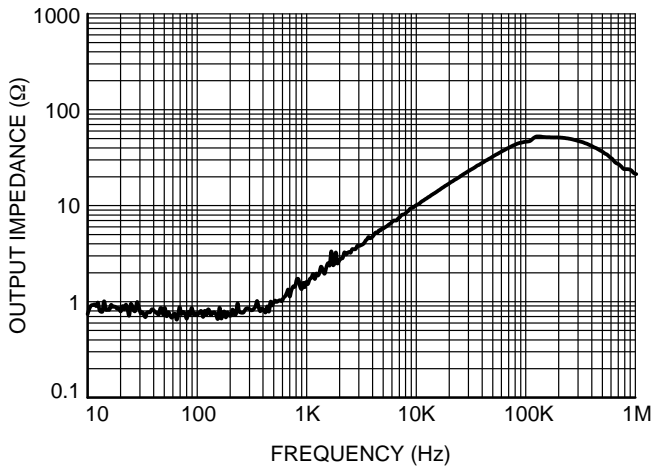

Figure 16. Open Loop Output Impedance vs. Frequency

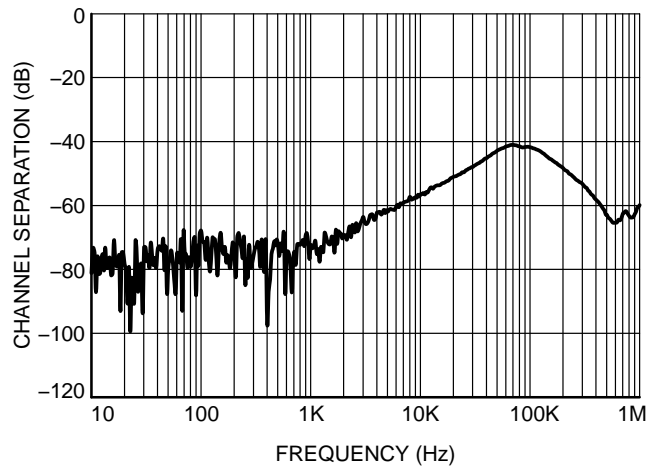

Figure 17. Channel Separation vs. Frequency

TYPICAL CHARACTERISTICS

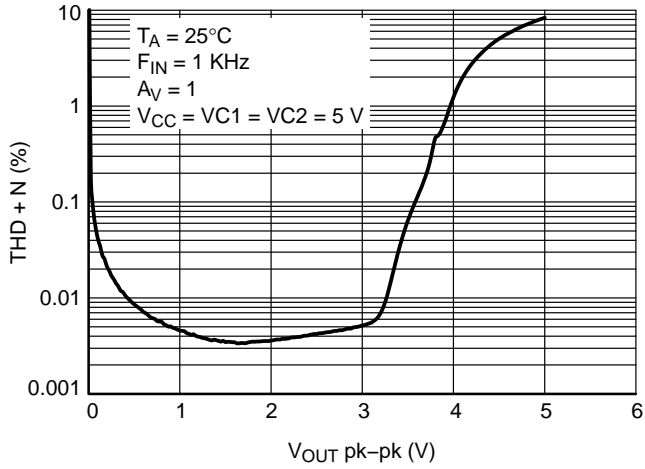

Figure 18. Total Harmonic Distortion + Noise vs. Vout

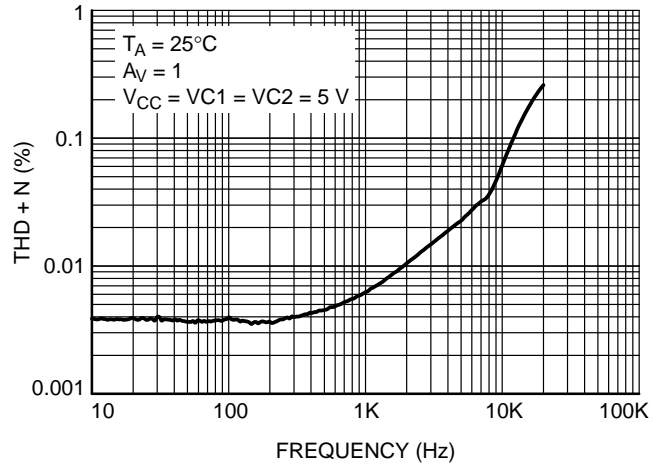

Figure 19. Total Harmonic Distortion + Noise vs. Frequency

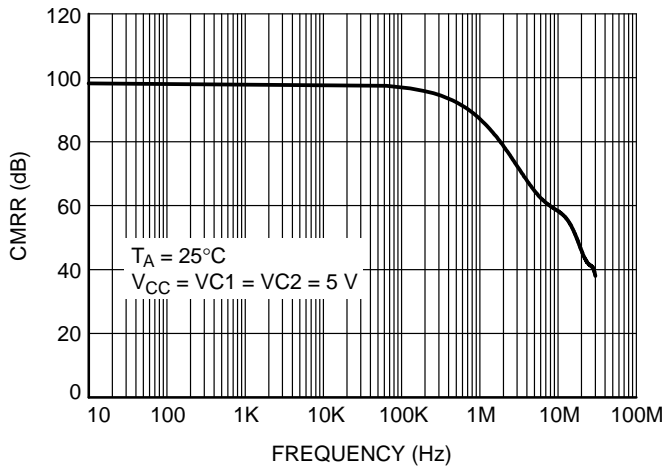

Figure 20. CMRR vs. Frequency

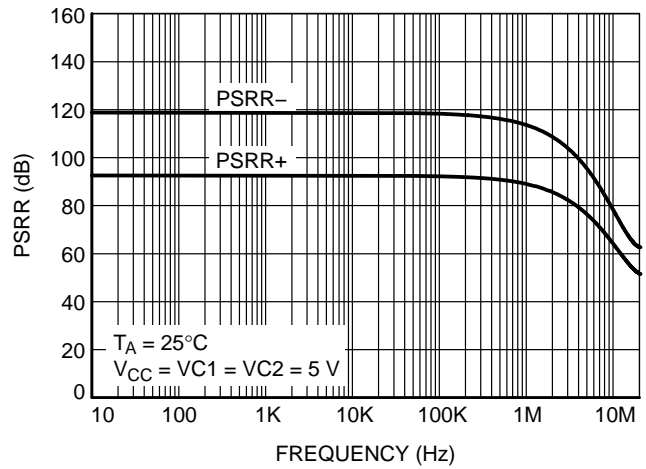

Figure 21. PSRR vs. Frequency

APPLICATIONS INFORMATION

Figure 22 shows a typical application on how to connect the NCx5652 pins where the V_{CC} is supplied by 5 V and the output stages are supplied with 12 V. In this configuration the inputs can be driven up to 3.8 V. The outputs can be as high as 4 V and able to go near ground due to the excellent V_{OL} parameters. The loads can be up to 500 mA continuous.

Power Supply

The supply pins should be properly bypassed with ceramic 0.1 μ F to 1 μ F capacitors. The different supply pins for the input stage (V_{CC}) and the output stage ($VC1, VC2$) provide a flexible power option. In many applications there is often a digital supply and different supply for driving motors or elements. The output stage can be optimized for the voltage requirements of the load. There are no requirements on the voltage levels (as long as they are within specification) and sequencing of the V_{CC} , $VC1$, and $VC2$ pins. It should be noted that the input and output swings are a function of V_{CC} . The common mode voltage range and output swings are specified in the electrical section according to the V_{CC} voltage.

Shutdown Feature

The NCx5652 provides a thermal shutdown feature to protect the device during fault conditions (See Output Short Circuit Protection section). Pin 3 is an open collector output that can be connected to a microcontroller to alert the system that a thermal shutdown has occurred. The thermal shutdown circuit has approximately 20°C hysteresis. When the device is in a thermal shutdown condition, the outputs are tri-stated. The same pin can be used for an input as well. It can be open collector OR'd so that the microcontroller can disable the device by driving this pin low. This pin must always be pulled high via a 10 k Ω resistor (recommended value). It should always be driven with an open collector/drain device. Some microcontrollers have open drain configurable outputs.

Stability

The NCx5652 is designed to drive large capacitive loads and not oscillate even at unity gain. It is recommended that a minimum of 0.1 μ F capacitor be placed on the outputs to ensure stability. This is mainly required for no load or light load conditions. If configuring the device as a follower, it is also recommended to use a 10 k Ω feedback resistor as shown in **Figure 22**.

Thermal Considerations

As power in the NCx5652 increases, it might become necessary to provide some thermal relief. The maximum power dissipation supported by the device is dependent upon board design and layout. Mounting pad configuration on the PCB, the board material, and the ambient temperature affect the rate of junction temperature rise for the part. When the NCS5652 has good thermal conductivity through the PCB, the junction temperature will be relatively low with

high power applications. The maximum dissipation the NCx5652 can handle is given by:

$$P_{D(MAX)} = \frac{[T_{J(MAX)} - T_A]}{R_{\theta JA}} \quad (\text{eq. 1})$$

Since T_J is not recommended to exceed 150°C, then the NCx5652 soldered on 1200 mm², 1 oz copper area, FR4 can dissipate up to 2.5 W when the ambient temperature (T_A) is 25°C.

Output Short Circuit Protection

The NCx5652 is designed to withstand short circuits on the outputs. With proper application design, the outputs can be shorted to ground or to a source up to 16 V without damage. Depending on the ambient temperature and thermal conductivity of the PCB, the device may enter thermal shutdown during a short circuit event. Even though the thermal shutdown disables the outputs, the application should not allow the outputs to be enabled continuously during a short circuit event when a thermal shutdown occurs. The **DISABLE/Tflag** pin (pin 3) should be monitored to recognize when a thermal shutdown event happens. And then respond within 5ms to disable the outputs for a minimum of 5 seconds (**DIS** and **DIS_{HOLD}** parameters in **Figure 23**). This low duty cycle keeps the device average junction temperature in a safe zone.

- **Output Short to Source**

When it is possible that the NCx5652 can be shorted to a source higher than $VC1, VC2$, a diode (D1) should be used to prevent current flow going back to the $VC1, VC2$ source as shown in **Figure 22**. The worst case for this event is when V_{OUT} is low (V_{OL}). **Figure 23** shows a diagram short from low to high ($V_{OUT} = V_{OL}$ shorted to 12 V–16 V). Note that when the short circuit current (I_{SC}) is low, the device is either operating normal or the outputs are disabled (tri-stated). **Table 6** shows typical values for I_{SC-PK} and $I_{SC-CLAMP}$. The parameter $I_{SC-HOLD}$ is the time it takes the device to enter thermal shutdown. This parameter varies depending on the ambient temperature and the thermal conductivity of the PCB. If the device thermal limit is not reached, the output current will stay clamped to the $I_{SC-CLAMP}$ value.

As stated earlier, the device should be disabled as soon as thermal shutdown occurs (noted by T_{SHDN} in **figure 23**). After T_{SHDN} occurs the device thermal shutdown circuit will disable the outputs for approximately 20ms before enabling them again (a characteristic from the thermal shutdown hysteresis). To allow variations of conditions, it is recommended that the microcontroller responds within 5ms (**DIS** parameter in **Table 6**) to keep pin 3 low. After a minimum of 5 seconds the microcontroller can then enable the outputs (indicated by the **EN** in **Figure 23**). This cycle will repeat until the short is removed from the outputs. **Figures 24 thru 26** show some typical values for an example

NCS5652, NCV5652

application using a 1200 mm² one ounce copper PCB. The microcontroller disables the outputs 1ms after detecting the thermal shutdown. Note that at -40°C thermal shutdown does not happen. Again the I_{SC-HOLD} parameter will vary with temperature and PCB characteristics.

It is possible that a short from low to high can disable the outputs and not cause a thermal shutdown. When the short is pulled significantly higher than V_{CC} (8–9 V), the high-side NPN protection circuit will be activated. This protection circuitry will turn off the current source providing the drive current to the output stage. This results in a very short I_{SC-PK} pulse and then disables the output. The output is disabled until the short is removed.

- Output short to ground

When possible, it is recommended that the application use current limiting resistors to limit the output current to 1 A

maximum when shorted to ground. This method helps distribute the heat between the NCx5652 and the current limiting resistors during normal operation and for a short to ground condition. Say that Figure 22 application example will have a 3 V maximum output with a full load of 300 mA. The R_{ILIM} resistors of 27 Ω are chosen so the voltage drop across them will be greater than 3 V at a full load of 300 mA. (V_{C1} = V_{C2} = 12 V - V_{D1} - (R_{ILIM} * 300 mA) = 3.2 V).

Worst case is the voltage across R_{ILIM} will be ~ 11.3 V. So maximum current = 11.3 V / 27 Ω ~ 420 mA.

If the power dissipation exceeds the thermal shutdown limit, the thermal shutdown circuit will disable the outputs. As discussed with the low to high short above, the microcontroller should disable the outputs within 5 ms and not enable them again for 5 seconds.

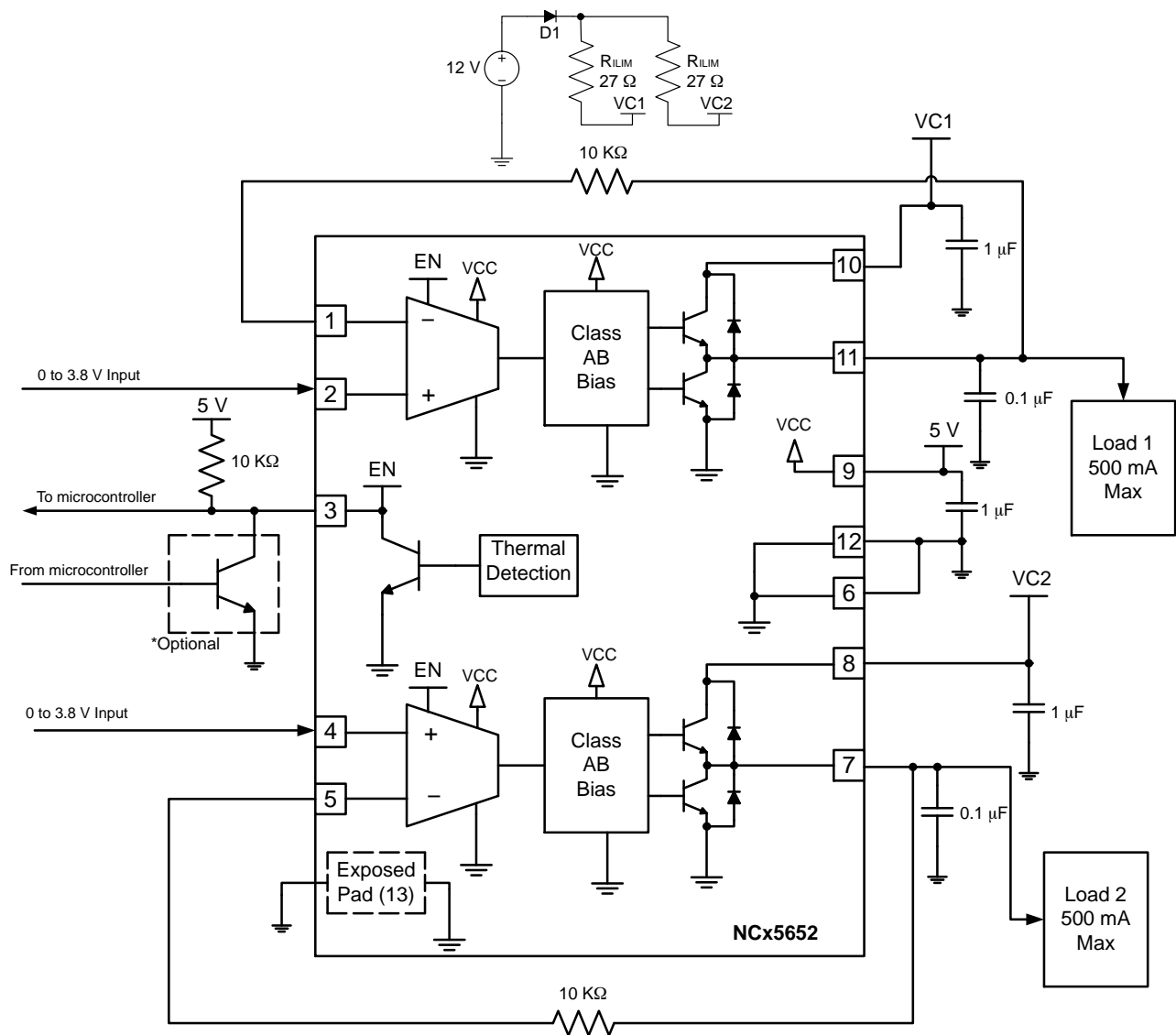

Figure 22. NCx5652 Application Diagram

NCS5652, NCV5652

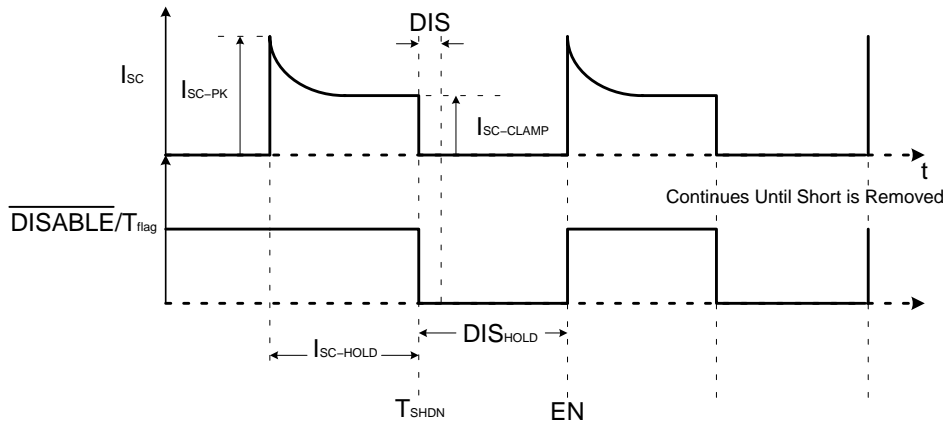

Figure 23. Output Short to Source. Output = V_{OL} Shorted to 12–16 V

Table 6. SHORT CIRCUIT PARAMETERS

Parameter	Symbol	Min	Typ	Max	Units
Peak Instantaneous Short Current	I_{SC-PK}		1000		mA
Short-Circuit Clamping Current	$I_{SC-CLAMP}$		600		mA
Disable Response Time after Thermal Shutdown	DIS	5			ms
Disable Hold Time	DIS_{HOLD}	5			seconds
Short Circuit Hold Time*	$I_{SC-HOLD}$		Varies		

*Short circuit hold time is dependent on ambient temperature and printed circuit board characteristics.

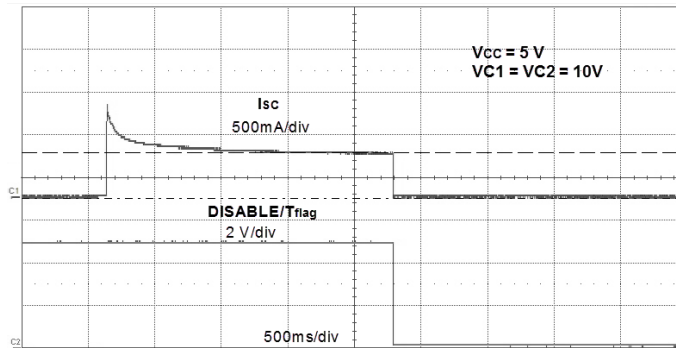

Figure 24. Output Short to Source. Output = V_{OL} Shorted to 12 V, $T_A = 25^\circ\text{C}$

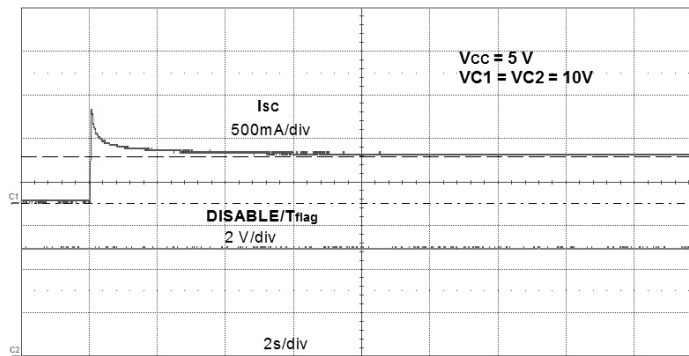

Figure 25. Output Short to Source. Output = V_{OL} Shorted to 12 V, $T_A = -40^\circ\text{C}$

NCS5652, NCV5652

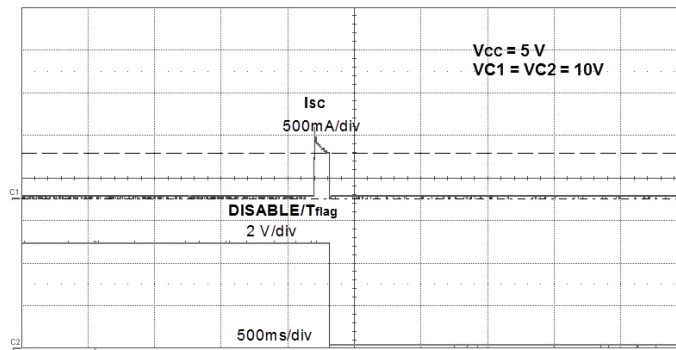

Figure 26. Output Short to Source. Output = V_{OL} Shorted to 12 V, $T_A = 125^\circ\text{C}$

ORDERING INFORMATION

Device	Automotive	Marking	Package	Shipping †
NCS5652MUTWG	No	N5652	UDFN12, 3x3 mm Pb-Free	3000 / Tape & Reel
NCV5652MUTWG	Yes	N5652	UDFN12, 3x3 mm Pb-Free	

†For information on tape and reel specifications, including part orientation and tape sizes, please refer to our Tape and Reel Packaging Specifications Brochure, BRD8011/D.

MECHANICAL CASE OUTLINE

PACKAGE DIMENSIONS

ON Semiconductor®



UDFN12 3x3, 0.5P
CASE 517AM
ISSUE A

DATE 22 JAN 2015

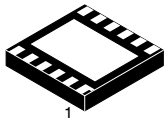

SCALE 4:1

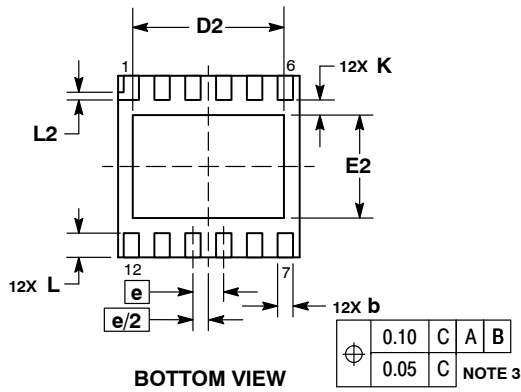
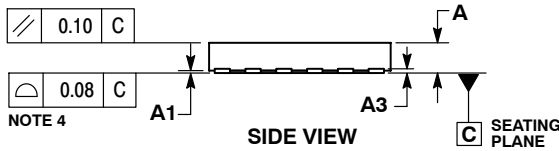
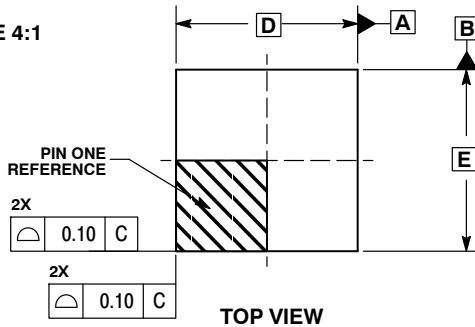

SOLDERING FOOTPRINT*

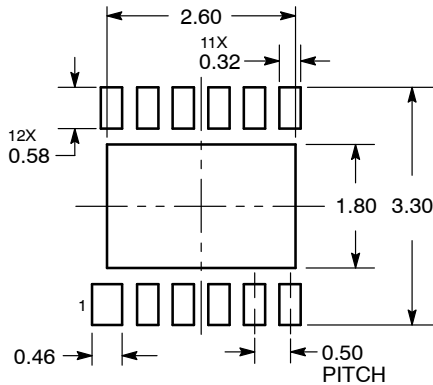

DIMENSIONS: MILLIMETERS

*For additional information on our Pb-Free strategy and soldering details, please download the ON Semiconductor Soldering and Mounting Techniques Reference Manual, SOLDERRM/D.

NOTES:

1. DIMENSIONING AND TOLERANCING PER ASME Y14.5M, 1994.
2. CONTROLLING DIMENSION: MILLIMETERS.
3. DIMENSION b APPLIES TO PLATED TERMINAL AND IS MEASURED BETWEEN 0.15 AND 0.30 MM FROM TERMINAL TIP.
4. COPLANARITY APPLIES TO THE EXPOSED PAD AS WELL AS THE TERMINALS.

DIM	MILLIMETERS	
	MIN	MAX
A	0.45	0.55
A1	0.00	0.05
A3	0.125	REF
b	0.20	0.30
D	3.00	BSC
D2	2.40	2.60
E	3.00	BSC
E2	1.60	1.80
e	0.50	BSC
K	0.20	---
L	0.30	0.50
L2	0.15	REF

GENERIC MARKING DIAGRAM*

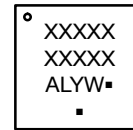

- A = Assembly Location
- L = Wafer Lot
- Y = Year
- W = Work Week
- = Pb-Free Package

(Note: Microdot may be in either location)

*This information is generic. Please refer to device data sheet for actual part marking. Pb-Free indicator, "G" or microdot "▪", may or may not be present.

DOCUMENT NUMBER:	98AON24906D	Electronic versions are uncontrolled except when accessed directly from the Document Repository. Printed versions are uncontrolled except when stamped "CONTROLLED COPY" in red.
DESCRIPTION:	UDFN12 3 X 3, 0.5P	PAGE 1 OF 1

ON Semiconductor and are trademarks of Semiconductor Components Industries, LLC dba ON Semiconductor or its subsidiaries in the United States and/or other countries. ON Semiconductor reserves the right to make changes without further notice to any products herein. ON Semiconductor makes no warranty, representation or guarantee regarding the suitability of its products for any particular purpose, nor does ON Semiconductor assume any liability arising out of the application or use of any product or circuit, and specifically disclaims any and all liability, including without limitation special, consequential or incidental damages. ON Semiconductor does not convey any license under its patent rights nor the rights of others.

onsemi, **Onsemi**, and other names, marks, and brands are registered and/or common law trademarks of Semiconductor Components Industries, LLC dba "**onsemi**" or its affiliates and/or subsidiaries in the United States and/or other countries. **onsemi** owns the rights to a number of patents, trademarks, copyrights, trade secrets, and other intellectual property. A listing of **onsemi**'s product/patent coverage may be accessed at www.onsemi.com/site/pdf/Patent-Marking.pdf. **onsemi** reserves the right to make changes at any time to any products or information herein, without notice. The information herein is provided "as-is" and **onsemi** makes no warranty, representation or guarantee regarding the accuracy of the information, product features, availability, functionality, or suitability of its products for any particular purpose, nor does **onsemi** assume any liability arising out of the application or use of any product or circuit, and specifically disclaims any and all liability, including without limitation special, consequential or incidental damages. Buyer is responsible for its products and applications using **onsemi** products, including compliance with all laws, regulations and safety requirements or standards, regardless of any support or applications information provided by **onsemi**. "Typical" parameters which may be provided in **onsemi** data sheets and/or specifications can and do vary in different applications and actual performance may vary over time. All operating parameters, including "Typicals" must be validated for each customer application by customer's technical experts. **onsemi** does not convey any license under any of its intellectual property rights nor the rights of others. **onsemi** products are not designed, intended, or authorized for use as a critical component in life support systems or any FDA Class 3 medical devices or medical devices with a same or similar classification in a foreign jurisdiction or any devices intended for implantation in the human body. Should Buyer purchase or use **onsemi** products for any such unintended or unauthorized application, Buyer shall indemnify and hold **onsemi** and its officers, employees, subsidiaries, affiliates, and distributors harmless against all claims, costs, damages, and expenses, and reasonable attorney fees arising out of, directly or indirectly, any claim of personal injury or death associated with such unintended or unauthorized use, even if such claim alleges that **onsemi** was negligent regarding the design or manufacture of the part. **onsemi** is an Equal Opportunity/Affirmative Action Employer. This literature is subject to all applicable copyright laws and is not for resale in any manner.

PUBLICATION ORDERING INFORMATION

LITERATURE FULFILLMENT:

Email Requests to: orderlit@onsemi.com

onsemi Website: www.onsemi.com

TECHNICAL SUPPORT

North American Technical Support:

Voice Mail: 1 800-282-9855 Toll Free USA/Canada

Phone: 011 421 33 790 2910

Europe, Middle East and Africa Technical Support:

Phone: 00421 33 790 2910

For additional information, please contact your local Sales Representative

X-ON Electronics

Largest Supplier of Electrical and Electronic Components

Click to view similar products for [Operational Amplifiers - Op Amps](#) category:

Click to view products by [ON Semiconductor](#) manufacturer:

Other Similar products are found below :

[NCV33072ADR2G](#) [LM358SNG](#) [430227FB](#) [UPC824G2-A](#) [LT1678IS8](#) [042225DB](#) [058184EB](#) [UPC822G2-A](#) [UPC259G2-A](#) [UPC258G2-A](#)
[NTE925](#) [AZV358MTR-G1](#) [AP4310AUMTR-AG1](#) [HA1630D02MMEL-E](#) [HA1630S01LPEL-E](#) [SCY33178DR2G](#) [NJU77806F3-TE1](#)
[NCV5652MUTWG](#) [NCV20034DR2G](#) [LM324EDR2G](#) [LM2902EDR2G](#) [NTE7155](#) [NTE778S](#) [NTE871](#) [NTE924](#) [NTE937](#) [MCP6V17T-](#)
[E/MNY](#) [MCP6V19-E/ST](#) [MXD8011HF](#) [MCP6V17T-E/MS](#) [SCY6358ADR2G](#) [ADA4523-1BCPZ](#) [LTC2065HUD#PBF](#) [ADA4523-1BCPZ-](#)
[RL7](#) [NJM2904CRB1-TE1](#) [2SD965T-R](#) [RS6332PXK](#) [BDM8551](#) [BDM321](#) [MD1324](#) [COS8052SR](#) [COS8552SR](#) [COS8554SR](#) [COS2177SR](#)
[COS2353SR](#) [COS724TR](#) [ASOPD4580S-R](#) [RS321BKXF](#) [ADA4097-1HUIJZ-RL7](#) [NCS20282FCTTAG](#)