

System Basis Chip with CAN, LIN, HS & LS Drivers

NCV7462

The NCV7462 is a monolithic LIN/CAN System-Basis-Chip with enhanced feature set useful in Automotive Body Control systems. Besides the bus interfaces the IC features two 5 V voltage regulators, high-side and low-side switches to control LED's and relays, and supervision functionality like a window watchdog. This allows a highly integrated solution by replacing external discrete components while maintaining the system flexibility. As a consequence, the board space and ECU weight can be minimized.

Features

- Main Supply Functional Operating Range from 5 V to 28 V
- Main Supply Parametrical Operating Range 6 V to 18 V
- CAN High Speed Transceiver Compliant to ISO11898
- TxD Time-out on CAN
- LIN Physical Layer According to LIN 2.x and SAEJ2602
- Programmable TxD Time-out on LIN
- Power Management Through Operating Modes: Normal, Standby, Sleep and Flash
- Low Drop Voltage Regulator VR1: 5 V / 250 mA, $\pm 2\%$ Output Tolerance
- Reverse Current Protected Low Drop Voltage Regulator VR2: 5 V / 50 mA, $\pm 2\%$ Output Tolerance
- 3x Wake-up Inputs, e.g. For Contact Monitoring
- Wake-up Logic with Cyclic Contact Monitoring
- Wake-up Source Recognition
- Independent PWM Functionality for All Outputs (integrated PWM registers)
- Window Watchdog with Programmable Times
- 2x Low-Side Driver (typ. 3 Ω) with Over-load Protection and Active Clamp; e.g. for Relays
- 1x High-Side Driver (typ. 1 Ω) with Over- and Under-load Detection and Auto-Recovery; e.g. for Bulbs, LED's and Switches
- 1x High-Side Driver (Selectable Between Typ. 2 Ω and 7 Ω) with Over- and Under-load Detection; e.g. for LED's and Switches
- 3x High-Side Driver (typ. 7 Ω) with Over- and Under-load Detection; e.g. for LED's and Switches
- 2x Operational Amplifier for Current Sensing
- 24-Bit SPI Interface
- Protection Against Short Circuit, Over-voltage and Over-temperature
- SSOP36-EP Package
- AEC-Q100 Qualified and PPAP Capable
- These Devices are Pb-Free, Halogen Free/BFR Free and are RoHS Compliant



ON Semiconductor®

www.onsemi.com

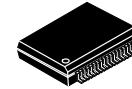

SSOP36-EP
DQ SUFFIX
CASE 940AB

MARKING DIAGRAM

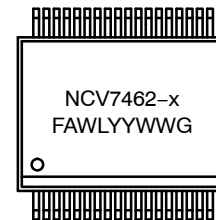

NCV7462-x = Specific Device Code
x = 0 or 1
F = Fab Location
A = Assembly Location
WL = Wafer Lot
YY = Year
WW = Work Week
G = Pb-Free Package

ORDERING INFORMATION

See detailed ordering and shipping information on page 54 of this data sheet.

Typical Applications like

- De-centralized Door Electronic Systems
- Body Control Units (BCUs)
- Climate Control Systems

NCV7462

PIN-OUT

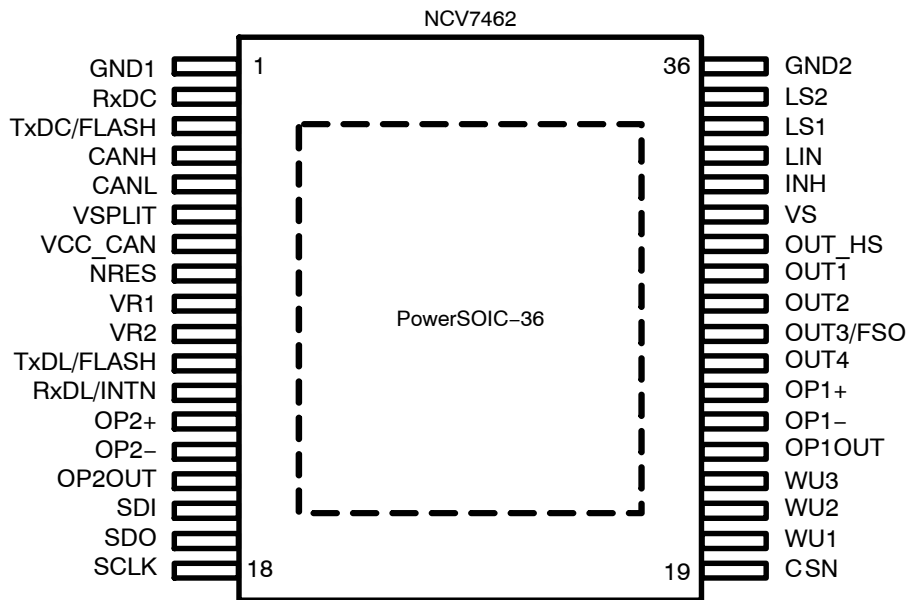

Figure 2. Package Pin-out

Table 1. PIN DESCRIPTION

Pin #	Pin Name	Description	Comment
1	GND1	Ground	Ground connection
2	RxDC	Digital push-pull output	Receiver output of the CAN transceiver
3	TxDC/FLASH	Digital input with pull-up	Transmitter data input of the CAN transceiver / Flash mode entry
4	CANH	CAN bus interface	High-level CAN bus line (high during dominant)
5	CANL	CAN bus interface	Low-level CAN bus line (low during dominant)
6	VSPLIT	HV output	CAN common-mode stabilization pin
7	VCC_CAN	Supply input	Supply for the CAN transceiver
8	NRES	Digital open-drain output with internal pull-up	Reset signal to the MCU
9	VR1	5V regulator output	2%, 250 mA
10	VR2	5V regulator output	2%, 50 mA, protected against short to VS
11	TxDL/FLASH	Digital input with pull-up	Transmitter data input of the LIN transceiver / Flash mode entry
12	RxDL/INTN	Digital push-pull output	Receiver output of the LIN transceiver / Interrupt output
13	OP2+	Analog input	Opamp input
14	OP2-	Analog input	Opamp input
15	OP2OUT	HV analog output	Opamp output
16	SDI	Digital input with pull-down	SPI data input
17	SDO	Digital push-pull output, tristate	SPI data output
18	SCLK	Digital input with pull-down	SPI clock input
19	CSN	Digital input with pull-up	SPI chip select input
20	WU1	HV input	Voltage-sense input (threshold typ. VS/2), switched pull-up/down
21	WU2	HV input	Voltage-sense input (threshold typ. VS/2), switched pull-up/down

NCV7462

Table 1. PIN DESCRIPTION

Pin #	Pin Name	Description	Comment
22	WU3	HV input	Voltage-sense input (threshold typ. $V_S/2$), switched pull-up/down
23	OP1OUT	HV analog output	Opamp output
24	OP1-	Analog input	Opamp input
25	OP1+	Analog input	Opamp input
26	OUT4	HS driver	Resistive loads, R_{on} 7 Ω typ, I_{lim} > 140 mA
27	OUT3/FSO	HS driver	Resistive loads, R_{on} 7 Ω typ, I_{lim} > 140 mA / FSO output
28	OUT2	HS driver	Resistive loads, R_{on} 7 Ω typ, I_{lim} > 140 mA
29	OUT1	HS driver	Resistive loads, R_{on} 2 Ω /7 Ω typ, I_{lim} > 250 mA/140 mA (two configurations)
30	OUT_HS	HS driver	Resistive loads, R_{on} 1 Ω typ, I_{lim} > 1000 mA
31	VS	Battery supply input	Principle power-supply of the device
32	INH	HS output	Battery related output to switch off the LIN master resistor or to control an external voltage regulator
33	LIN	LIN bus interface	LIN bus pin, low in dominant state
34	LS1	LS driver	Relay driver, R_{on} 3 Ω typ, I_{lim} > 250 mA, active clamp to ground
35	LS2	LS driver	Relay driver, R_{on} 3 Ω typ, I_{lim} > 250 mA, active clamp to ground
36	GND2	Ground/test pin	Ground connection in the application / test pin in the production

NCV7462

APPLICATION CIRCUIT

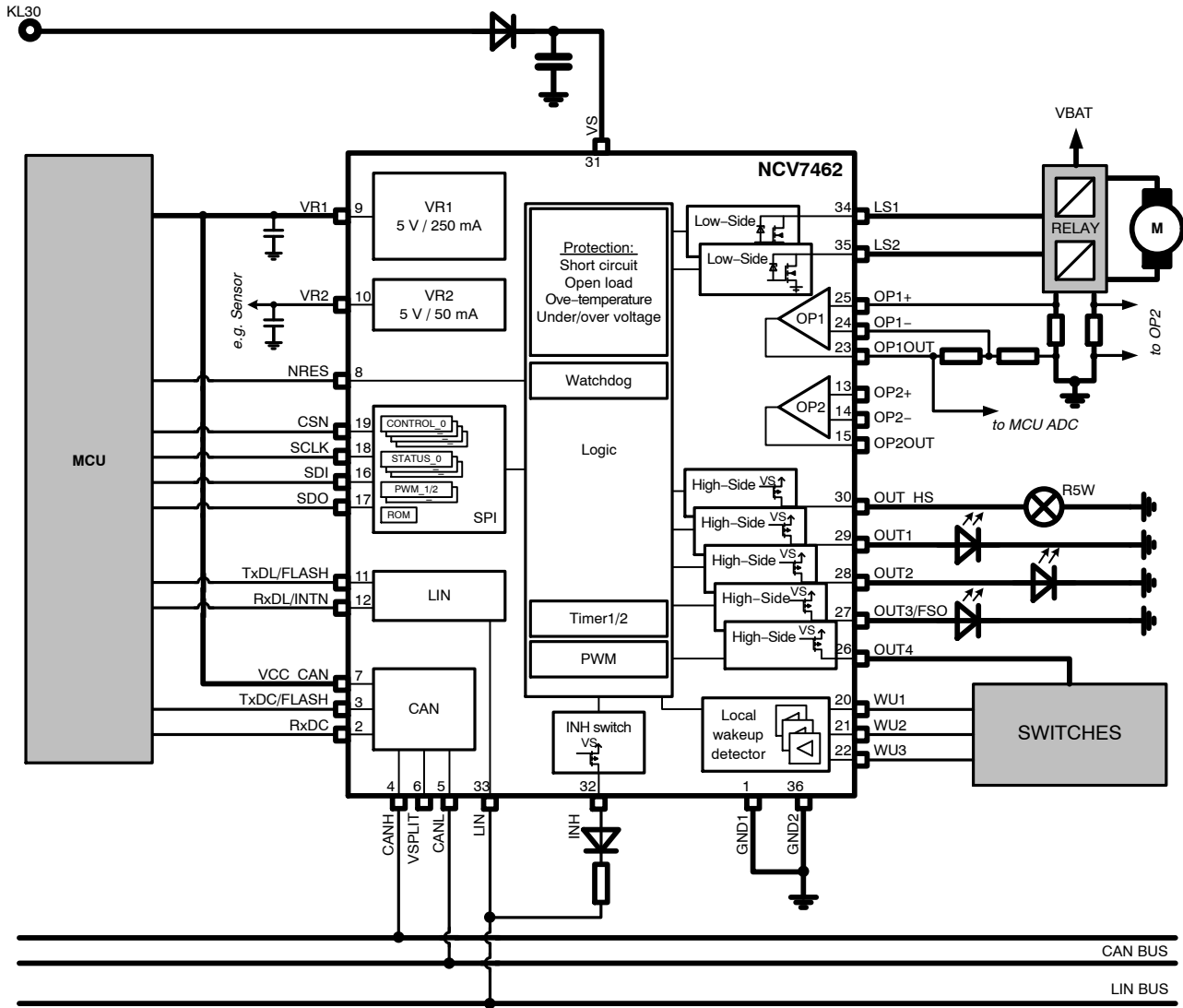

Figure 3. Application Diagram

Table 2. ABSOLUTE MAXIMUM RATINGS

Symbol	Parameter	Min	Max	Unit
Vmax_VS	Power supply voltage	-0.3	40	V
Vmax_WU1-3	Wake pins DC and transient voltage	-0.3	VS + 0.3	V
Vmax_OPOUT1/2	Opamp analog output voltage range	-0.3	VS + 0.3	V
Vmax_OUT1-4 Vmax_OUT_HS	High-side output voltage range	-0.3	VS + 0.3	V
Vmax_LS1/2	LS1/2 pin voltage range DC	-0.3	40	V
	LS1/2 pin transient voltage range (during flyback)	-0.3	65	V
Vmax_LIN	DC voltage on LIN pin	-20	40	V
Vmax_INH	DC voltage on INH pin	-0.3	VS + 0.3	V
Vmax_CANH/L Vmax_VSPLIT	DC voltage on pin CANH, CANL and VSPLIT	-40	40	V
Vmax_VR1	Stabilized supply voltage, logic supply	-0.3	min (5.5, VS + 0.3)	V
Vmax_VR2	Stabilized supply voltage	-0.3	28	V
Vmax_VCC_CAN	Supply input for the CAN transceiver	-0.3	5.5	V
Vmax_digIO	DC voltage at digital pins (RxDC, NRES, RxDL/INTN, SDI, SDO, SCLK, CSN)	-0.3	VR1 + 0.3	V
Vmax_OP1/2(+/-)	Opamp input voltage range	-0.3	VS + 0.3	V
Vmax_TxDL(C)/FLASH	DC voltage at TxDL/FLASH and TxDC/FLASH inputs	-0.3	28	V
Wmax_LS1/2	Maximum clamping energy on LS1/2		36	mJ
Imax_LS1/2	Maximum LS1/2 pin current		500	mA
	Maximum LS1/2 pin current, transient or without VS supply	-120		mA
Imax_input	Current injection into Vs related input pins		5	mA
ESD Human Body Model (100pF, 1500Ω)	All pins	-2	+2	kV
	Pins LIN, CANH/L, VSPLIT and WU1-3 to GND	-4	+4	
	Pins OUT_HS, OUT1-4, LS1/2 to GND	-4	+4	
ESD following IEC 61000-4-2 (150 pF, 330 Ω)	Valid for pins VS, LIN, CANH/L, VSPLIT, WUx, OUT_HS, OUT1-4 - VS pin with reverse-protection and filtering capacitor - VSPLIT pin stressed through split CAN termination - WUx pins stressed through a serial resistor >10 kΩ - OUT_HS, OUT1-4 pins with parallel capacitor 10 nF	-6	+6	kV
ESD Charged Device Model following JESD22-C101/AE C-Q100-011	All pins	-500	+500	V
	Corner pins	-750	+750	V
Tj_mr	Junction temperature	-40	+170	°C
Tstg	Storage Temperature Range	-55	+150	°C
MSL	Moisture Sensitivity Level (max. 260°C processing)	MSL3		

Stresses exceeding those listed in the Maximum Ratings table may damage the device. If any of these limits are exceeded, device functionality should not be assumed, damage may occur and reliability may be affected.

Table 3. RECOMMENDED OPERATING CONDITIONS

Symbol	Parameter	Min	Max	Unit
Vop_VS_par	Power supply voltage for valid parameter specifications	6	18	V
Vop_VS_func	Power supply for correct functional behavior	5	28	V
Vop_WU1-3	Wake DC and transient voltage	0	VS	V
Vop_OPOUT1/2	Opamp analog output voltage range	0	VS	V
Vop_OUT1-4 Vop_OUT_HS	High-side output voltage range	0	VS	V
Vop_LS1/2	LS1/2 pin voltage range DC LS1/2 pin transient voltage range (during flyback)	0 0	VS 65	V V
Vop_LIN Vop_INH	LIN and INH pin voltage range	0	VS	V
Vop_CANH/L Vop_VSPLIT	DC voltage on pin CANH, CANL and VSPLIT	0	VCC_CAN	V
Vop_VR1	Stabilized supply voltage	4.9	5.1	V
Vop_VR2	Stabilized supply voltage	4.9	5.1	V
Vop_VCC_CAN_normal	Supply input for the CAN transceiver for normal operation (transmission and reception)	4.75	5.25	V
Vop_VCC_CAN_lowpower	Supply input for the CAN transceiver for low-power operation (CAN wakeup detection)	0	5.25	V
Vop_digIO	DC voltage at digital pins (RxDC, NRES, RxDL/INTN, SDI, SDO, SCLK, CSN)	0	VR1	V
Vop_OP1/2(+/-)	Opamp input voltage range	-0.2	3	V
Vop_TxDL(C)/FLASH	DC voltage at TxDL/FLASH and TxDC/FLASH inputs	0	18	V
Tj_op	Junction temperature	-40	+150	°C

Functional operation above the stresses listed in the Recommended Operating Ranges is not implied. Extended exposure to stresses beyond the Recommended Operating Ranges limits may affect device reliability.

Table 4. THERMAL CHARACTERISTICS

Symbol	Parameter	Test Condition	Min	Typ	Max	Unit
THERMAL PROTECTION						
Tjw	Thermal warning level		120	130	140	°C
Tjw_hys	Thermal warning hysteresis			5		°C
Tjwd1	Thermal shut-down level 1		130	140	150	°C
Tjwd1_hys	Thermal shut-down 1 hysteresis			5		°C
Tjwd2	Thermal shut-down level 2		140	155	170	°C
Tjwd2_hys	Thermal shut-down 2 hysteresis			5		°C
THERMAL RESISTANCE						
Rth_jc	Thermal resistance junction-to-case			3.5		°C/W
Rth_ja	Thermal resistance junction-to-ambient		see figure below			°C/W

NCV7462

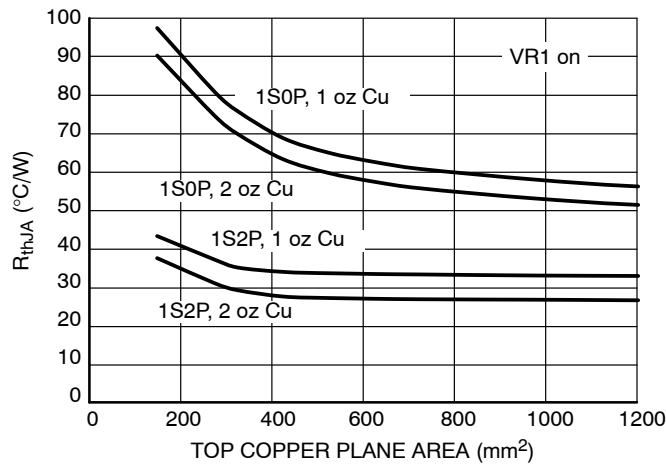

Figure 4. Thermal Resistance Junction-to-Ambient

ELECTRICAL CHARACTERISTICS

($-40^{\circ}\text{C} \leq T_J \leq 150^{\circ}\text{C}$, $6\text{ V} \leq V_S \leq 18\text{ V}$, unless otherwise specified)

Table 5. VS SUPPLY

Symbol	Parameter	Test Condition	Min	Typ	Max	Unit
VS	Supply Voltage	Functional Voltage regulators with deteriorated performance	5		28	V
		Parameter specification	6		18	
VS_POR	VS POR threshold		2.8	3.45	4.1	V
VS_UV	VS UV-threshold voltage		5.11		5.81	V
VS_UV_hyst	Undervoltage hysteresis		0.04	0.1	0.2	V
VS_OV	VS OV-threshold voltage		20		22	V
VS_OV_hyst	Overvoltage hysteresis		0.5	1	1.5	V
I_VS_sleep	VS consumption in sleep mode	Sleep mode VS = 12 V, VR1/2 are off, bus communication off No wake-up request pending, OUTx = floating T _J = 85°C (Note 1)	10	30	60	μA
I_VS_sleep_cs	VS consumption in sleep mode (with cyclic sense)	Sleep mode VS = 12 V, VR1/2 are off, bus communication off T2_PER = 50 ms, T2_TON = 100 μs No wake-up request pending T _J = 85°C (Note 1)	40	70	130	μA
I_VS_stdby	VS consumption in standby mode	Standby mode VS = 12 V, VR1 not loaded, VR2 off VR1 current comparator enabled OUTx = floating Bus communication off, no cyclic sensing No wake-up request pending T _J = 85°C (Note 1)	30	70	80	μA
I_VS_stdby_cs	VS consumption in standby mode (with cyclic sense)	Standby mode VS = 12 V, VR1 not loaded, VR2 off VR1 current comparator enabled T2_PER = 50 ms, T2_TON = 100 μs Bus communication off No wake-up request pending T _J = 85°C (Note 1)		100		μA
I_VS_norm	VS consumption in normal mode	Normal mode VR1/2 are on (unloaded) OUTx = floating, TxD LIN/CAN not active, Opamp outputs not loaded		4.5	10	mA
I_VS_add_VR1	VR1 current consumption from VS	Normal/Standby mode, VR1 loaded		0.011 • I _{out_VR1}		mA
I_VS_add_VR2	VR2 current consumption from VS	VR2 loaded		0.013 • I _{out_VR2}		mA

1. Values based on design and characterization, not tested in production.

NCV7462

ELECTRICAL CHARACTERISTICS

($-40^{\circ}\text{C} \leq T_J \leq 150^{\circ}\text{C}$, $6\text{ V} \leq V_S \leq 18\text{ V}$, unless otherwise specified)

Table 6. VOLTAGE REGULATOR VR1

Symbol	Parameter	Test Condition	Min	Typ	Max	Unit
V_VR1	Regulator output voltage	$0\text{ mA} \leq I(\text{VR1}) \leq 250\text{ mA}$, $6\text{ V} \leq V_S \leq 27\text{ V}$	4.9	5	5.1	V
Iout_VR1	Regulator output current				-250	mA
Ilim_VR1	Regulator current limitation		-1000	-800	-400	mA
Vdrop_VR1	Dropout voltage	$I(\text{VR1}) = 100\text{ mA}$, $V_S = 5\text{ V}$		0.25	0.4	V
		$I(\text{VR1}) = 100\text{ mA}$, $V_S = 4.5\text{ V}$		0.3	0.5	
		$I(\text{VR1}) = 50\text{ mA}$, $V_S = 4.5\text{ V}$		0.2	0.4	
Loadreg_VR1	Load regulation	$1\text{ mA} \leq I(\text{VR1}) \leq 50\text{ mA}$	-30	10	30	mV
Linereg_VR1	Line regulation	$I(\text{VR1}) \leq 5\text{ mA}$ $6\text{ V} \leq V_S \leq 18\text{ V}$	-30	10	30	mV
Ttsd_VR1	VR1 deactivation time after thermal shutdown 2		0.85	1	1.15	s
Cload_VR1	VR1 load capacitor	ESR < 200 m Ω , ceramic recommended	1	2.2		μF
Icmp_VR1_rise	Current comp. rising threshold	VR1 consumption increasing	0.7	1.7	3	mA
Icmp_VR1_fall	Current comp. falling threshold	VR1 consumption decreasing $T_J = -40 - 130^{\circ}\text{C}$	0.5	1.1	2	mA
Icmp_VR1_hys	Current comp. hysteresis			0.5		mA
Vfail_VR1	VR1 fail threshold	VR1 forced	1.7	2	2.4	V
Tfail_VR1	VR1 fail blanking time			5	10	μs
Tshort_VR1	VR1 short blanking time		3.4	4	4.6	ms

Table 7. VOLTAGE REGULATOR VR2

Symbol	Parameter	Test Condition	Min	Typ	Max	Unit
V_VR2	Output voltage tolerance	$0\text{ mA} \leq I(\text{VR1}) \leq 50\text{ mA}$ $6\text{ V} \leq V_S \leq 18\text{ V}$	4.9	5	5.1	V
Iout_VR2	Output current				-50	mA
Ilim_VR2	Short circuit output current		-200	-110	-80	mA
Vdrop_VR2	Dropout voltage	$I(\text{VR1}) = 30\text{ mA}$, $V_S = 5\text{ V}$		0.3	0.4	V
Loadreg_VR2	Load regulation	$1\text{ mA} \leq I(\text{VR1}) \leq 50\text{ mA}$	-30	10	30	mV
Linereg_VR2	Line regulation	$I(\text{VR1}) \leq 5\text{ mA}$ $6\text{ V} \leq V_S \leq 18\text{ V}$	-30	10	30	mV
Cload_VR2	Load capacitor	ESR < 200 m Ω , ceramic recommended	0.22	1		μF
Vfail_VR2	VR2 fail threshold	VR2 forced	1.7	2	2.4	V
Tfail_VR2	VR2 fail blanking time			2	10	μs
Tshort_VR2	VR2 short blanking time		3.4	4	4.6	ms

Product parametric performance is indicated in the Electrical Characteristics for the listed test conditions, unless otherwise noted. Product performance may not be indicated by the Electrical Characteristics if operated under different conditions.

NCV7462

ELECTRICAL CHARACTERISTICS

($-40^{\circ}\text{C} \leq T_J \leq 150^{\circ}\text{C}$, $6\text{ V} \leq V_S \leq 18\text{ V}$, unless otherwise specified)

Table 8. VR1 UNDER-VOLTAGE DETECTOR

Symbol	Parameter	Test Condition	Min	Typ	Max	Unit
VR1_RES1	VR1 Reset threshold 1 (default)	SPI VR1_RES.x = 00	4.33	4.5	4.67	V
VR1_RES2	VR1 Reset threshold 2	SPI VR1_RES.x = 01	4.135	4.3	4.465	V
VR1_RES3	VR1 Reset threshold 3	SPI VR1_RES.x = 10	3.69	3.9	4.16	V
VR1_RES4	VR1 Reset threshold 4	SPI VR1_RES.x = 11	3.44	3.7	3.91	V
Tdel_VR1_RES	Reaction delay between VR1 undervoltage and NRES low pulse		6		40	μs
Tflt_VR1_RES	VR1 undervoltage filter time			16		μs
T_NRES	NRES pulse length after VR1 undervoltage release		1.7	2	2.3	ms

Table 9. VCC_CAN SUPPLY INPUT

Symbol	Parameter	Test Condition	Min	Typ	Max	Unit
IVCAN_norm_rec	Consumption from VCC_CAN pin	CAN enabled; normal mode; recessive transmitted $4.75\text{ V} < V_{CC_CAN} < 5.25\text{ V}$			10	mA
IVCAN_norm_dom		CAN enabled; normal mode; dominant transmitted $4.75\text{ V} < V_{CC_CAN} < 5.25\text{ V}$ bus termination $60\ \Omega$			75	mA
IVCAN_lowpower		CAN wakeup detector active (supplied from VS); standby or sleep mode; no wakeup detected; $0\text{ V} < V_{CC_CAN} < 5.25\text{ V}$; $T_J = 85^{\circ}\text{C}$ (Note 2)			6	μA
Vfail_VCAN	VCAN undervoltage threshold		4	4.3	4.65	V
Vfail_hyst_VCAN	VCC_CAN hysteresis	normal mode		100		mV
Tfail_VCAN	VCAN fail blanking time			2	10	μs

2. Values based on design and characterization, not tested in production.

NCV7462

ELECTRICAL CHARACTERISTICS

($-40^{\circ}\text{C} \leq T_J \leq 150^{\circ}\text{C}$, $6\text{ V} \leq V_S \leq 18\text{ V}$, unless otherwise specified)

Table 10. HIGH-SIDE OUTPUTS (OUT1-4)

Symbol	Parameter	Test Condition	Min	Typ	Max	Unit
Ron_OUT1_low	On-resistance to VS, OUT1 in "low-ohmic" configuration	$T_J = 25^{\circ}\text{C}$, $I(\text{OUT1}) = -100\text{ mA}$		2		Ω
		$T_J = 125^{\circ}\text{C}$			3.3	Ω
Ron_OUT1_high	On-resistance to VS, OUT1 in "normal-ohmic" configuration	$T_J = 25^{\circ}\text{C}$, $I(\text{OUT1}) = -60\text{ mA}$		7		Ω
		$T_J = 125^{\circ}\text{C}$			13	Ω
Ron_OUT2-4	On-resistance to VS	$T_J = 25^{\circ}\text{C}$, $I(\text{OUT2-4}) = -60\text{ mA}$		7		Ω
		$T_J = 125^{\circ}\text{C}$			13	Ω
llim_OUT1_low	Output current limitation to ground, OUT1 in "low-ohmic" configuration	$V(\text{OUT1}) = 0\text{ V}$	-500	-375	-250	mA
llim_OUT1_high	Output current limitation to ground, OUT1 in "normal-ohmic" configuration	$V(\text{OUT1}) = 0\text{ V}$	-330	-235	-140	mA
llim_OUT2-4	Output current limitation to ground	$V(\text{OUT2-4}) = 0\text{ V}$	-330	-235	-140	mA
luld_OUT1_low	OUT1 underload threshold, OUT1 in "low-ohmic" configuration		-30	-16	-4	mA
luld_OUT1_high	OUT1 underload threshold, OUT1 in "normal-ohmic" configuration		-6.5	-3.5	-0.8	mA
luld_OUT2-4	OUT2-4 underload threshold		-6.5	-3.5	-0.8	mA
lleak_OUT1-4_norm	Output leakage current, normal mode	$V_S = 28\text{ V}$ $V(\text{OUT1-4}) = 0\text{ V}$	-3			μA
lleak_OUT1-4_stdby	Output leakage current, standby or sleep mode	$V_S = 28\text{ V}$ $V(\text{OUT1-4}) = 0\text{ V}$	-3			μA
Slew_OUT1_low	Slew rate of OUT1, OUT1 in "low-ohmic" configuration	$V_S = 13.2\text{ V}$ 250 mA resistive load	0.2	0.5	0.8	$\text{V}/\mu\text{s}$
Slew_OUT1_high	Slew rate of OUT1, OUT1 in "normal-ohmic" configuration	$V_S = 13.2\text{ V}$ 140 mA resistive load	0.2	0.5	0.8	$\text{V}/\mu\text{s}$
Slew_OUT2-4	Slew rate of OUT2-4	$V_S = 13.2\text{ V}$ 140 mA resistive load	0.2	0.5	0.8	$\text{V}/\mu\text{s}$
Tblank_ULD_OUT1-4	Underload detection blanking delay	After OUT1-4 activation	65	80	95	μs
Tfilt_ULD_OUT1-4	Underload detection filter time		50	60	75	μs
Tfilt_OLD_OUT1-4	Overload shutdown filter time		50	60	75	μs

NCV7462

ELECTRICAL CHARACTERISTICS

($-40^{\circ}\text{C} \leq T_J \leq 150^{\circ}\text{C}$, $6\text{ V} \leq V_S \leq 18\text{ V}$, unless otherwise specified)

Table 11. HIGH-SIDE OUTPUT (OUT_HS)

Symbol	Parameter	Test Condition	Min	Typ	Max	Unit
Ron_OUT_HS	On-resistance to VS	$T_J = 25^{\circ}\text{C}$, $I(\text{OUT_HS}) = -150\text{ mA}$		1	1.5	Ω
		$T_J = 125^{\circ}\text{C}$		1.6	3	Ω
Ilim_OUT_HS	Output current limitation to ground	$V(\text{OUT_HS}) = 0\text{ V}$	-1900	-1500	-1000	mA
Iuld_OUT_HS	Underload detection threshold		-120	-80	-40	mA
Ileak_OUT_HS_norm	Output leakage current, normal mode	$V(\text{OUT_HS}) = 0\text{ V}$	-3			μA
Ileak_OUT_HS_stdby	Output leakage current, standby or sleep mode	$V(\text{OUT_HS}) = 0\text{ V}$	-3			μA
Slew_OUT_HS	Slew rate of OUT_HS	$V_S = 13.2\text{ V}$ Resistive load 480 mA	0.2	0.5	0.8	$\text{V}/\mu\text{s}$
Tblank_ULD_OUT_HS	Underload detection blanking delay	After OUT_HS activation	65	80	95	μs
Tfilt_ULD_OUT_HS	Underload detection filter time		50	60	75	μs
Tfilt_OLD_OUT_HS	Overload shutdown filter time		102	120	138	μs
Tfit_OCR	Over-current recovery filter time		340	400	460	μs

Table 12. LOW-SIDE RELAY OUTPUT (LS1/2)

Symbol	Parameter	Test Condition	Min	Typ	Max	Unit
Ron_LS1/2	On-resistance to ground	$T_J = 25^{\circ}\text{C}$, $I(\text{LS1/2}) = 100\text{ mA}$			3.3	Ω
Ilim_LS1/2	Output current limitation	$\text{LS1/2} = V_S$	250	340	500	mA
Vclamp_LS1/2	Output clamp voltage	$I(\text{LS1/2}) = 100\text{ mA}$	50		65	V
Ileak_LS1/2_norm	Output leakage current, normal mode	$\text{LS1/2} = V_S = 16\text{ V}$			3	μA
Ileak_LS1/2_stdby	Output leakage current, standby or sleep mode	$\text{LS1/2} = V_S = 16\text{ V}$			3	μA
Slew_LS1/2	Slew rate of LS1/2	$V_S = 13.2\text{ V}$	0.2	2	4	$\text{V}/\mu\text{s}$
Tfilt_OLD_LS1/2	Overload shutdown filter time		50	60	75	μs

NCV7462

ELECTRICAL CHARACTERISTICS

($-40^{\circ}\text{C} \leq T_J \leq 150^{\circ}\text{C}$, $6\text{ V} \leq V_S \leq 18\text{ V}$, unless otherwise specified)

Table 13. INH HIGH-SIDE SWITCH

Symbol	Parameter	Test Condition	Min	Typ	Max	Unit
V_INH_DROP	High-level voltage drop	I(INH) = -15 mA	0.1	0.35	0.75	V
I_INH_LEAK	Leakage current		-1		1	μA
I_INH_LIM	Current limitation		-230		-45	mA

Table 14. WAKE-UP (WU1-3)

Symbol	Parameter	Test Condition	Min	Typ	Max	Unit
Vth_down_WU1-3	Wake-up negative edge threshold voltage	WU1-3 configurable as Source/Sink via SPI	0.4 VS	0.5 VS	0.6 VS	V
Vth_up_WU1-3	Wake-up positive edge threshold voltage	WU1-3 configurable as Source/Sink via SPI	0.4 VS	0.5 VS	0.6 VS	V
Vhyst_WU1-3	Wake-up threshold hysteresis		100	300	500	mV
Ipullup_WU1-3	Pullup current	$1.5\text{ V} < V(\text{WU1-3}) < (V_S - 3\text{ V})$	-30	-20	-10	μA
Ipulldown_WU1-3	Pulldown current	$1.5\text{ V} < V(\text{WU1-3}) < (V_S - 3\text{ V})$	10	20	30	μA
Twu_WU1-3	Minimum time for wake-up		51	64	77	μs

Table 15. CURRENT AMPLIFIER OP1/2

Symbol	Parameter	Test Condition	Min	Typ	Max	Unit
GBW_OP	GBW product		1	3.5	7	MHz
AV_DC_OP	DC open loop gain		80			dB
PSRR_OP	Power supply rejection	DC, $V_{in} = 150\text{ mV}$	80			dB
Voff_OP	Input offset voltage		-6		6	mV
Vicr_OP	Common mode input range		-0.2	0	3	V
Voh_OP	Output voltage range high	I(OPOUT1/2) = -1 mA	VS - 0.2		VS	V
Vol_OP	Output voltage range low	I(OPOUT1/2) = +1 mA	0		0.2	V
Ilimp_OPOUT1/2	Output current limitation+	DC	5	10	15	mA
Ilimn_OPOUT1/2	Output current limitation-	DC	-15	-10	-5	mA
Slewp_OP	Slew rate positive		1	4	10	V/ μs
Slewn_OP	Slew rate negative		-10	-4	-1	V/ μs
Tsat_rec	Output recovery time from saturation at V_S or GND				4	μs

NCV7462

ELECTRICAL CHARACTERISTICS

($-40^{\circ}\text{C} \leq T_J \leq 150^{\circ}\text{C}$, $6\text{ V} \leq V_S \leq 18\text{ V}$, unless otherwise specified)

Table 16. MODE TRANSITION TIMING

Symbol	Parameter	Test Condition	Min	Typ	Max	Unit
Tdel_powerup	Transition from power-up to Init	VS reaching VS_POR to VR1 startup			2.5	ms
Tdel_norm_stdby	Transition time from normal to standby mode via SPI				300	μs
Tdel_norm_sleep	Transition time from normal to sleep mode via SPI				750	μs
Tdel_stdby_norm	Delay of INTN pulse in standby after wakeup				300	μs
Tdel_sleep_norm	Transition from sleep to normal mode via wakeup				300	μs
Tdel_norm_flash	Transition time from normal to flash mode via TxDL(C)/FLASH				300	μs
Tdel_stdby_flash	Transition time from standby to flash mode via TxDL(C)/FLASH				300	μs
Tdel_sleep_flash	Transition time from sleep to flash mode via TxDL(C)/FLASH				750	μs
Tdel_flash_norm	Transition from flash to normal mode via TxDL(C)/FLASH				450	μs

Table 17. NRES AND INTN SIGNAL TIMING

Symbol	Parameter	Test Condition	Min	Typ	Max	Unit
T_NRES	NRES low pulse duration, e.g. after a watchdog failure		1.7	2	2.3	ms
T_INTN	INTN low pulse duration after a wake-up event		106	125	144	μs

Table 18. INTERNAL PWM AND TIMERS

Symbol	Parameter	Test Condition	Min	Typ	Max	Unit
f_PWM_lo	PWM controller frequency, Low setting (default)	FSEL_OUTx/LSx = 0	127	150	173	Hz
f_PWM_hi	PWM controller frequency, High setting	FSEL_OUTx/LSx = 1	170	200	230	Hz
Ttim_acc	Timer1/2 period/on-time accuracy (see CONTROL_2 register settings)	T1_TPER.[2:0], T1_TON, T2_TPER.[2:0], T2_TON.[1:0]	-15		+15	%

NCV7462

ELECTRICAL CHARACTERISTICS

($-40^{\circ}\text{C} \leq T_J \leq 150^{\circ}\text{C}$, $6\text{ V} \leq V_S \leq 18\text{ V}$, unless otherwise specified)

Table 19. DRIVERS/VR2 TIMING

Symbol	Parameter	Test Condition	Min	Typ	Max	Unit
Tdel_OUT_HS_on	Activation delay of OUT_HS driver (from CSN rising edge)	$V(\text{OUT_HS}) > 0.2 \cdot V_S$			60	μs
Tdel_OUT_HS_off	De-activation delay of OUT_HS driver (from CSN rising edge)	$V(\text{OUT_HS}) < 0.8 \cdot V_S$			60	μs
Tdel_OUT1-4_on	Activation delay of OUT1-4 driver (from CSN rising edge)	$V(\text{OUT1-4}) > 0.2 \cdot V_S$			60	μs
Tdel_OUT1-4_off	De-activation delay of OUT1-4 driver (from CSN rising edge)	$V(\text{OUT1-4}) < 0.8 \cdot V_S$			60	μs
Tdel_LS1/2_on	Activation delay of LS1/2 driver (from CSN rising edge)	$V(\text{LS1/2}) < 0.8 \cdot V_S$			100	μs
Tdel_LS1/2_off	De-activation delay of LS1/2 driver (from CSN rising edge)	$V(\text{LS1/2}) > 0.2 \cdot V_S$			100	μs
Tdel_VR2_on	Activation delay of VR2 (from CSN rising edge)	$I(\text{VR2}) = 50\text{ mA}$ $V(\text{VR2}) > 4\text{ V}$		270		μs
Tdel_VR2_off	De-activation delay of VR2 (from CSN rising edge)	$I(\text{VR2}) = 50\text{ mA}$ $V(\text{VR2}) < 4\text{ V}$		200		μs

ELECTRICAL CHARACTERISTICS

($-40^{\circ}\text{C} \leq T_J \leq 150^{\circ}\text{C}$, $6\text{ V} \leq V_s \leq 18\text{ V}$, unless otherwise specified)

Table 20. SPI TIMING

Symbol	Parameter	Test Condition	Min	Typ	Max	Unit
tCSN_SCLK	First SPI clock edge after CSN active	(Note 3)	100			ns
tCSN_SDO	SDO output stable after CSN active	(Note 3)			80	ns
tCSN_High	Inter-frame space (CSN inactive)	(Note 3)	14			μs
tSCLK_High	Duration of SPI clock High level	(Note 3)	250			ns
tSCLK_Low	Duration of SPI clock Low level	(Note 3)	250			ns
tSCLK_per	SPI clock period	(Note 3)	1			μs
tSDI_set	Setup time of SDI input towards SPI clock	(Note 3)	100			ns
tSDI_hold	Hold time of SDI input towards SPI clock	(Note 3)	100			ns
tSCLK_SDO	SDO output stable after SPI clock falling edge	(Note 3)			250	ns

3. Values based on design and characterization, not tested in production.

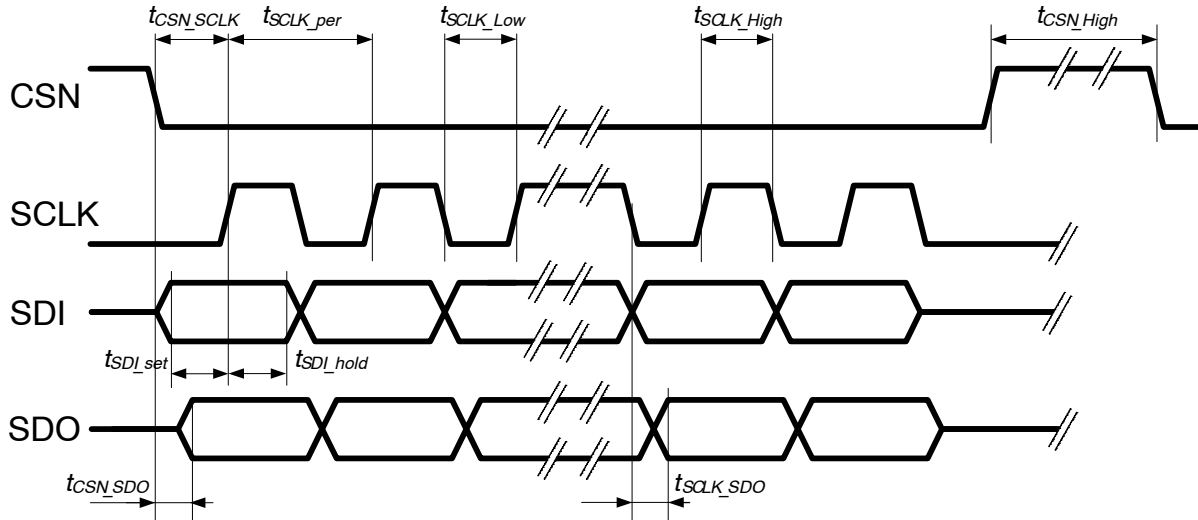

Figure 5. SPI Timing Parameters

NCV7462

ELECTRICAL CHARACTERISTICS

($-40^{\circ}\text{C} \leq T_J \leq 150^{\circ}\text{C}$, $6\text{ V} \leq V_S \leq 18\text{ V}$, unless otherwise specified)

Table 21. WINDOW WATCHDOG

Symbol	Parameter	Test Condition	Min	Typ	Max	Unit
Twd_acc	Watchdog timing accuracy		-25		25	%
T_wd_TO	Timeout watchdog period; (watchdog is in the timeout mode after NRES release)		48.75	65	81.25	ms
T_wd_CW	Window watchdog closed window	SPI WD_PER.x = 00		6		ms
		SPI WD_PER.x = 01		24		
		SPI WD_PER.x = 10		60		
		SPI WD_PER.x = 11		120		
T_wd_OW	Window watchdog open window	SPI WD_PER.x = 00		10		ms
		SPI WD_PER.x = 01		40		
		SPI WD_PER.x = 10		100		
		SPI WD_PER.x = 11		200		
T_wd_trig	Window watchdog trigger period via SPI (the safe trigger area)	SPI WD_PER.x = 00	7.5	9.75	12	ms
		SPI WD_PER.x = 01	30	39	48	
		SPI WD_PER.x = 10	75	97.5	120	
		SPI WD_PER.x = 11	150	195	240	
T_wd_33_TO	WD_STATUS.0 bit threshold of timeout length (in timeout mode)			31.5		%
T_wd_66_TO	WD_STATUS.1 bit threshold of timeout length (in timeout mode)			63		%
T_wd_33_OW	WD_STATUS.0 bit threshold of open window length (in open window mode)	SPI WD_PER.x = 00		26.5		%
		SPI WD_PER.x = 01		32		
		SPI WD_PER.x = 10		33.3		
		SPI WD_PER.x = 11		33.3		
T_wd_66_OW	WD_STATUS.1 bit threshold of open window length (in open window mode)	SPI WD_PER.x = 00		63		%
		SPI WD_PER.x = 01		76.8		
		SPI WD_PER.x = 10		66.6		
		SPI WD_PER.x = 11		66.6		

NCV7462

ELECTRICAL CHARACTERISTICS

($-40^{\circ}\text{C} \leq T_J \leq 150^{\circ}\text{C}$, $5\text{ V} \leq V_S \leq 28\text{ V}$, Normal mode, unless otherwise specified); the following bus loads are considered: L1 = 1 k Ω / 1 nF; L2 = 660 Ω / 6.8 nF; L3 = 500 Ω / 10 nF.

Table 22. LIN TRANSMITTER DC CHARACTERISTICS

Symbol	Parameter	Test condition	Min	Typ	Max	Unit
VLin_dom_LoSup	LIN dominant output voltage	TxDL = low; VS = 7.3 V, L1			1.2	V
VLin_dom_HiSup	LIN dominant output voltage	TxDL = low; VS = 18 V, L1			2	V
VLin_rec	LIN recessive output voltage	TxDL = high I(LIN) = 0 mA	VS - 1.2			V
ILIN_lim	LIN short circuit current limitation	V(LIN) = 18 V	40		200	mA
Rslave_LIN	Internal pull-up resistance		20	33	47	k Ω

Table 23. LIN RECEIVER DC CHARACTERISTICS

Symbol	Parameter	Test condition	Min	Typ	Max	Unit
Vbus_dom_LIN	Bus voltage for dominant state				0.4	VS
Vbus_rec_LIN	Bus voltage for recessive state		0.6			VS
Vrec_dom_LIN	Receiver threshold	LIN bus recessive \rightarrow dominant	0.4		0.5	VS
Vrec_rec_LIN	Receiver threshold	LIN bus dominant \rightarrow recessive	0.5		0.6	VS
Vrec_cnt_LIN	Receiver threshold centre voltage	$(V_{rec_rec_LIN} + V_{rec_dom_LIN}) / 2$	0.475		0.525	VS
Vrec_hys_LIN	Receiver hysteresis	$(V_{rec_rec_LIN} - V_{rec_dom_LIN})$	0.05		0.175	VS
Vrec_rec_slp_LIN	LIN wake receiver threshold	Sleep or standby mode	VS - 3.3		VS - 1.1	V
ILIN_off_dom	LIN output current, bus in dominant state	Normal mode, driver off; VS = 12 V; V(LIN) = 0 V	-1			mA
ILIN_off_dom_slp	LIN output current, bus in dominant state	Sleep mode, driver off; VS = 12 V; V(LIN) = 0 V	-20	-15	-2	μA
ILIN_off_rec	LIN output current, bus in recessive state	Driver off; VS < 18 V; VS < V(LIN) < 18 V			20	μA
ILIN_no_GND	LIN current with missing GND	VS = GND = 12 V; 0 < V(LIN) < 18 V	-1		1	mA
ILIN_no_VS	LIN current with missing VS	VS = GND = 0 V; 0 < V(LIN) < 18 V			100	μA

NCV7462

ELECTRICAL CHARACTERISTICS

($-40^{\circ}\text{C} \leq T_J \leq 150^{\circ}\text{C}$, $5\text{ V} \leq V_S \leq 28\text{ V}$, Normal Mode, unless otherwise specified); the following bus loads are considered: L1 = 1 k Ω / 1 nF; L2 = 660 Ω / 6.8 nF; L3 = 500 Ω / 10 nF.

Table 24. LIN TRANSMITTER DYNAMIC CHARACTERISTICS

Symbol	Parameter	Test condition	Min	Typ	Max	Unit
D1	Duty Cycle 1 = $t_{\text{BUS_REC(min)}} / (2 \times \text{TBit})$	THREC(max) = 0.744 x VS THDOM(max) = 0.581 x VS TBIT = 50 μs VS = 7 V to 18 V	0.396		0.5	–
D2	Duty Cycle 2 = $t_{\text{BUS_REC(max)}} / (2 \times \text{TBit})$	THREC(min) = 0.422 x VS THDOM(min) = 0.284 x VS TBIT = 50 μs VS = 7.6 V to 18 V	0.5		0.581	–
D3	Duty Cycle 3 = $t_{\text{BUS_REC(min)}} / (2 \times \text{TBit})$	THREC(max) = 0.788 x VS THDOM(max) = 0.616 x VS TBIT = 96 μs VS = 7 V to 18 V	0.417		0.5	–
D4	Duty Cycle 4 = $t_{\text{BUS_REC(max)}} / (2 \times \text{TBit})$	THREC(min) = 0.389 x VS THDOM(min) = 0.251 x VS TBIT = 96 μs VS = 7.6 V to 18 V	0.5		0.59	–
T_fall_LIN	LIN falling edge	VS = 12 V; L1, L2; Normal slope mode			22.5	μs
T_rise_LIN	LIN rising edge	VS = 12 V; L1, L2; Normal slope mode			22.5	μs
T_sym_LIN	LIN slope symmetry	VS = 12 V; L1, L2; Normal slope mode	–4	0	4	μs
T_fall_norm_LIN	LIN falling edge	VS = 12 V; L3; Normal slope mode			27	μs
T_rise_norm_LIN	LIN rising edge	VS = 12 V; L3; Normal slope mode			27	μs
T_sym_norm_LIN	LIN slope symmetry	VS = 12 V; L3; Normal slope mode	–5	0	5	μs
T_fall_low_LIN	LIN falling edge	VS = 12 V; L3; Low slope mode			62	μs
T_rise_low_LIN	LIN rising edge	VS = 12 V; L3; Low slope mode			62	μs
T_TxDL_timeout	TxDL dominant time-out Selected by SPI bits TxDL_TO	SPI setting "00"	27	55	70	ms
		SPI setting "01"	6	13	20	
		SPI setting "1X"	disabled			
C_LIN	Capacitance of the LIN pin	Guaranteed by design; not tested in production		15	25	pF

ELECTRICAL CHARACTERISTICS

($-40^{\circ}\text{C} \leq T_J \leq 150^{\circ}\text{C}$, $5\text{ V} \leq V_s \leq 28\text{ V}$, Normal mode, unless otherwise specified); the following bus loads are considered: L1 = 1 k Ω / 1 nF; L2 = 660 Ω / 6.8 nF; L3 = 500 Ω / 10 nF.

Table 25. LIN RECEIVER DYNAMIC CHARACTERISTICS

Symbol	Parameter	Test condition	Min	Typ	Max	Unit
Trec_prop_down	Propagation delay of receiver falling edge				6	μs
Trec_prop_up	Propagation delay of receiver rising edge				6	μs
Trec_sym	Propagation delay symmetry	Trec_prop_down – Trec_prop_up	-2		2	μs
T_LIN_wake	Dominant duration for wakeup		30	90	150	μs

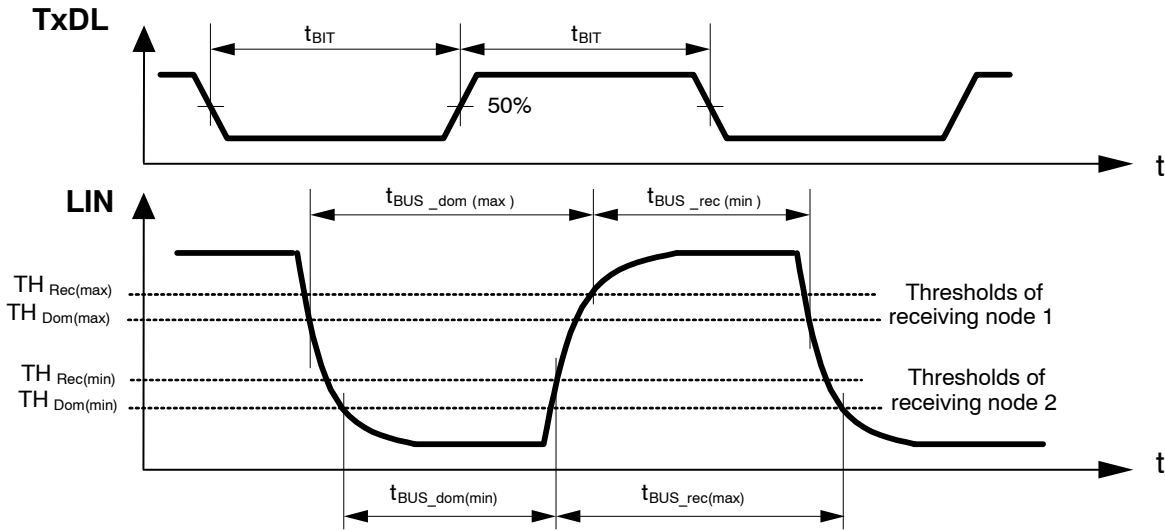

Figure 6. LIN Dynamic Characteristics – Duty Cycles

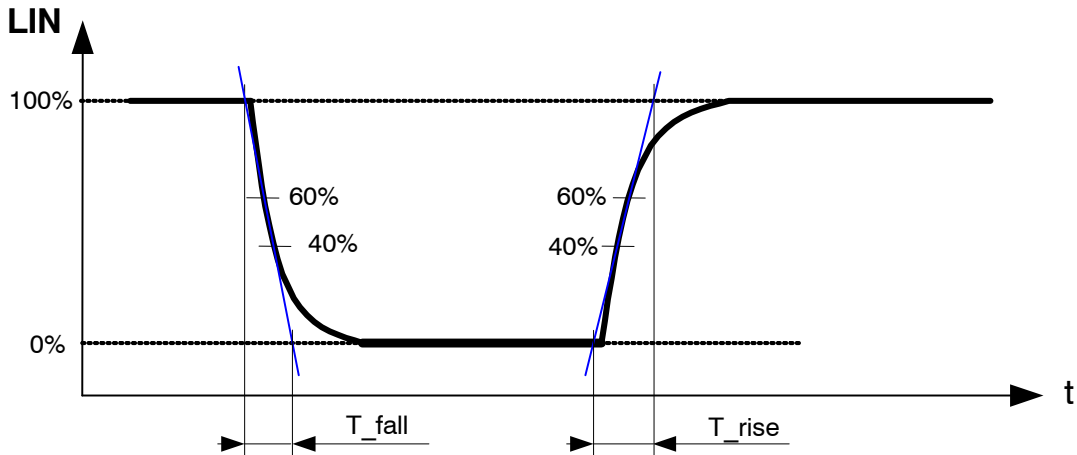

Figure 7. LIN Dynamic Characteristics – Transmitter Slope

ELECTRICAL CHARACTERISTICS

($-40^{\circ}\text{C} \leq T_J \leq 150^{\circ}\text{C}$, $5\text{ V} \leq V_S \leq 28\text{ V}$, Normal mode, unless otherwise specified); the following bus loads are considered: L1 = 1 k Ω / 1 nF; L2 = 660 Ω / 6.8 nF; L3 = 500 Ω / 10 nF.

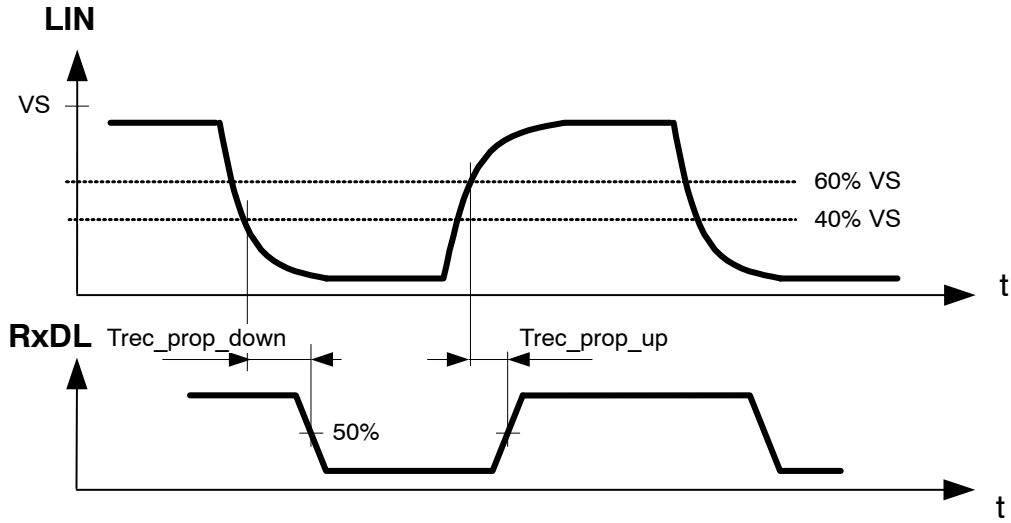

Figure 8. LIN Dynamic Characteristics – Receiver

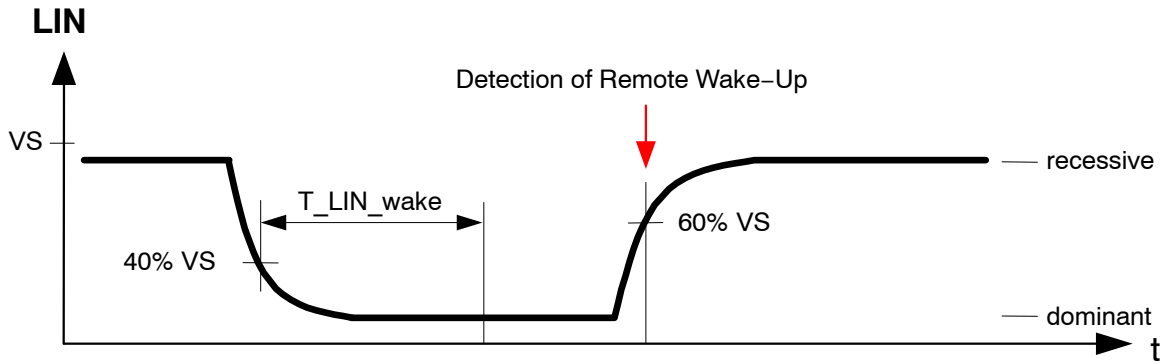

Figure 9. LIN Wakeup

ELECTRICAL CHARACTERISTICS

(-40°C ≤ T_J ≤ 150°C, 6 V ≤ V_S ≤ 18 V, Normal mode, unless otherwise specified)

Table 26. CAN TRANSMITTER DC CHARACTERISTICS

Symbol	Parameter	Test condition	Min	Typ	Max	Unit
V _{o(reces)} (CANH)	Recessive bus voltage at pin CANH	V(TxDC) = VR1 no load, transmitter on	2	2.5	3	V
V _{o(reces)} (CANH)	Recessive bus voltage at pin CANH	no load, transmitter off	-0.1	0	0.1	V
V _{o(reces)} (CANL)	Recessive bus voltage at pin CANL	V(TxDC) = VR1 no load, transmitter on	2	2.5	3	V
V _{o(reces)} (CANL)	Recessive bus voltage at pin CANL	no load, transmitter off	-0.1	0	0.1	V
I _{o(reces)} (CANH)	Recessive output current at pin CANH	-35 V < V(CANH) < 35 V 0 V < VCC_CAN < 5.25 V	-2.5		2.5	mA
I _{o(reces)} (CANL)	Recessive output current at pin CANL	-35 V < V(CANL) < 35 V 0 V < VCC_CAN < 5.25 V	-2.5		2.5	mA
V _{o(dom)} (CANH)	Dominant output voltage at pin CANH	V(TxDC) = 0 V 42.5 Ω < R _L < 60 Ω	3	3.6	4.25	V
V _{o(dom)} (CANL)	Dominant output voltage at pin CANL	V(TxDC) = 0 V 42.5 Ω < R _L < 60 Ω	0.5	1.4	1.75	V
V _{o(dif)} (bus_dom)	Differential bus output voltage (V _{CANH} - V _{CANL})	V(TxDC) = 0 V 42.5 Ω < R _L < 60 Ω	1.5	2.25	3	V
V _{o(dif)} (bus_rec)	Differential bus output voltage (V _{CANH} - V _{CANL})	V(TxDC) = VR1 recessive, no load	-120	0	50	mV
I _{o(SC)} (CANH)	Short-circuit output current at pin CANH	V(CANH) = 0 V, V(TxDC) = 0 V	-120	-80	-45	mA
I _{o(SC)} (CANL)	Short-circuit output current at pin CANL	V(CANL) = 36 V, V(TxDC) = 0 V	45	80	120	mA

ELECTRICAL CHARACTERISTICS

($-40^{\circ}\text{C} \leq T_J \leq 150^{\circ}\text{C}$, $6\text{ V} \leq V_S \leq 18\text{ V}$, Normal mode, unless otherwise specified)

Table 27. CAN RECEIVER DC CHARACTERISTICS

Symbol	Parameter	Test condition	Min	Typ	Max	Unit
$V_i(\text{dif})(\text{th})$	Differential receiver threshold voltage	$-5\text{ V} < V(\text{CANH}) < 12\text{ V}$ $-5\text{ V} < V(\text{CANL}) < 12\text{ V}$	0.5	0.7	0.9	V
$V_{ihcm}(\text{dif})(\text{th})$	Differential receiver threshold voltage for high common mode	$-35\text{ V} < V(\text{CANH}) < 35\text{ V}$ $-35\text{ V} < V(\text{CANL}) < 35\text{ V}$	0.4	0.7	1	V
$R_i(\text{cm})\text{CANH}$	Common mode input resistance at pin CANH		15	26	37	$\text{k}\Omega$
$R_i(\text{cm})\text{CANL}$	Common mode input resistance at pin CANL		15	26	37	$\text{k}\Omega$
$R_i(\text{cm})(\text{m})$	Matching between pin CANH and pin CANL common mode input resistance	$V(\text{CANH}) = V(\text{CANL})$	-3	0	3	%
$R_i(\text{dif})$	Differential input resistance		25	50	75	$\text{k}\Omega$
$C_i(\text{CANH})$	Input capacitance at pin CANH	$V(\text{TxDC}) = V_{CC_CAN}$ not tested in production		7.5	20	pF
$C_i(\text{CANL})$	Input capacitance at pin CANL	$V(\text{TxDC}) = V_{CC_CAN}$ not tested in production		7.5	20	pF
$C_i(\text{dif})$	Differential input capacitance	$V(\text{TxDC}) = V_{CC_CAN}$ not tested in production		3.75	10	pF
ILI	Input leakage current at pin CANH and CANL	$V_{CC_CAN} = 0\text{ V}$ $V(\text{CANH}) = 5\text{ V}$ $V(\text{CANL}) = 5\text{ V}$	-5	0	5	μA
$V_i(\text{dif})(\text{th})$	Differential receiver threshold voltage for the wakeup detection	$-12\text{ V} < V(\text{CANH}) < 12\text{ V}$ $-12\text{ V} < V(\text{CANL}) < 12\text{ V}$	0.4	0.8	1.15	V

ELECTRICAL CHARACTERISTICS

(-40°C ≤ T_J ≤ 150°C, 6 V ≤ V_s ≤ 18 V, Normal mode, unless otherwise specified)

Table 28. CAN DYNAMIC CHARACTERISTICS

Symbol	Parameter	Test condition	Min	Typ	Max	Unit
td(TxDC-BusOn)	Delay TxDC to bus active	CL = 100 pF between CANH - CANL	10		110	ns
td(TxDC-BusOff)	Delay TxDC to bus inactive	CL = 100 pF between CANH - CANL	10		110	ns
td(BusOn-RxDC)	Delay bus active to RxDC	C(RxDC) = 15 pF	10		105	ns
td(BusOff-RxDC)	Delay bus inactive to RxDC	C(RxDC) = 15 pF	10		105	ns
tdPD(TxDC-RxDC)dr	Propagation delay TxDC to RxDC	CL = 100 pF between CANH - CANL	45		245	ns
tdPD(TxDC-RxDC)rd	Propagation delay TxDC to RxDC	CL = 100 pF between CANH - CANL	45		230	ns
tdBUS-hovr	Dominant time for wake-up via bus	LP mode Vdif(dom) > 1.4 V	0.5	2.5	5	μs
tdBUS-lovr	Dominant time for wake-up via bus	LP mode Vdif(dom) > 1.2 V	0.5	3	5.8	μs
T_TxDC_timeout	TxDC dominant time for time out	V(TxDC) = 0 V	300	650	1000	μs

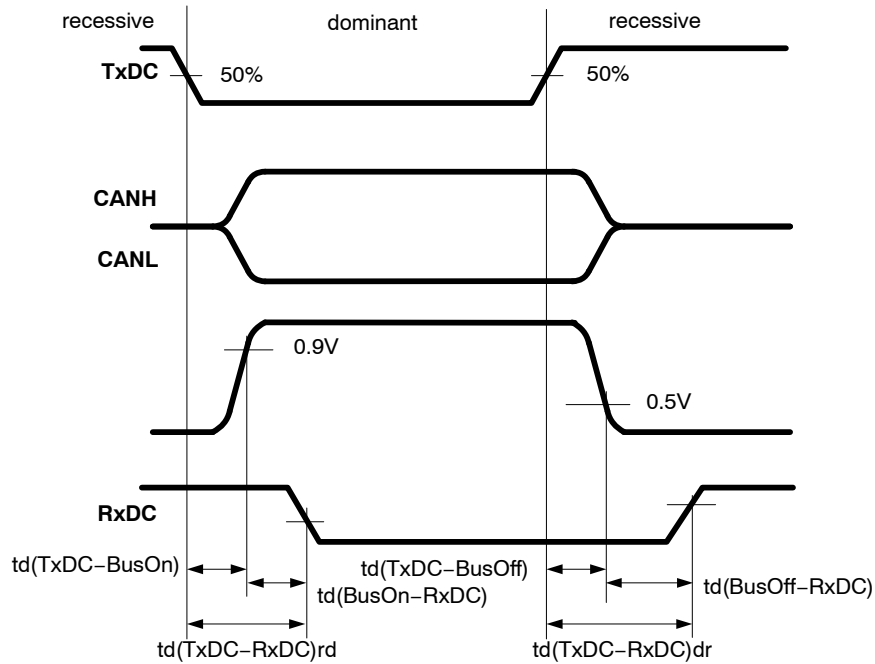

Figure 10. CAN Dynamic Characteristics

NCV7462

ELECTRICAL CHARACTERISTICS

($-40^{\circ}\text{C} \leq T_J \leq 150^{\circ}\text{C}$, $6\text{ V} \leq V_S \leq 18\text{ V}$, Normal mode, unless otherwise specified)

Table 29. VSPLIT CHARACTERISTICS

Symbol	Parameter	Test condition	Min	Typ	Max	Unit
VSPLIT	Reference output voltage at pin VSPLIT	Transmitter on $-500\ \mu\text{A} < I_{\text{split}} < 500\ \mu\text{A}$	0.3	0.5	0.7	V_{CC_CAN}
ISPLIT(li100)	VSPLIT leakage current	Transmitter off $-40\text{ V} < \text{VSPLIT} < 40\text{ V}$ $T_{\text{junc}} < 100^{\circ}\text{C}$	-1	0	1	μA
ISPLIT(li)	VSPLIT leakage current	Transmitter off $-40\text{ V} < \text{VSPLIT} < 40\text{ V}$	-5	0	5	μA
ISPLIT(lim)	Absolute value of limitation current at $\pm 35\text{ V}$ on VSPLIT	Transmitter on	1.3	3	5	mA

Table 30. RxDL/INTN, RxDC, SDO Outputs

Symbol	Parameter	Test condition	Min	Typ	Max	Unit
loutL_pinx	Low-level output driving current	pinx is logical Low forced $V(\text{pinx}) = 0.4\text{ V}$	2	5	12	mA
loutH_pinx	High-level output driving current	pinx is logical High forced $V(\text{pinx}) = V_{R1} - 0.4\text{ V}$	-12	-5	-2	mA
lleak_HZ_pinx	Leakage in the tristate, pin SDO	pinx in the HZ state forced $0\text{ V} < V(\text{pinx}) < V_{R1}$	-5		5	μA

Table 31. NRES Output

Symbol	Parameter	Test condition	Min	Typ	Max	Unit
VoutL_NRES	Low-level output voltage	$V_{R1} < 1\text{ V}$, $I(\text{NRES}) = 1\text{ mA}$		0.2	0.4	V
Rpullup_NRES	Internal pull-up resistor to V_{R1}		55	100	185	$\text{k}\Omega$

NCV7462

ELECTRICAL CHARACTERISTICS

($-40^{\circ}\text{C} \leq T_J \leq 150^{\circ}\text{C}$, $6\text{ V} \leq V_S \leq 18\text{ V}$, Normal mode, unless otherwise specified)

Table 32. TxDx/FLASH, SDI, SCLK, CSN Inputs

Symbol	Parameter	Test condition	Min	Typ	Max	Unit
VinL_pinx	Low-level input voltage		0		0.8	V
VinH_pinx	High-level input voltage		2		VR1	V
Vin_hys_pinx	Input voltage hysteresis		60		500	mV
Rpullup_pinx	Internal pull-up resistor to VR1; pins TxDx/FLASH, CSN		55	100	185	k Ω
Rpulldown_pinx	Internal pull-down resistor to ground; pins SDI, SCLK		55	100	185	k Ω
VinL_FLASH	Input low level for flash mode exit, pins TxDx/FLASH, TxDx/FLASH	VR1 \geq 2.5 V	VR1 + 1.5	VR1 + 2.5	VR1 + 3.5	V
VinH_FLASH	Input high level for flash mode entry, pins TxDx/FLASH, TxDx/FLASH		VR1 + 2.5	VR1 + 3.3	VR1 + 4.3	V
Vin_hys_FLASH	Input hysteresis, pins TxDx/FLASH, TxDx/FLASH		0.4	0.8	1.1	V

Product parametric performance is indicated in the Electrical Characteristics for the listed test conditions, unless otherwise noted. Product performance may not be indicated by the Electrical Characteristics if operated under different conditions.

FUNCTIONAL DESCRIPTION

The NCV7462 is a monolithic LIN/CAN System-Basis-Chip with enhanced feature set useful in automotive body control systems. Besides the bus interfaces the IC features two 5 V voltage regulators, several high-side and low-side switches to control LEDs and relays plus supervision functionality like a window watchdog. This allows a highly integrated solution by replacing external discrete components while maintaining the valuable flexibility. Due to this the board space and ECU weight can be minimized to the lowest level.

Power Supply and Regulators

VS – Main Power Supply

VS pin is the main power supply of the device. In the application, it will be typically connected to the KL30 or KL15 car node. It is necessary to provide an external reverse-polarity protection and filtering capacitor on the VS supply – see Figure 3.

VS supply is monitored with respect to the following events:

- VS power-on reset is detected as a crossing of VS_POR level (typ. 3.45 V). When VS remains below VS_POR, the device is passive and provides no functionality, the SPI registers are reset to their default values. When VS rises above VS_POR, the device starts following its state diagram through the power-up state. This event is latched in the SPI bit “COLD_START” so that the application software can detect the VS connection.
- VS Under-Voltage is detected when VS falls below VS_UV threshold (typ. 5.5 V). A VS under-voltage can be encountered, for example, with a discharged car battery or during engine cranking. The high-side and low-side drivers are typically forced off in order to protect the loads and LIN transmission is disabled. The exact driver reaction depends on the SPI control settings – see par. “VS Over- and Under-Voltage”. Under-voltage events are flagged through SPI bit “VS_UV”.
- VS Over-Voltage is detected when VS rises over VS_OV threshold (typ. 21 V). Similarly to the under-voltage, the high-side and low-side drivers are de-activated based on the SPI settings and the event is flagged through SPI bit “VS_OV”.

GND1, GND2 – Ground Connections

The device ground connection is split to two pins – GND1 and GND2. Both pins have to be connected on the application PCB.

Regulator VR1

VR1 is a low-drop output regulator providing 5 V voltage derived from the VS main supply. It is able to deliver up to 250 mA and is primarily intended to supply the application microcontroller unit (MCU) and related 5 V loads (e.g. its

own MCU-related digital inputs/outputs). An external capacitor needs to be connected on VR1 pin in order to ensure the regulator’s stability and to filter the disturbances caused by the connected loads.

The VR1 pin can also be used in the application to supply the on-chip CAN transceiver through the dedicated input pin VCC_CAN. The supply line must be carefully filtered by external components in this case so that the mutual disturbances between the CAN communication line and the other VR1 loads (mainly MCU) are limited.

VR1 voltage is supplying all digital low-voltage input/output pins.

The protection and monitoring of the VR1 regulator consist of the following features:

- VR1 Current Limitation – the current protection ensures fast enough charging of the external capacitor at start-up while protecting the regulator in case of shorts to ground
- Junction Temperature Monitor – the junction temperature is monitored and when it rises above the second shutdown level, the VR1 regulator is de-activated for a defined period of time (typ. 1 sec). In case of re-occurring thermal shutdowns, the device is forced to the sleep mode in order to protect the regulators and the full application. For details, see par. “Thermal Protection”.
- VR1 Failure Comparator – during the VR1 start-up and operation, the VR1 voltage is continuously compared with Vfail_VR1 level (typ. 2 V). During startup, if VR1 does not rise above Vfail_VR1 level within Tshort_VR1 (typ. 4 ms), it’s considered shorted to ground and the device is forced to sleep mode. During the VR1 operation, any dip below Vfail_VR1 level longer than Tfail_VR1 (typ. 5 μ s) is considered a failure – temporary excursions of VR1 under the failure threshold can be caused, for example, by EMC, and can lead to memory data inconsistencies inside the MCU. Both the failure during VR1 startup and the operation are latched in the “VR1_FAIL” SPI bit for subsequent software diagnostics.
- VR1 Reset Comparator – the VR1 regulator output is compared with a reset level VR1_RES (programmable to typ. 74%, 79%, 87% and 91% of the nominal VR1 voltage). If the VR1 level drops below this level for longer than Tflt_VR1_RES (typ. 16 μ s), a reset towards the MCU is generated through the NRES pin and all outputs (OUT1–4, LS1/2, VR2) are switched off until NRES pin becomes high and watchdog is served correctly.
- VR1 Consumption Monitor (Icmp) – to ensure a safe transition into the standby mode, where VR1 remains active while the watchdog is off, the VR1 current consumption is monitored. The watchdog is really

disabled in the standby mode only when the VR1 consumption falls below $I_{c\text{mp_VR1_fall}}$ (typ. 1.1 mA).

An increase of the VR1 consumption above the $I_{c\text{mp_VR1_rise}}$ level activates the watchdog again.

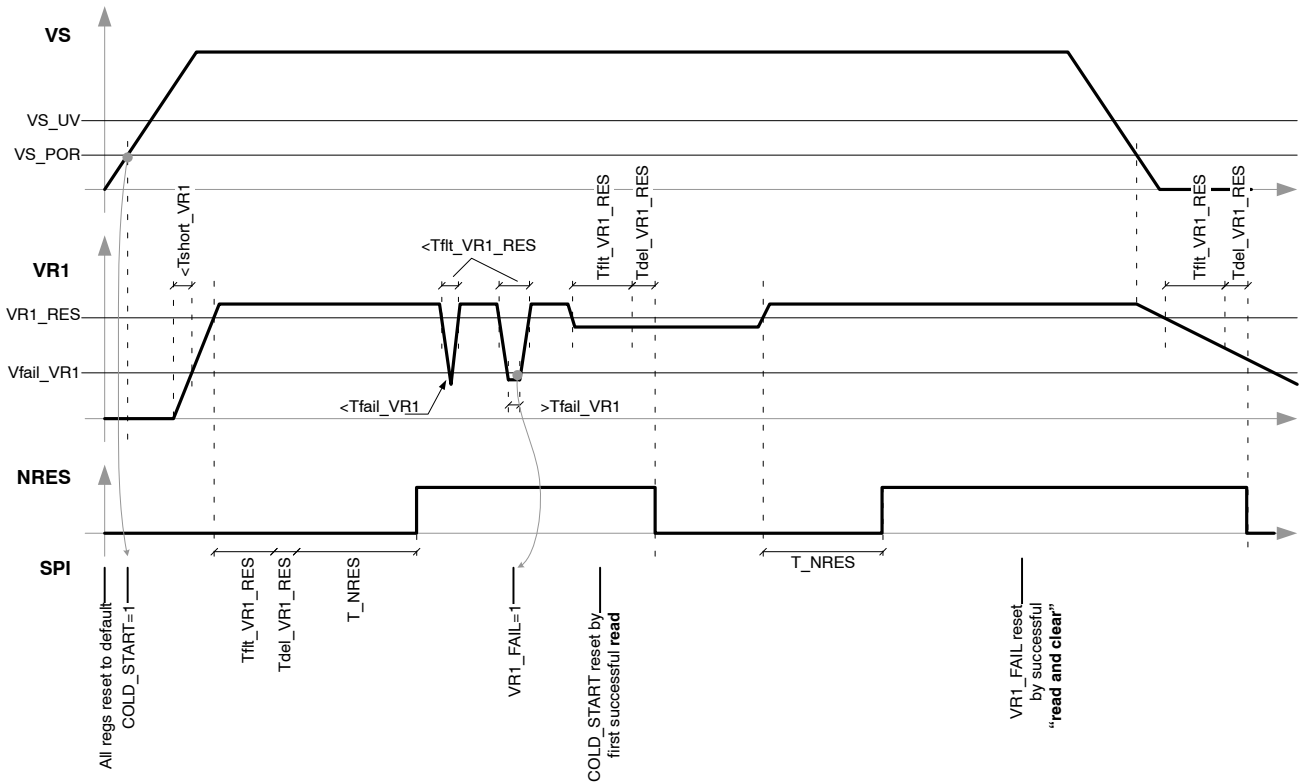

Figure 11. VR1 Monitoring

Regulator VR2

The device contains a second low-drop output regulator VR2, generating 5 V out of the VS main supply. The VR2 regulator can deliver up to 50 mA and is intended to supply additional 5 V loads – external sensors, potentiometers, logic etc. An external capacitor must be connected to the VR2 pin in order to provide stabilization and filtering.

It can also supply the on-chip CAN transceiver through the supply input pin VCC_CAN. Because the VR2 current capability does not cover the worst-case CAN transceiver consumption (for dominant transmission and/or a short-circuit on the bus), the external filtering capacitor on VR2 must be carefully dimensioned with respect to the expected CAN bus traffic and relevant environmental conditions (bus terminations, possible cabling failures etc.).

VR2 is protected and monitored by:

- VR2 Current Limitation
- Junction Temperature Monitor – when the junction temperature exceeds the first shutdown level, all load drivers, including VR2, are disabled and the event is flagged through the corresponding SPI status bit – see par. “Thermal Protection” for details.
- VR2 Failure Monitor – during the VR2 start-up and operation in normal and cyclic-sense standby/sleep modes, the VR2 voltage is continuously compared with

VR2_FAIL level (typ. 2 V). Two types of events can be detected based on this comparison:

- ♦ During VR2 operation, any dip below VR2_FAIL level longer than T_{fail_VR2} (typ. 2 μ s) is considered a transient failure. It is latched into the SPI bit “VR2_FAIL” for subsequent software diagnosis. The regulator remains active.
- ♦ If VR2 does not rise above VR_FAIL level within T_{short_VR2} (typ. 4 ms) or dips below the failure level during operation for the same time, it’s considered shorted to ground and the regulator is disabled automatically. SPI bits “VR2_FAIL” and “VR2_SHORT” are both set. Read/clear access to both of them is needed before the regulator can be enabled again. The VR2-related control bits remain unchanged.
- Short circuit and Reverse-Biasing Protection – the internal topology of VR2 regulator sustains VR2 shorts to ground and to the VS supply including reverse polarization between VR2 and VS nodes (when the VR2 short is combined with missing supply of the application module). VR2 can be therefore used to supply also loads connected to the module via external cabling.

CAN Transceiver Supply VCC_CAN

The on-chip CAN transceiver block uses two supply paths:

- From the VCC_CAN supply input: in the normal mode, when the transceiver is ready for transmission/reception.
- From the VS supply through internal pre-regulators – in standby and sleep modes, the transceiver monitors bus for remote wakeups. The VCC_CAN supply is not used.

For correct CAN transceiver function in the normal mode, the VCC_CAN pin must be decoupled with an external capacitor to ground.

In the normal operating mode, VCC_CAN supply input is monitored with an under-voltage comparator with level Vfail_VCAN (typ. 4.3 V). The output of the under-voltage detector can be read through SPI status bit “VCAN_UV”. This bit is a direct read-out (without latching) of the comparator’s output. When the CAN transceiver is enabled, a VCC_CAN under-voltage is additionally latched in the SPI status bit “VCAN_FAIL” for subsequent diagnostics. CAN transceiver functionality is disabled during VCC_CAN under-voltage.

Communication Transceivers

LIN Transceiver

The NCV7462 on-chip LIN transceiver is an interface between a physical LIN bus and the LIN protocol controller. It is compatible to LIN2.x and J2602 specifications.

Unlike the CAN transceiver, the LIN is supplied solely from the VS pin and its state control is therefore simpler:

- In the normal mode of the device, LIN transceiver transmits dominant or recessive symbols on the LIN bus based on the logical level on TxDL pin. The signal received from the bus is indicated on RxDL pin. Both logical pins are referred to the VR1 supply. A resistive pull-up path of typ. 30 kΩ is internally connected between LIN and VS. LIN pin remains recessive regardless the TxDL pin state during VS under-voltage. See par “VS Over- and Under-Voltage” for details.
- In the standby and sleep modes of the device, the LIN transceiver is in its wakeup detection state. Logical level on TxDL is ignored and pin RxDL is kept high until it’s used as an interrupt request signal. A LIN bus wakeup corresponds to a dominant symbol at least T_LIN_wake long (typ. 90 μs) followed by a rising edge (i.e. transition to recessive) – see Figure 9. In this way, false wakeups due to permanent LIN dominant failures are avoided. Only a pull-up current of typ. 15 μA is connected between VS and LIN instead of the 30 kΩ pull-up path. The LIN wakeup detection is by default active in the standby and sleep modes and can be disabled via SPI control registers.

The LIN transceiver features SPI-configurable TxDL dominant time-out timer. This circuit, if enabled, prevents

the bus lines being driven to a permanent dominant state (blocking all network communication) if pin TxDL is forced permanently low by a hardware and/or software application failure. The timer is triggered by a negative edge on pin TxDL. If the duration of the low-level on pin TxDL exceeds the internal timer value T_TxDL_timeout, the transmitter is disabled, driving the bus into a recessive state and the event is latched in the SPI status bit “TO_TxDL”. The transmission is de-blocked when “TO_TxDL” bit is reset by the corresponding register “read and clear”.

The LIN transceiver provides two LIN slope control modes, configured by SPI bit “LIN_SLOPE”.

In normal slope mode the transceiver can transmit and receive data via LIN bus with speed up to 20 kBaud according LIN2.x specification. This mode is used by default.

In low slope mode the slew rate of the signal on the LIN bus is reduced (rising and falling edges of the LIN bus signal are longer). This further reduces the EMC emission. As a consequence the maximum speed on the LIN bus is reduced to 10 kBaud. This mode is suited for applications where the communication speed is not critical. The low slope mode can be configured by setting SPI bit “LIN_SLOPE”.

CAN Transceiver

NCV7462 contains a high-speed CAN transceiver compliant with ISO11898-2 and ISO11898-5. It consists of the following sub-blocks: transmitter, receiver, wakeup detector, and common-mode stabilization pin VSPLIT

CAN transceiver control in the normal mode of the device is shown in Table 33. By default, the CAN transceiver is ready to provide the full-speed interface between the bus and a CAN controller connected on pins RxDC (received data) and TxDC (data to transmit). Through two dedicated SPI control bits, the CAN transceiver can be fully disabled or configured to “listen-only” functionality (RxDC pin continues to signal the received data while the logical level on TxDC is ignored and the transmitter remains in recessive).

The bus common mode can be additionally stabilized by using a split termination with the central tap connected to the VSPLIT pin. The transceiver and the VSPLIT are supplied from VCC_CAN supply input. In order to prevent a faulty node from blocking the bus traffic, the maximum length of the transmitted dominant symbol is limited by a time-out counter to t_TxDC_timeout (typ. 650 μs). In case the TxDC Low signal exceeds the timeout value, the transmitter returns automatically to recessive and the event is latched in the SPI bit “TO_TxDC”. The transmission is again de-blocked when “TO_TxDC” bit is reset by the corresponding register “read and clear”.

When the CAN transceiver is enabled in the normal operating mode, an under-voltage of VCC_CAN automatically blocks transmission and reception (recessive sent to the bus and RxDC remains High regardless the real CAN bus state). When the VCC_CAN returns above the

under-voltage level, the logical path between the transceiver and the RxDC/TxDC pins is immediately restored.

Table 33. CAN TRANSCEIVER CONTROL IN NORMAL MODE

Conditions and SPI Control			CAN Transceiver Behavior and SPI Flags					
VCC_CAN	CAN_DIS	CAN_LSTO	Transceiver	VSPLIT	TxDC	RxDC	VCAN_UV	VCAN_FAIL
>Vfail_VCAN	0	0	on	VCC_CAN/2	data to transmit	received data	0	keeps previous state until read&clear
	0	1	on	VCC_CAN/2	ignored	received data		
	1	X	powered-down	HZ	ignored	1		
<Vfail_VCAN	0	X	on	VCC_CAN/2	ignored	1	1	set to 1
	1	X	powered-down	HZ	ignored	1		

In the standby and sleep modes of the device, the CAN transceiver is switched to a low-power state, in which only bus wakeup detection is possible. CANH/L pins are biased to ground via the input stage and the VSPLIT pin is kept high-impedant. A valid wakeup on the CAN bus is detected when two consecutive dominants at least t_{DBUS_dom} long (typ. 2.5 μs) are received, each of them followed by a recessive symbol at least t_{DBUS_rec} long (typ. 2.5 μs). RxDC signal remains logically connected to the low-power receiver – it therefore indicates the immediate bus state without waiting for the wakeup pattern. In the standby and sleep modes of the device, the CAN wakeup detection is by default enabled and can be disabled via SPI control registers prior to enter the respective low-power mode.

High- and Low-Side Drivers

High-Side Drivers OUT1-4

High-side drivers OUT1-OUT4 are designed to supply mainly LED's or switches (for cyclic monitoring). When switched on, they connect the corresponding pin to the VS supply. Driver OUT1 can be configured to have two distinct levels of on-resistance: typically 2 Ω in “low-ohmic” and typically 7 Ω in “normal-ohmic” configuration (default). Drivers OUT2-4 have always a typical on-resistance of 7 Ω.

At the VS power-up or wakeup from the sleep mode, all OUT1-4 drivers are off. Immediately after the device enters the normal mode, they can be set to one of the following states via the corresponding SPI bits:

- Driver is off in all modes (default)
- Driver is on in all modes, except forced sleep mode
- Driver is activated periodically in all modes, except forced sleep mode. The periodicity is driven either by Timer 1 (period from 0.5 sec to 4 sec, on time 10 ms or 20 ms) or Timer 2 (period from 10 ms to 200 ms, on time 100 μs, 200 μs or 1 ms). Periodical activation can be used, for example, for LED flashing or cyclic contact monitoring.
- Driver is controlled by the on-chip PWM controller in the normal mode and standby or sleep mode with cyclic

sense active. Each OUTx driver has a dedicated 7-bit PWM duty cycle and the base frequency selectable through individual SPI settings.

The SPI settings for the drivers are applied immediately after the SPI frame is successfully completed (CSN rising edge). This can be done even immediately after the device initialization before the first watchdog service. If the watchdog trigger fails or VR1 under-voltage is detected, all drivers are immediately disabled and the SPI settings will be again applied once the watchdog is triggered correctly.

All OUTx outputs are protected by the following features in the normal and cyclic-sense standby and sleep modes:

- Over-current protection and current limitation: if the driver current exceeds the over-current limit for longer than T_{filt_OLD_OUTx} (typ. 60 μs), the event is latched into the SPI status bits and the driver is disabled. It will be again enabled only when the corresponding SPI flag is read and cleared.
- Under-load detection: during the on-time of the driver, a too low current indicates missing load. The under-load event is latched into the corresponding SPI status bits; however, the driver is not disabled and is controlled according the SPI bits. The under-load detection threshold of OUT1 driver depends on its selected on-resistance.
- Thermal protection and VS under/over-voltage protection: through monitoring of the junction temperature and the VS supply voltage; all loads are protected as described in par. “Protection”.

OUT3 output is also intended for failure indication. By default, OUT3 switch is not controlled by the SPI settings but by the internal FSO signal – see section “Fail-Safe (FSO) Signal”. Only when the FSO signal is disconnected from OUT3 by setting SPI bit “FSO_DIS”, OUT3 acts identically to OUT1, 2 and 4.

High-Side Driver OUT_HS

OUT_HS high-side driver is intended for LED's, switch monitoring as well as bulbs (5 W). The typical on resistance of OUT_HS is 1 Ω. Its configuration and protection features

are identical to the OUTx high-side drivers, only with different parametrical values.

At the VS power-up or wakeup from the sleep mode, OUT_HS driver is off. Immediately after the device enters the normal mode, it can be set to one of the following states via the corresponding SPI bits:

- Off in all modes (default)
- On in all modes, except forced sleep mode
- Periodical activation controlled by Timer 1 or Timer 2 in all modes, except forced sleep mode
- PWM control in normal mode and standby or sleep mode with cyclic sense active

OUT_HS output is protected by the following features in normal and cyclic-sense standby and sleep modes:

- Over-current protection and current limitation
- Under-load detection
- Thermal protection and VS under/over-voltage protection

Additionally, OUT_HS can be configured to bypass the over-current protection in case the connected load requires an important initial driving current (typically the inrush current with incandescent bulbs). This feature is referred to as over-current auto-recovery. An over-current on OUT_HS longer than Tblank_OLD_OUT_HS (typ. 120 μ s) will be latched to the SPI status bit and the driver will be switched off. However, if the SPI control bit "OUT_HS_OCR" is set high, OUT_HS will be automatically re-activated after Tflt_OCR (typ. 400 μ s) and no SPI status bit "OUT_HS_OC" is set. If the over-current condition persists, the driver enters into oscillations with typ. 120 μ s on, 400 μ s off (exact values depending on the load character). Typically, the MCU software will disable the auto-recovery once the load is supposed to settle (e.g. the bulb is heated up).

Low-Side Drivers LS1/2

NCV7462 offers two low-side drivers LS1 and LS2 primarily intended to drive relays, typically:

- R = 160 $\Omega \pm 10\%$, L = 240/300 mH
- R = 220 $\Omega \pm 10\%$, L = 330/420 mH

For the relay demagnetization, LS1/2 drivers feature active flyback clamps towards ground (no diode to VS) allowing to keep the load off even under load-dump condition on VS. Alternatively, LS1/2 can drive LED's.

LS1/2 can be configured in one of the following states:

- Off in all modes (default)
- On in the normal mode; off in all other modes
- Controlled by individual PWM in the normal mode; off in all other modes

LS1/2 is protected by:

- Over-current protection and current limitation: if the driver current exceeds the over-current limit for longer than Tflt_OLD_LS1/2 (typ. 60 μ s), the event is latched

into the SPI status bits and the driver is disabled. It will be again enabled only when the corresponding SPI flag is read and cleared.

- Thermal protection and VS under/over-voltage protection: through monitoring of the junction temperature and the VS supply voltage; all loads are protected as described in par. "Protection".

INH Output

INH high-side output is primarily intended to control an external regulator or the LIN master pull-up (see Figure 3). When the driver is active, it connects INH pin to the VS supply through a switch (on resistance typ. 23 Ω).

By default, INH is on in the normal mode and off in the standby and sleep modes. It can be switched off in all modes by setting SPI control bit "INH_OFF" high.

INH driver is neither over-current nor under-load protected – the output current is limited but INH will not be automatically switched off in case a current limitation is encountered. In the normal mode, it will be always switched off in case of the second thermal shutdown.

Wake-up Inputs WU1-3

NCV7462 offers three independent contact-monitoring inputs WU1-3 which can be used either for normal-mode contact polling or for contact change detection during the standby and sleep modes. In any mode, every WUx input can be configured into one of the following modes of operation:

- Static sense: the corresponding WUx input is constantly monitored by an input comparator and a filter of typ. 64 μ s. In the normal mode, the result of the comparison (the input high/low state) can be polled any time through the SPI status bits. In the standby and sleep modes, a change of the WUx polarity (in any direction) is recognized as a wakeup event. The MCU can then recognize the exact WUx wakeup source by reading "WU_WUx" SPI status bits.
- Cyclic sense: the WUx state detection is performed periodically as fostered by one of the internal timers: Timer 1 (period from 0.5 sec to 4 sec, WUx is left to settle for 800 μ s and the state detection is then done through a filter of typ. 16 μ s) or Timer 2 (period from 10 ms to 200 ms, on WUx is left to settle for 80 μ s or 800 μ s and the state detection is then done through a filter of typ. 16 μ s). The result of the periodical state detection is latched into the SPI status register and is not updated until the next period of the selected timer. A wakeup is detected in case sample of the WUx state changes in any direction.

Additionally, each WU1-3 input can be internally pre-biased by a pull-up or pull-down current source through individual control bits. If corresponding WUx wakeup is disabled, the pull-up current source is active in the normal mode only.

Table 34. WU1–3 PULL–DOWN / PULL–UP CONFIGURATION

Mode	WUx_DIS = 0		WUx_DIS=1	
	WUx_PUD = 0	WUx_PUD = 1	WUx_PUD = 0	WUx_PUD = 1
Normal	pull-down	pull-up	pull-down	pull-up
Standby	pull-down	pull-up	pull-down	floating
Sleep	pull-down	pull-up	pull-down	floating

In case cyclic sense is used, the WUx timer settings must be correctly chosen together with the high-side output settings. The driver physically ensuring the periodical contact supply must be set for the same timer as the contact monitor by the MCU software.

Operating Modes

NCV7462 can be configured to different operating modes in function of the application needs and the external conditions. The device resources can be enabled/disabled and the overall power consumption can be adapted to the electronic module state – ranging from full power mode down to a very low quiescent current “sleep” mode. The principal operating modes of NCV7462 are shown in Figure 12.

Un–Powered and Init Modes

As long as VS remains below the VS_POR level (typ. 3.45 V), the device is held in power-up reset. All outputs except NRES are in high–impedant state, the linear regulator outputs are off.

As soon as the VS main supply exceeds the power-on reset level, the device enters an initialization sequence represented by a transient “init” mode. All SPI registers are set to their default values, “COLD_START” SPI bit is set high for subsequent diagnostics and the VR1 regulator is started. After a successful start of the VR1 regulator (i.e. VR1 exceeds the VR1_FAIL level in less than Tshort_VR1 – typ. 4 ms), NRES is still kept low until VR1 reaches its reset level. After another 2 ms (parameter T_NRES), NRES is released to high and the device enters Normal mode with timeout watchdog.

In case VR1 does not start within Tshort_VR1, it’s again disabled, SPI “VR1_FAIL” bit is set and the device is forced into sleep mode. The forced sleep mode can be exited via any valid wakeup event or by VS re-connection. The initialization sequence is shown in Figure 11.

Normal Mode

In this mode the device provides full functionality, all resources are available. The voltage regulator VR1 is able to source 250 mA. MCU can enable/disable the device features via SPI as well as monitor the status of the device.

VR1 level is monitored through reset and failure comparators – see Figure 11. When the normal mode is entered, the watchdog is started in a timeout mode; a window watchdog mode is applied after the first correct watchdog service. The watchdog has to be correctly

triggered; otherwise a watchdog failure is detected resulting in reset signal to the MCU. Afterwards the watchdog is re-started in the timeout mode. After eight consecutive watchdog failures, the VR1 regulator is disabled for 200 ms and then re-started again. If the watchdog service still fails seven more times, the device is forced into sleep mode – the forced sleep mode can then be exited either via a wakeup or VS re-connection.

Through SPI bits “MOD_STBY” and “MOD_SLEEP”, the MCU can either keep the device in the normal mode, or request transition into one of the low-power modes – standby or sleep.

Standby Mode

Standby mode is the first low-power mode. The voltage regulator VR1 remains active while the watchdog is disabled. The standby mode is mainly intended to keep the application powered (e.g. for RAM content preservation) while the MCU is in a halt-state (software not running).

In order to make a safe transition into the standby mode, the watchdog will remain enabled even in the standby mode until the consumption from VR1 decreases below Icmp_VR1_fall level (typ. 1.1 mA). When the VR1 consumption increases back above Icmp_VR1_rise level (typ. 1.7 mA), the device will perform a wakeup from the standby mode to ensure supervision of the MCU software. The current supervision of VR1 can be disabled via SPI by setting the bit “ICMP_STBY”. VR1 also continues to be monitored by the reset circuit, which will generate a low NRES pulse in case the regulator output drops below the reset level.

During the standby mode, several types of wakeup events can be signaled to the MCU through INTN pin: timer1 or timer2 expiration, wakeup on CAN or LIN buses, change on WUx pin (as per the SPI settings), or SPI activity. Increased consumption from VR1 is not signaled through INTN pin. After a wakeup, the watchdog is started in timeout mode and MCU can request a mode transition afterwards.

Sleep Mode

Sleep mode is the mode with the lowest consumption. VR1 regulator and the watchdog are inactive. The device maintains minimum operation allowing reception of wake-up events generated by the pins WUx (as per SPI settings), LIN and CAN bus line or driven by timer1 or timer2. In case of a wake-up event the device switches from

the sleep mode to the normal mode (through the init mode, as the VR1 must be started similarly to the VS power-up).

Forced Sleep Mode

Forced sleep mode is the mode equal to the sleep mode, but all peripherals (VR1/2, OUT_HS, OUT1-4, LS1/2) and the watchdog are inactive.

Forced sleep mode is entered after following failure conditions:

- VR1 did not reach Vfail_VR1 level (typ. 2 V) within Tshort_VR1 during startup (VS connection or wakeup from sleep mode)
- Fifteen consecutive watchdog failures occur
- The device junction temperature exceeded thermal shutdown level Tsd2 (typ. 155°C) for eight times within one minute

Flash Mode

Flash mode is identical to the normal mode with the exception of the watchdog which is disabled. Neither the standby nor sleep mode can be entered (the corresponding SPI requests will be ignored). The purpose of the flash mode is to enable transfer of bigger bulk of data between the MCU and a programming interface – typically during the module-level production. The flash mode will be entered if the voltage applied on TxDL or TxDC pin exceeds the corresponding comparison level VinH_FLASH (typ. VR1 + 3.3 V).

NCV7462

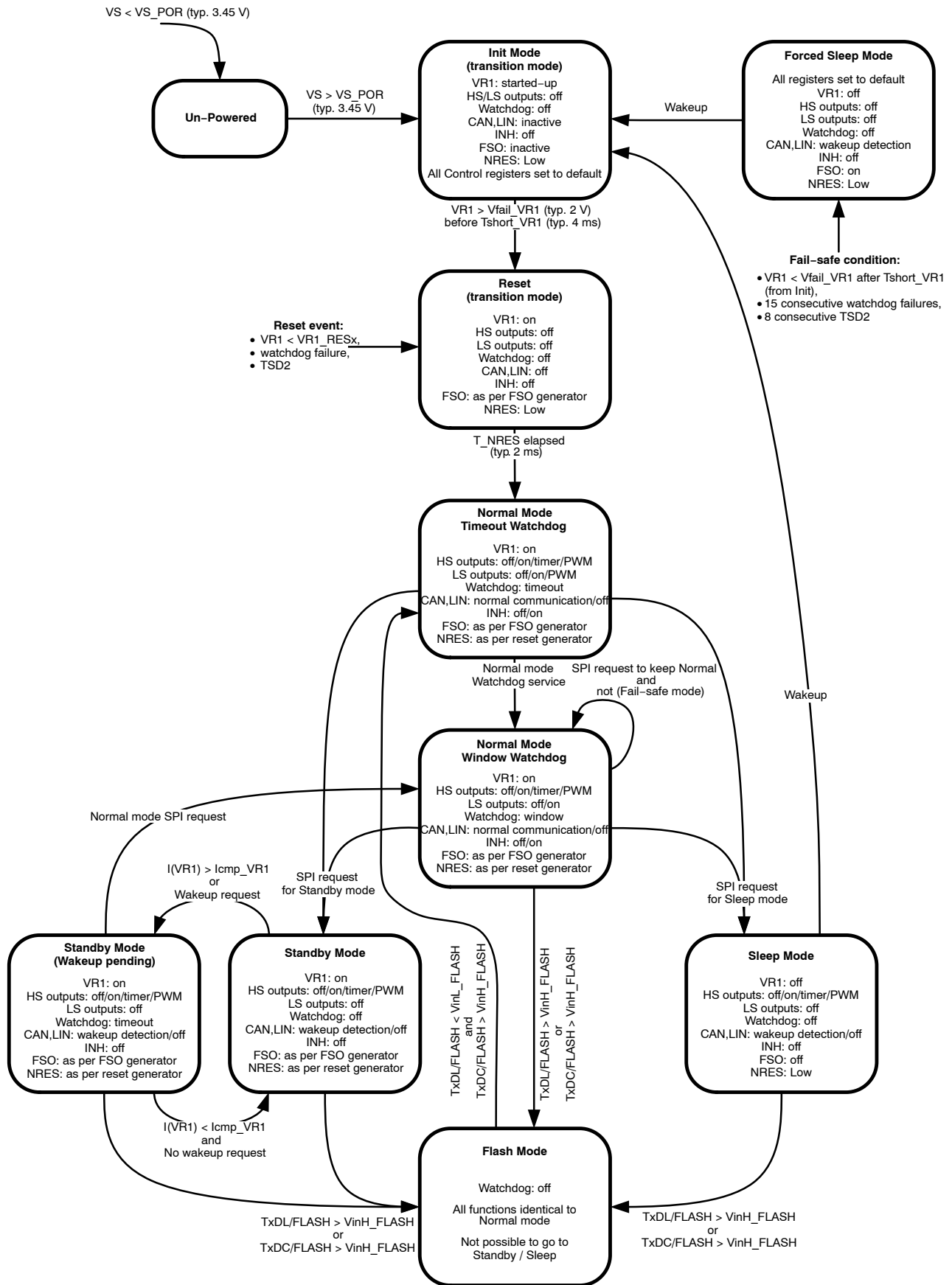

Figure 12. Principal Operating Modes

Wake-up Events

In the standby and sleep modes, NCV7462 can detect several types of wake-up events summarized in Table 35:

- In the sleep modes, a wakeup will cause a reset (low signal at NRES pin) and initialization of VR1 regulator. After the release of the NRES signal, the timeout watchdog will be started and the device enters the normal mode and SPI registers will be set into their default values. The following events will cause wakeup from the sleep mode:
 - ◆ Bus wakeups through CAN or LIN – can be enabled/disabled through SPI
 - ◆ Switch monitoring on WUx inputs – can be configured and enabled/disabled through SPI
 - ◆ Timer wakeup – timer1 and timer2 can be configured to cause a wakeup after a fixed time period – the selected timer is started at the moment the sleep mode is requested and causes wakeup immediately when the selected time period expires. The timer wakeup can be configured and enabled/disabled by SPI.
- From the standby mode, where VR1 remains active, a wakeup event will cause watchdog startup in timeout mode:
 - ◆ SPI wakeup (CSN low and rising edge on SCLK). Interrupt request is generated.
 - ◆ VR1 consumption wakeup (VR1 consumption exceeds the Icmp_VR1_rise level; can be disabled by SPI control). No interrupt request is generated. If

VR1 consumption falls below the Icmp_VR1_fall level within the timeout period, the watchdog is disabled again.

- ◆ Bus wakeups through CAN or LIN, switch monitoring on WUx and timer wakeups have the same meaning as in the sleep mode. Any of them will cause an interrupt request.

Every valid wakeup event starts the timeout watchdog, which then must be correctly triggered. If another wakeup event occurs during the initial timeout watchdog, it will be only registered into the SPI status and will not cause an interrupt or re-start of the watchdog. E.g., an increase of the VR1 consumption will start the watchdog timeout timer while the device remains in the standby mode. If, for example, a CAN wakeup is then detected, it will be latched into the SPI registers, but no new interrupt will be generated and the watchdog will keep running.

In all wakeup cases in the standby mode the device remains in the standby mode until it is changed. SPI settings for drivers and VR2 are applied after the correct watchdog service.

In case all wakeup sources are disabled while the standby or sleep mode is entered through a SPI request, LIN and CAN wakeups are automatically enabled (SPI bits “WU_LIN_DIS” and “WU_CAN_DIS” are ignored). If all the wakeup sources are disabled prior to the standby mode entry and CAN or LIN wakeup occurs in the standby mode, the watchdog is started and has to be served within typ. 1.5 ms. Otherwise, NRES pulse is generated and all the SPI registers are set into their default states.

Table 35. WAKEUP EVENTS

Device Mode	Wakeup Event	SPI Default	SPI Control	NRES Pulse	INTN Pulse
Standby	SPI	N/A	cannot be disabled	no	yes
	I(VR1) > Icmp	enabled	can be enabled/disabled		no
	Bus wakeup (CAN or LIN)	enabled			yes
	WU1-3 change	enabled			
	Timer1/2 wakeup	disabled			
Sleep	Bus wakeup (CAN or LIN)	enabled	can be enabled/disabled	yes	no
	WU1-3 change	enabled			
	Timer1/2 wakeup	disabled			
Forced Sleep	Bus wakeup (CAN or LIN)	enabled	previous SPI configuration maintained	yes	no
	WU1-3 change	enabled			
	Timer1/2 wakeup	disabled			

Watchdog

The on-chip watchdog requires that the MCU software sends specific SPI messages (watchdog “triggers” or “services”) in a specified time frame. A correct watchdog trigger/service consists of a write access to SPI register CONTROL_0 with “WD_TRIG” bit inverted compared to its previous state. The watchdog timer re-starts immediately after a successful trigger is received.

A read access to the CONTROL_0 register or a write access with “WD_TRIG” bit unchanged does not trigger the watchdog. The moment of the watchdog trigger corresponds to the rising edge of the CSN signal (end of the SPI frame). The watchdog can work in the following modes (see Figures 13 and 14):

- Off; the watchdog is always off in the sleep and flash modes. It is also off in the standby mode, provided that the VR1 consumption stays below the Icmp limit, or when the Icmp comparator is disabled.
- Timeout: the watchdog works as a timeout timer. The MCU software must serve the watchdog any time before the time-out expiration (typ. 65 ms). Timeout watchdog is started after reset events (power-up, watchdog failure, VR1 under-voltage in normal mode, thermal shutdown 2) and by any wakeup event from both standby and sleep mode. The timeout watchdog is started regardless if the wakeup is or is not accompanied by a reset. Watchdog counter position is reflected in SPI status bits “WD_STATUS[1:0]”.

- Window: the watchdog time is split to two distinct parts – a closed window, where the watchdog may not be triggered, is followed by an open window where the MCU must send a valid watchdog trigger. Window watchdog is used during the normal operating mode of the device after the initial timeout watchdog is correctly triggered. Position of the watchdog counter inside the open window is reflected in SPI status bits “WD_STATUS[1:0]”.
- Failure: If the watchdog is not triggered correctly (trigger not sent during timeout or open window; or sent during the closed window), reset is generated on pin NRES and the “WD_TRIG” bit is reset to low. After the NRES release, the watchdog always starts in the timeout mode. Watchdog failures are counted and their number can be read from the SPI status registers. After eight watchdog failures in sequence, the VR1 regulator is switched off for 200 ms. In case of seven more watchdog failures, VR1 is completely turned off and the device goes into forced sleep mode until a wake-up occurs (e.g. via the LIN or CAN bus). First successful watchdog trigger resets the failure counter. The watchdog time for window mode is selectable from four different values by SPI bits “WD_PER[1:0]”. The watchdog time setting is applied only if it’s contained in an SPI frame representing a correct watchdog trigger message. The setting is ignored otherwise.

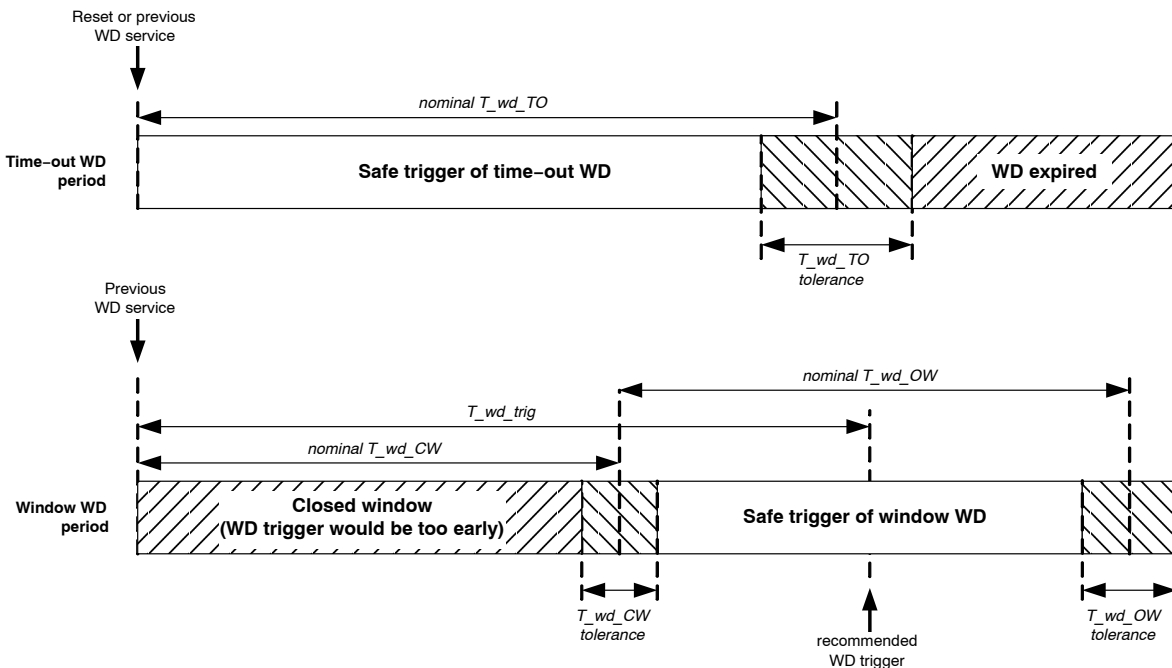

Figure 13. Watchdog Modes Timing

NCV7462

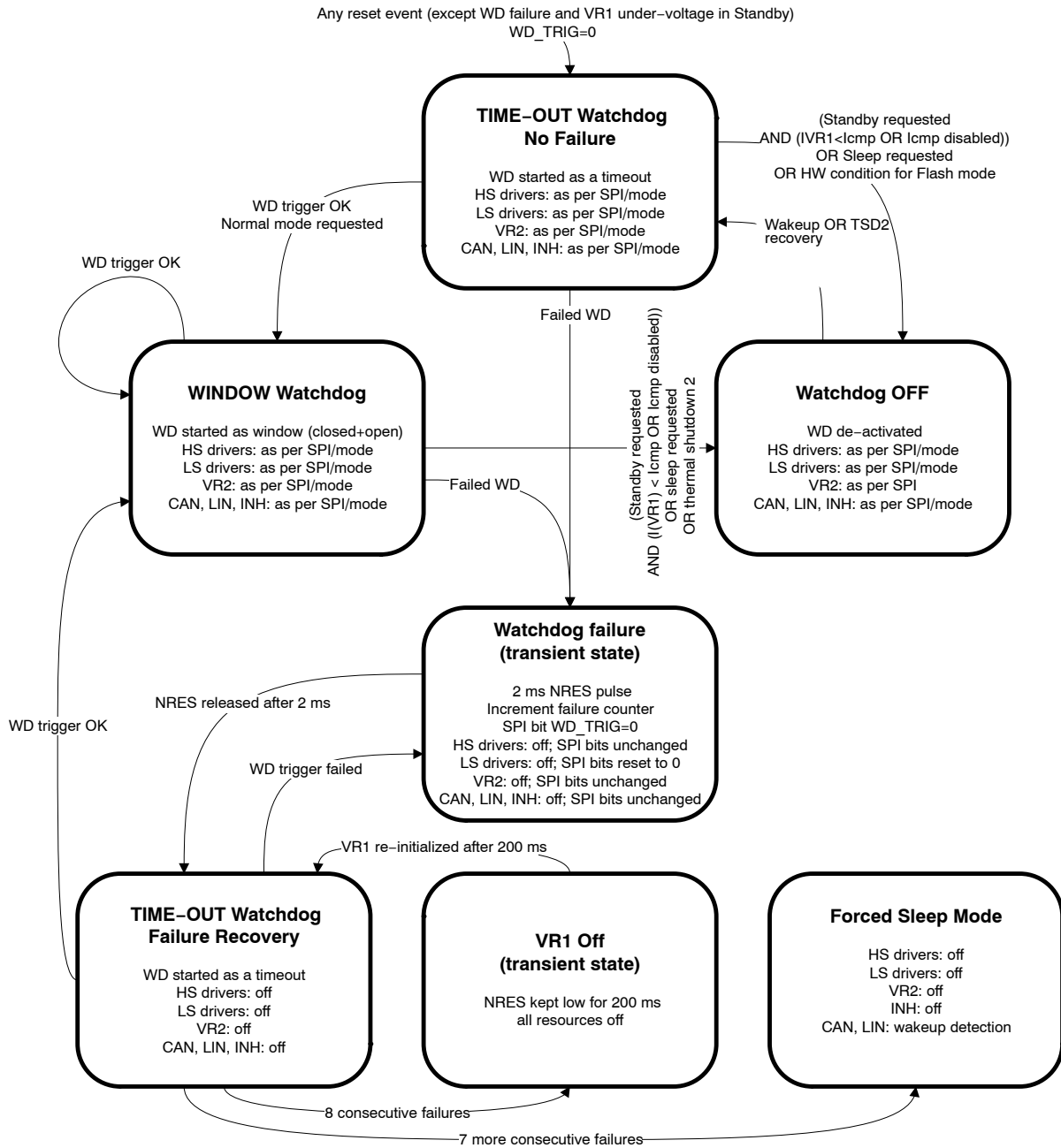

Figure 14. Watchdog Operation

Protection

Thermal Protection

The device junction temperature is monitored in order to avoid permanent degradation or damage. Three distinct junction temperature levels are provided – thermal warning level T_{jw} (typ. 130°C), thermal shutdown level 1 $T_{j\text{sd}1}$ (typ. 140°C) and thermal shutdown level 2 $T_{j\text{sd}2}$ (typ. 155°C). The thermal protection circuit is always active in the normal mode. It is also active in the standby and sleep modes if any of the high-side outputs is used for cyclic switch monitoring.

When the junction temperature exceeds the warning level, the event is only latched into the SPI for subsequent diagnostics without any direct effect on the device

configuration. When the first thermal shutdown level is exceeded, most of the power-consuming functions are disabled (high- and low- side drivers, VR2) while VR1 keeps running so that the MCU can still take appropriate actions. Junction temperature above the second shutdown level leads to complete device de-activation, VR1 included. VR1 is re-started after a waiting time of one second in case the junction temperature drops below the second shutdown level. If the second thermal shutdown then re-occurs eight times within 1 minute, the device is forced into the sleep mode.

The details of the thermal protection handling are shown in Figure 15 (for normal mode and standby mode with cyclic sense) and in Figure 16 (for sleep mode with cyclic sense).

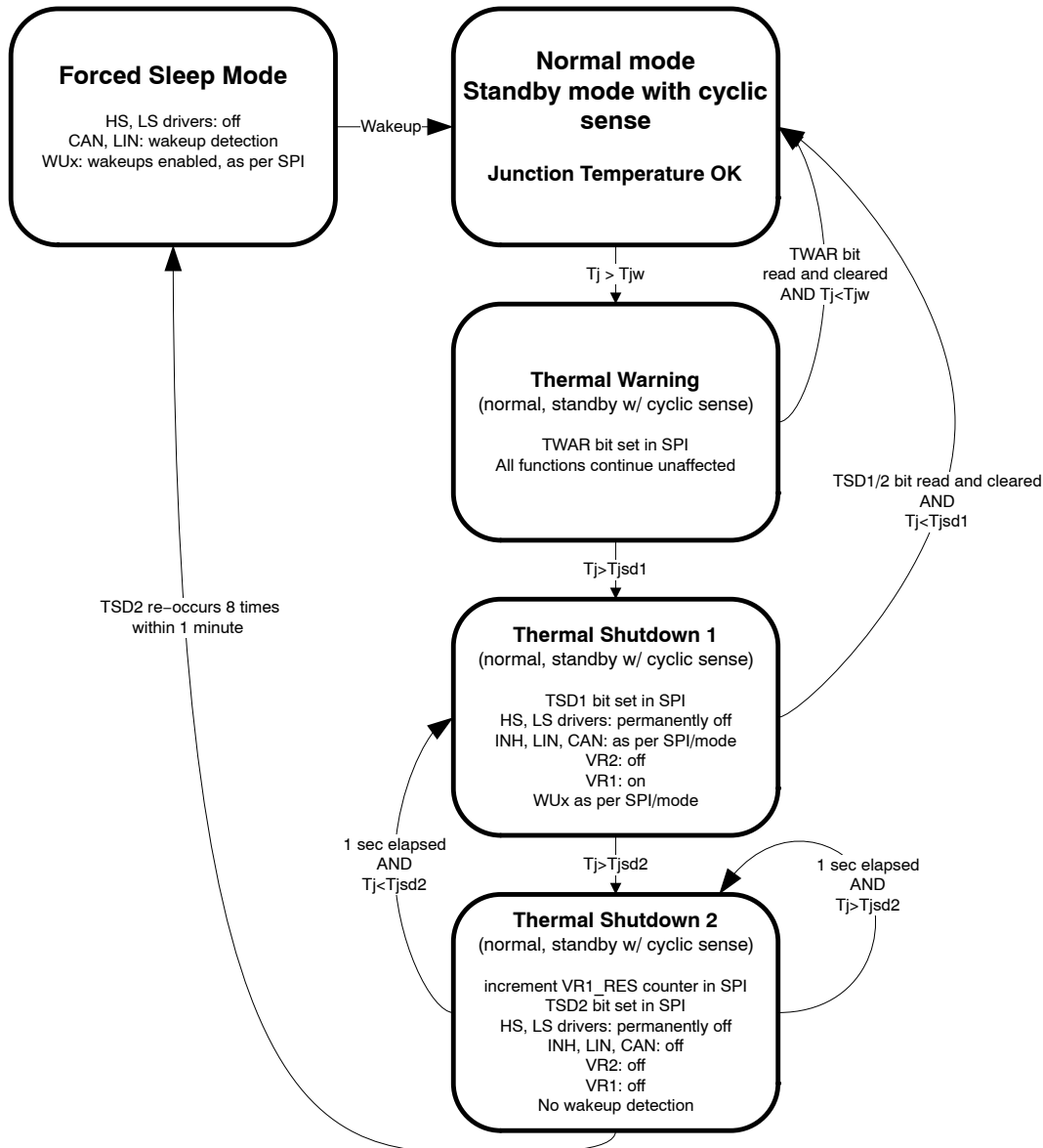

Figure 15. Thermal Protection in Normal and Standby Modes

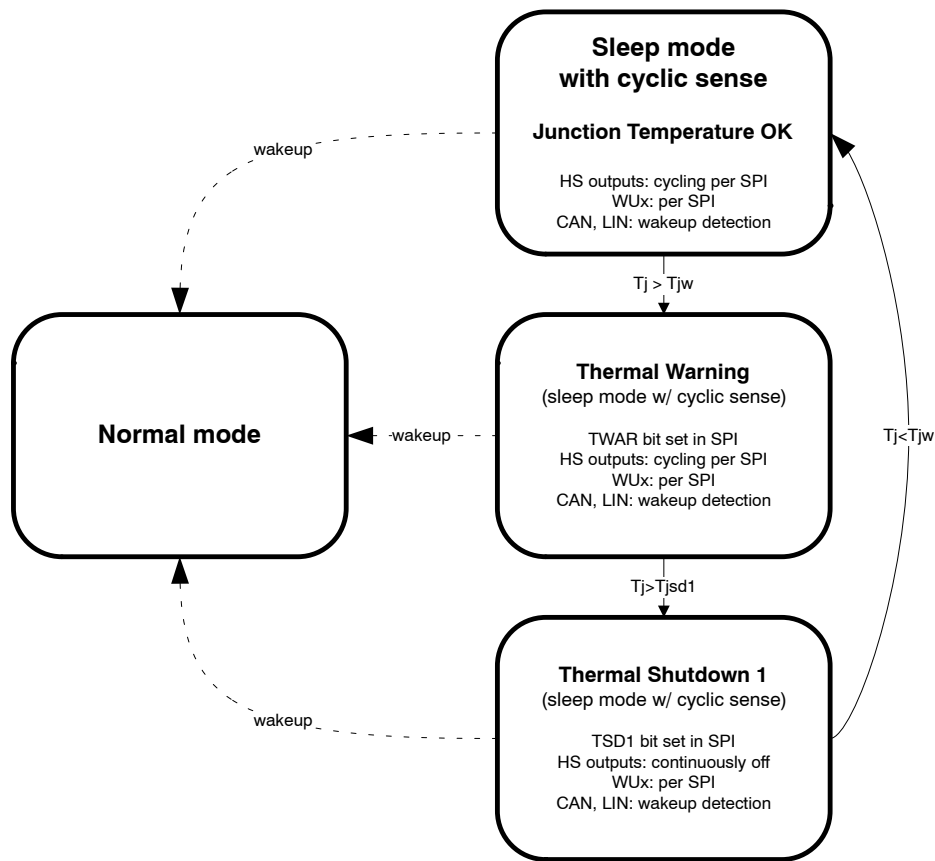

Figure 16. Thermal Protection in Sleep Mode

VS Over- and Under-Voltage

In order to protect the loads connected to the high- and low- side drivers, the VS (car battery) supply is compared against two levels – under-voltage level VS_UV (typ. 5.5 V) and VS_OV (typ. 21 V). The VS monitoring circuitry is active in normal mode as well as in the standby and sleep modes when any high-side output is used for cyclic switch monitoring.

Whenever VS falls below the VS_UV level or rises above VS_OV level, all high-side drivers are disabled. The under/over-voltage event is latched in the corresponding SPI status bit. If the SPI control bit “LS_OVUV” is low, the same action is taken for the low-side drivers. After the VS under/over-voltage condition disappears, it remains flagged in the SPI status. If the SPI control bit “VS_LOCKOUT_DIS” is low, the drivers will remain deactivated until the corresponding flag is not read and

cleared. If “VS_LOCKOUT_DIS” is high, the drivers will return to their state defined by SPI registers settings. The details of the VS monitoring are shown in Figure 17.

SPI control bit “VS_LOCKOUT_DIS” is ignored by OUT3 driver in case it is controlled by FSO signal. OUT3 will return to the previous state immediately after VS under/over-voltage disappears.

Whenever VS falls below the VS_UV level, the LIN transmitter is disabled. If VS under-voltage condition disappears and SPI control bit “VS_LOCKOUT_DIS” is low, LIN transmission is blocked until SPI flag “VS_UV” is not read and cleared. If “VS_LOCKOUT_DIS” is high, LIN transmission is possible immediately when VS voltage returns above VS_UV threshold. A falling edge on TxDL pin is needed to start LIN transmission, to prevent unwanted glitches on LIN bus.

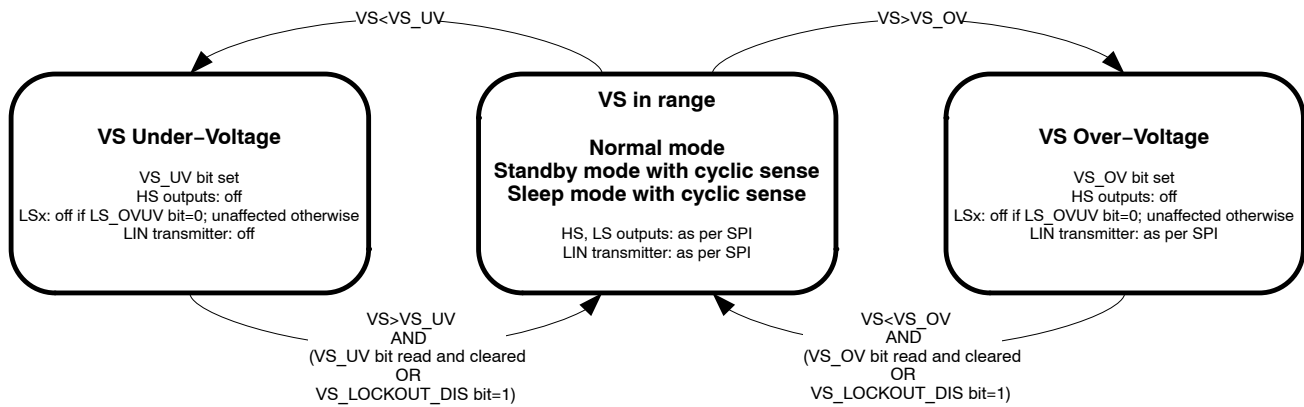

Figure 17. Under- and Over-voltage on VS Supply

Reset Signal NRES

NRES is an open-drain output with an internal pull-up resistor connected to VR1. It signals reset to the MCU as a consequence of several specific events:

- VR1 under-voltage (including VS power-up)
- Watchdog failure
- Thermal shutdown level 2
- Wakeup (in case the wakeup is accompanied by reset – see Table 35)
- (Forced) Sleep mode

The low-level pulse on NRES pins always extends T_{NRES} (typ. 2 ms) beyond the reset event – e.g. a watchdog failure causes a 2 ms NRES low pulse; a VR1 under-voltage causes NRES pulse extending 2 ms beyond the under-voltage disappearance.

After NRES pulse, which was caused by VR1 under-voltage or watchdog failure, all outputs (OUT1–4, LS1/2 and VR2) are inactive. SPI registers content is preserved. Outputs follow relevant SPI register settings after the correct watchdog setting again.

LIN and CAN transmission is blocked during NRES pulse. CAN and LIN receivers are enabled if NRES pulse was caused by VR1 undervoltage, disabled otherwise. A recessive-to-dominant edge on TxDL pin after NRES pulse is required to start transmission to LIN bus.

Interrupt Signal

An interrupt request is used in the standby mode to indicate some of the wakeup events to the MCU – see section “Wake-up Events”. Interrupt is signaled through RxDL pin by pulling it Low for typically 125 μs. Beside the 125 μs Low pulse, RxDL remains High throughout the standby mode.

During normal mode, RxDL assumes its normal function (LIN received data).

Operational Amplifiers

Two operating amplifiers are provided for, mainly, current sensing (see Figure 3). The operating amplifiers are on (i.e.

biased) in the normal mode. They are powered-down in all other modes.

The input voltage common mode covers the range from –0.2 V to 3 V. The rail-to-rail (VS) output voltage allows using them together with an external pass element as additional voltage regulator.

Fail-Safe (FSO) Signal

A fail-safe signal is internally generated reflecting some critical system failures and events. By default, the signal is connected to the OUT3 output and over-rides the OUT3 SPI settings – active FSO signal switches OUT3 on, inactive FSO signal switches OUT3 off. In case the SPI bit “FSO_DIS” is set, OUT3 acts as a general-purpose high-side driver identically to OUT1, 2 and 4. FSO remains then only an internal signal not visible to the application.

FSO internal signal is active in the following cases:

- During the Init phase:
 - ♦ VR1 short: FSO is active when VR1 is below its failure level (V_{fail_VR1}) for more than T_{short_VR1} (typ. 4 ms) during VR1 regulator startup and VS is above VS_UV threshold (typ. 5.5 V).
- In the normal and standby modes:
 - ♦ VR1 under-voltage: FSO is active when VR1 is below its reset level (VR1_RES).
 - ♦ Watchdog: FSO is immediately activated in case of failed watchdog trigger. It is deactivated only when the watchdog is correctly triggered again.
 - ♦ Thermal shutdown: FSO is active when the junction temperature is above the second shutdown threshold (T_{jsd2}).
- In the forced sleep modes: FSO is active if the forced sleep mode was entered because of a failure condition, like non-starting VR1, repeated thermal shutdown or repeated watchdog failures. If the sleep mode is entered by a correct SPI mode-transition request, FSO remains inactive.

SPI CONTROL

Serial Peripheral Interface (SPI) is the main communication channel between the application MCU and NCV7462. The structure of a SPI frame is shown in Figure 18. MCU starts the frame by sending an 8-bit header consisting of two bits of register access mode type followed by a six-bit address. During the header transmission, NCV7462 sends out eight bits of status information regardless the address. After the header, sixteen bits of data are exchanged. A correct SPI frame has either no bits (no SCLK edges during CSN low; serves to read out the global status information) or exactly twenty-four bits. If another amount of clock edges occurs during CSN low, the frame is considered incorrect and the input data are always ignored.

Depending on the access type, the transmitted/received data are treated differently:

- ◆ During a write access, SDO signals current content of the register while new data for the same register are received on SDI. The register is refreshed with the new data after a successful completion of the

frame (rising edge on CSN). Only the bits eligible for write access are refreshed, the input data are ignored for the others (e.g. a write access to status registers).

- ◆ For read access, the data on SDI are ignored; SDO signals data content of the register addressed by the header. After the frame completion, the register content remains unchanged regardless the type of the individual bits.
- ◆ For read and clear access, a normal register read is performed. When the frame is completed (CSN rising edge), the register bits eligible for read/clear access are reset to 0.
- ◆ Device ROM access switches the address space to sixteen-bit constant data memorized in the NCV7462 (indicating the device version, SPI frame format and other information). Input data are ignored.

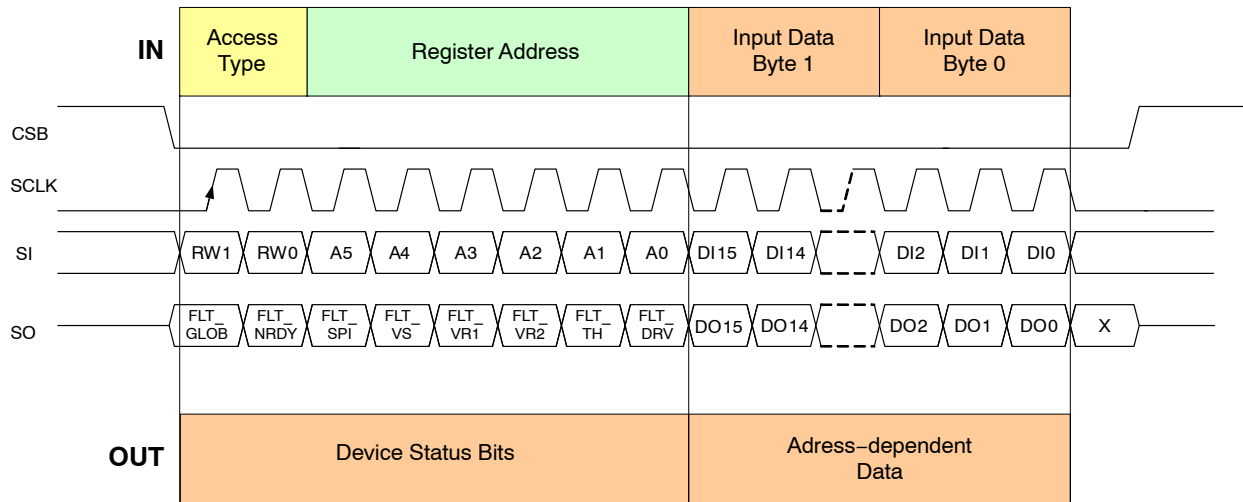

Figure 18. SPI Frame

NCV7462

SPI Frame Format

	D23	D22	D21	D20	D19	D18	D17	D16	D15	...	D0
NCV7462 IN	RW1	RW0	A5	A4	A3	A2	A1	A0	D15	...	D10
NCV7462 OUT	FLT_GLOB	FLT_NRDY	FLT_SPI	FLT_VS	FLT_VR1	FLT_VR2	FLT_TH	FLT_DRV	DO15	...	DO0

Inframe:

SPI Access Type	RW1	RW0	Description
	0	0	Write to SPI register
	0	1	Read only from SPI register
	1	0	Read and clear SPI register
	1	1	Access device ROM

SPI Registers	A5	A4	A3	A2	A1	A0	Register	
	0	0	0	0	0	0	0	CONTROL_0
	0	0	0	0	0	0	1	CONTROL_1
	0	0	0	0	1	0	CONTROL_2	
	0	0	0	0	1	1	CONTROL_3	
	0	0	0	1	0	0	CONTROL_4	
	0	0	0	1	0	1	PWM_HS	
	0	0	0	1	1	0	PWM_OUT1/2	
	0	0	0	1	1	1	PWM_OUT3/4	
	0	0	1	0	0	0	PWM_LS	
	0	0	1	0	0	1	STATUS_0	
	0	0	1	0	1	0	STATUS_1	
	0	0	1	0	1	1	STATUS_2	
	0	0	1	1	X	X	reserved	
	0	1	X	X	X	X	reserved	
1	X	X	X	X	X	reserved		

Device ROM	A5	A4	A3	A2	A1	A0	Data content	Comment
	0	0	0	0	0	0	\$4300	ID_HEADER
	0	0	0	0	0	1	\$4404 or \$5104 \$5204	PRODUCT VERSION NCV7462-0 NCV7462-1
	0	0	0	0	1	0	\$7400	PRODUCT CODE 1
	0	0	0	0	1	1	\$6200	PRODUCT CODE 2
	0	0	0	1	0	0	reserved	
	reserved	
	1	1	1	1	0	1	reserved	
	1	1	1	1	1	0	\$0200	SPI_FRAME_ID
1	1	1	1	1	1	reserved		

Outframe:

General Device Status Info	SDO bit	Bit Name	Bit Content
	D23	FLT_GLOB	Logical combination (OR) of all following flags
	D22	FLT_NRDY	reserved
	D21	FLT_SPI	Previous SPI frame faulty – wrong number of clocks or addressing a nonexistent address
	D20	FLT_VS	VS_OV OR VS_UV
	D19	FLT_VR1	Equal to VR1_FAIL bit
	D18	FLT_VR2	VR2_FAIL OR VR2_SHORT
	D17	FLT_TH	TSD2 OR TSD1 OR TWAR
D16	FLT_DRV	OR combination of all overcurrent and underload bits of OUT_HS, OUTx and LSx	

SPI Registers Overview

In the below register overview, each bit is marked with the available SPI access. Every bit can be read. Those marked “RW” can be additionally written to; bits marked “R/RC” can be additionally read and cleared.

SPI REGISTERS OVERVIEW

CONTROL_0	D15	D14	D13	D12	D11	D10	D9	D8
	RW	RW	RW	RW	RW	RW	RW	RW
	MOD_STBY	MOD_SLEEP	WD_TRIG	WD_PER.1	WD_PER.0	ICMP_STBY	VR2_ON.1	VR2_ON.0
	D7	D6	D5	D4	D3	D2	D1	D0
	RW	RW	RW	RW	RW	RW	RW	RW
	VR1_RES.1	VR1_RES.0	CAN_DIS	CAN_LSTO	LIN_SLOPE	TXDL_TO.1	TXDL_TO.0	FSO_DIS

CONTROL_1	D15	D14	D13	D12	D11	D10	D9	D8
	RW	RW	RW	RW	RW	RW	RW	RW
	WU_CAN_DIS	WU_LIN_DIS	WU_TIM_EN.1	WU_TIM_EN.0	WU3_DIS	WU2_DIS	WU1_DIS	WU3_PUD
	D7	D6	D5	D4	D3	D2	D1	D0
	RW	RW	RW	RW	RW	RW	RW	RW
	WU2_PUD	WU1_PUD	WU3_T.1	WU3_T.0	WU2_T.1	WU2_T.0	WU1_T.1	WU1_T.0

CONTROL_2	D15	D14	D13	D12	D11	D10	D9	D8
	RW	RW	RW	RW	RW	RW	RW	RW
	reserved	reserved	reserved	reserved	reserved	reserved	reserved	reserved
	D7	D6	D5	D4	D3	D2	D1	D0
	RW	RW	RW	RW	RW	RW	RW	RW
	T2_TPER.1	T2_TPER.0	T2_TON.1	T2_TON.0	T1_TPER.2	T1_TPER.1	T1_TPER.0	T1_TON

CONTROL_3	D15	D14	D13	D12	D11	D10	D9	D8
	RW	RW	RW	RW	RW	RW	RW	RW
	reserved	reserved	reserved	reserved	reserved	reserved	reserved	reserved
	D7	D6	D5	D4	D3	D2	D1	D0
	RW	RW	RW	RW	RW	RW	RW	RW
	VS_LOCKOUT_DIS	LS_OVUV	LS2_ON.1	LS2_ON.0	LS1_ON.1	LS1_ON.0	INH_OFF	OUT_HS_OCR

SPI REGISTERS OVERVIEW

CONTROL_4	D15	D14	D13	D12	D11	D10	D9	D8
	RW	RW	RW	RW	RW	RW	RW	RW
	OUT1_LOWR	OUT4_ON.2	OUT4_ON.1	OUT4_ON.0	OUT3_ON.2	OUT3_ON.1	OUT3_ON.0	OUT2_ON.2
	D7	D6	D5	D4	D3	D2	D1	D0
	RW	RW	RW	RW	RW	RW	RW	RW
OUT2_ON.1	OUT2_ON.0	OUT1_ON.2	OUT1_ON.1	OUT1_ON.0	OUT_HS_ON.2	OUT_HS_ON.1	OUT_HS_ON.0	

PWM_HS	D15	D14	D13	D12	D11	D10	D9	D8
	RW	RW	RW	RW	RW	RW	RW	RW
	reserved	reserved	reserved	reserved	reserved	reserved	reserved	reserved
	D7	D6	D5	D4	D3	D2	D1	D0
	RW	RW	RW	RW	RW	RW	RW	RW
FSEL_HS	PW_HS.6	PW_HS.5	PW_HS.4	PW_HS.3	PW_HS.2	PW_HS.1	PW_HS.0	

PWM_OUT1/2	D15	D14	D13	D12	D11	D10	D9	D8
	RW	RW	RW	RW	RW	RW	RW	RW
	FSEL_OUT1	PW_OUT1.6	PW_OUT1.5	PW_OUT1.4	PW_OUT1.3	PW_OUT1.2	PW_OUT1.1	PW_OUT1.0
	D7	D6	D5	D4	D3	D2	D1	D0
	RW	RW	RW	RW	RW	RW	RW	RW
FSEL_OUT2	PW_OUT2.6	PW_OUT2.5	PW_OUT2.4	PW_OUT2.3	PW_OUT2.2	PW_OUT2.1	PW_OUT2.0	

PWM_OUT3/4	D15	D14	D13	D12	D11	D10	D9	D8
	RW	RW	RW	RW	RW	RW	RW	RW
	FSEL_OUT3	PW_OUT3.6	PW_OUT3.5	PW_OUT3.4	PW_OUT3.3	PW_OUT3.2	PW_OUT3.1	PW_OUT3.0
	D7	D6	D5	D4	D3	D2	D1	D0
	RW	RW	RW	RW	RW	RW	RW	RW
FSEL_OUT4	PW_OUT4.6	PW_OUT4.5	PW_OUT4.4	PW_OUT4.3	PW_OUT4.2	PW_OUT4.1	PW_OUT4.0	

PWM_LS	D15	D14	D13	D12	D11	D10	D9	D8
	RW	RW	RW	RW	RW	RW	RW	RW
	FSEL_LS1	PW_LS1.6	PW_LS1.5	PW_LS1.4	PW_LS1.3	PW_LS1.2	PW_LS1.1	PW_LS1.0
	D7	D6	D5	D4	D3	D2	D1	D0
	RW	RW	RW	RW	RW	RW	RW	RW
FSEL_LS2	PW_LS2.6	PW_LS2.5	PW_LS2.4	PW_LS2.3	PW_LS2.2	PW_LS2.1	PW_LS2.0	

STATUS_0	D15	D14	D13	D12	D11	D10	D9	D8
	R	R	R	R/RC	R/RC	R/RC	R/RC	R/RC
	OPMOD.1	OPMOD.0	COLD_START	WU_TIM	WU_LIN	WU_CAN	WU_WU3	WU_WU2
	D7	D6	D5	D4	D3	D2	D1	D0
	R/RC	R	R	R	R	R/RC	R/RC	R/RC
WU_WU1	WD_CNT.3	WD_CNT.2	WD_CNT.1	WD_CNT.0	VR1_RES.2	VR1_RES.1	VR1_RES.0	

NCV7462

SPI REGISTERS OVERVIEW

STATUS_1	D15	D14	D13	D12	D11	D10	D9	D8
	N/A	R	R	R	R/RC	R	R/RC	R/RC
	reserved	WU3	WU2	WU1	VCAN_FAIL	VCAN_UV	VR1_FAIL	VR2_FAIL
	D7	D6	D5	D4	D3	D2	D1	D0
	R/RC	R/RC	R/RC	R/RC	R/RC	R/RC	R/RC	R/RC
	VR2_SHORT	VS_OV	VS_UV	TSD2	TSD1	TWAR	TO_TXDL	TO_TXDC

STATUS_2	D15	D14	D13	D12	D11	D10	D9	D8
	N/A	N/A	R	R	R/RC	R/RC	R/RC	R/RC
	reserved	reserved	WD_STATUS.1	WD_STATUS.0	LS2_OC	LS1_OC	OUT_HS_OC	OUT4_OC
	D7	D6	D5	D4	D3	D2	D1	D0
	R/RC	R/RC	R/RC	R/RC	R/RC	R/RC	R/RC	R/RC
	OUT3_OC	OUT2_OC	OUT1_OC	OUT_HS_UL	OUT4_UL	OUT3_UL	OUT2_UL	OUT1_UL

NCV7462

SPI REGISTERS DETAILS

CONTROL_0

CONTROL_0	D15	D14	D13	D12	D11	D10	D9	D8
	RW	RW	RW	RW	RW	RW	RW	RW
	MOD_STBY	MOD_SLEEP	WD_TRIG	WD_PER.1	WD_PER.0	ICMP_STBY	VR2_ON.1	VR2_ON.0
	D7	D6	D5	D4	D3	D2	D1	D0
	RW	RW	RW	RW	RW	RW	RW	RW
VR1_RES.1	VR1_RES.0	CAN_DIS	CAN_LSTO	LIN_SLOPE	TXDL_TO.1	TXDL_TO.0	FSO_DIS	

Mode Control	MOD_STBY	MOD_SLEEP		
	0	0	default	Normal Mode
	0	1		Go to Sleep Mode
	1	0		Go to Standby Mode
	1	1		Go to Sleep Mode (dominant)

Watchdog Trigger Bit	WD_TRIG		
	0		Watchdog trigger set to 0
	1		Watchdog trigger set to 1

Watchdog Trigger Time	WD_PER.1	WD_PER.0		Configuration of the Watchdog Trigger Time
	0	0	default	Trigger time = 9.75 ms
	0	1		Trigger time = 39 ms
	1	0		Trigger time = 97.5 ms
	1	1		Trigger time = 195 ms

Standby VR1 Comparator	ICMP_STBY		Disables the VR1 Current Comparator
	0	default	Comparator is Enabled
	1		Comparator is Disabled

VR2 Control	VR2_ON.1	VR2_ON.0		VR2 Behavior in Different Modes
	0	0	default	VR2 is off in all modes
	0	1		VR2 is on in normal mode; off in standby and sleep modes
	1	0		VR2 is on in normal and standby mode; off in sleep mode
	1	1		VR2 is on in all modes

VR1 Reset Level	VR1_RES.1	VR1_RES.0		Adjustment of the VR1 Reset Level
	0	0	default	Set the reset threshold to typ. 4.5 V (91%)
	0	1		Set the reset threshold to typ. 4.3 V (87%)
	1	0		Set the reset threshold to typ. 3.9 V (79%)
	1	1		Set the reset threshold to typ. 3.7 V (74%)

NCV7462

CAN Transceiver Control	CAN_DIS	CAN_LSTO		CAN Transceiver In Normal Mode
	0	0	default	CAN Transmitter and Receiver Enabled
	0	1		CAN Listen Only (Transmitter will not react to TxDC signal)
	1	X		CAN Transceiver Disabled

LIN Slope Control	LIN_SLOPE		Change of the LIN Slope
	0	default	High slew rate (as per LIN specification)
	1		Low slew rate

TxDL Time-out Timer	TxDL_TO.1	TxDL_TO.0		Dominant TxD Time-out Configuration of the LIN Interface
	0	0	default	Set the timer to typ. 55 ms
	0	1		Set the timer to typ. 13 ms
	1	X		Time-out timer disabled

FSO Function Disable	FSO_DIS		OUT3/FSO Function
	0	default	OUT3 pin is driven by internal FSO signal
	1		OUT3 pins is a general-purpose high-side driver

CONTROL_1

CONTROL_1	D15	D14	D13	D12	D11	D10	D9	D8
	RW	RW	RW	RW	RW	RW	RW	RW
	WU_CAN_DIS	WU_LIN_DIS	WU_TIM_EN.1	WU_TIM_EN.0	WU3_DIS	WU2_DIS	WU1_DIS	WU3_PUD
	D7	D6	D5	D4	D3	D2	D1	D0
	RW	RW	RW	RW	RW	RW	RW	RW
	WU2_PUD	WU1_PUD	WU3_T.1	WU3_T.0	WU2_T.1	WU2_T.0	WU1_T.1	WU1_T.0

CAN Wakeup Disable	WU_CAN_DIS		Disables CAN Wakeup in Standby or Sleep Mode
	0	default	CAN Wakeup Enabled
	1		CAN Wakeup Disabled

LIN Wakeup Disable	WU_LIN_DIS		Disables LIN Wakeup in Standby or Sleep Mode
	0	default	LIN Wakeup Enabled
	1		LIN Wakeup Disabled

Timer Wakeup Control	WU_TIM_EN.[1:0]			Enables Cyclic (timer controlled) Wakeup from Standby or Sleep Mode
	0	0	default	Timers 1/2 are not used as wakeup sources
	0	1		Wakeup generated based on Timer 1
	1	0		Wakeup generated based on Timer 2
	1	1		Wakeup generated based on Timer 1

NCV7462

WUx Wakeup Disable	WU3_DIS	WU2_DIS	WU1_DIS		WUx Configuration
	0	0	0	default	All wake-up inputs are enabled
	X	X	1		Input WU1 is disabled as wake-up
	X	1	X		Input WU2 is disabled as wake-up
	1	X	X		Input WU3 is disabled as wake-up

WUx Sink/Source	WU3_PUD	WU2_PUD	WU1_PUD		WUx Sink/Source Configuration
	0	0	0	default	Default: All WUx configured as current sink in all modes
	X	X	1		WU1 configured as current source in Normal mode
	X	1	X		WU2 configured as current source in Normal mode
	1	X	X		WU3 configured as current source in Normal mode

WUx Filter Time	WUx_T.1	WUx_T.0		Defines the Filter configuration for Wake-ups WU1-3
	0	0	default	Default: Filter with 64 μ s filter time (static sense)
	0	1		Enables Filter after 80 μ s with a filter time of 16 μ s (cyclic sensing); Timer2
	1	0		Enables Filter after 800 μ s with a filter time of 16 μ s (cyclic sensing); Timer2
	1	1		Enables Filter after 800 μ s with a filter time of 16 μ s (cyclic sensing); Timer1

CONTROL_2

CONTROL_2	D15	D14	D13	D12	D11	D10	D9	D8
	RW	RW	RW	RW	RW	RW	RW	RW
	reserved	reserved	reserved	reserved	reserved	reserved	reserved	reserved
	D7	D6	D5	D4	D3	D2	D1	D0
	RW	RW	RW	RW	RW	RW	RW	RW
	T2_TPER.1	T2_TPER.0	T2_TON.1	T2_TON.0	T1_TPER.2	T1_TPER.1	T1_TPER.0	T1_TON

Timer2 Period	T2_TPER.1	T2_TPER.0		Defines the Period of the Cyclic Sense Timer2
	0	0	default	Period: 200 ms
	0	1		Period: 50 ms
	1	0		Period: 20 ms
	1	1		Period: 10 ms

Timer2 On-time	T2_TON.1	T2_TON.0		Defines the On Time for the Cyclic Sense Timer2
	0	0	default	ON time 100 μ s
	0	1		ON time 200 μ s
	1	0		ON time 1 ms
	1	1		reserved – if used, will be equal to the default value of 100 μ s

NCV7462

Timer1 Period	T1_TPER.2	T1_TPER.1	T1_TPER.0		Defines the Period of the Cyclic Sense Timer1
	0	0	0	default	Period: 0.5 s
	0	0	1		Period: 1.0 s
	0	1	0		Period: 1.5 s
	0	1	1		Period: 2.0 s
	1	0	0		Period: 2.5 s
	1	0	1		Period: 3.0 s
	1	1	0		Period: 3.5 s
	1	1	1		Period: 4.0 s

Timer1 On-time	T1_TON		Defines the On Time for the Cyclic Sense Timer1
	0	default	ON time 10 ms
	1		ON time 20 ms

CONTROL_3

CONTROL_3	D15	D14	D13	D12	D11	D10	D9	D8
	RW	RW	RW	RW	RW	RW	RW	RW
	reserved	reserved	reserved	reserved	reserved	reserved	reserved	reserved
	D7	D6	D5	D4	D3	D2	D1	D0
	RW	RW	RW	RW	RW	RW	RW	RW
VS_LOCKOUT_DIS	LS_OVUV	LS2_ON.1	LS2_ON.0	LS1_ON.1	LS1_ON.0	INH_OFF	OUT_HS_OCR	

VS UV/OV Lockout	VS_LOCKOUT_DIS		Disables the Automatic VS Lockout
	0	default	Outputs will be reactivated only when the VS UV/OV flag is cleared
	1		Outputs will be reactivated when VS UV/OV condition disappears

LSx Active in VS UV/OV	LS_OVUV		Enables LSx in Case of VS OV/UV
	0	default	Disabled – LSx will be disabled in case of VS UV/OV
	1		Enabled – LSx will remain in their previous state in case of VS UV/OV

LSx Driver Control	LSx_ON.1	LSx_ON.0		Defines the Configuration of the Low-Side LS1/2
	0	0	default	Driver is off in all modes
	0	1		Driver is on in normal mode (off in standby/sleep mode)
	1	0		Driver is controlled by its PWM setting in normal mode
	1	1		reserved – if used, LSx will be off in all modes (equal to default)

Inhibit Output	INH_OFF		LIN Pull-up for Master or Control Output for External Voltage Regulator
	0	default	INH output active in normal mode
	1		INH output off (master resistor disabled)

NCV7462

Overcurrent Recovery OUT_HS	OUT_HS_OCR		Enables Overcurrent Recovery Mode at OUT_HS
	0	default	Overcurrent recovery disabled
	1		Overcurrent recovery enabled

CONTROL_4

CONTROL_4	D15	D14	D13	D12	D11	D10	D9	D8
	RW	RW	RW	RW	RW	RW	RW	RW
	OUT1_LOWR	OUT4_ON.2	OUT4_ON.1	OUT4_ON.0	OUT3_ON.2	OUT3_ON.1	OUT3_ON.0	OUT2_ON.2
	D7	D6	D5	D4	D3	D2	D1	D0
	RW	RW	RW	RW	RW	RW	RW	RW
	OUT2_ON.1	OUT2_ON.0	OUT1_ON.2	OUT1_ON.1	OUT1_ON.0	OUT_HS_ON.2	OUT_HS_ON.1	OUT_HS_ON.0

OUT1 Switch Strength	OUT1_LOWR		Enables Stronger Switch on OUT1 Output
	0	default	"Normal ohmic" configuration: typical 7 Ohm Ron; parameters equal to OUT2-4
	1		"Low ohmic" configuration: typical 2 Ohm Ron; higher underload threshold; higher current limitation

HS Driver Control	OUT_HS_ON.[2:0]				Defines the Configuration of the High-side OUT_HS
	OUTx_ON.[2:0]				Defines the Configuration of the High-side OUT1..4
	0	0	0	default	Driver is off in all modes
	0	0	1		Driver is on in normal, standby and sleep mode
	0	1	0		Driver is cyclic on with the timing of Timer1 in normal, standby and sleep mode
	0	1	1		Driver is cyclic on with the timing of Timer2 in normal, standby and sleep mode
	1	0	0		Driver is controlled by the corresponding PWM unit in normal, cyclic-sense standby / sleep mode
	1	0	1		reserved – if used, the driver is off in all modes (equal to default)
	1	1	0		reserved – if used, the driver is off in all modes (equal to default)
1	1	1		reserved – if used, the driver is off in all modes (equal to default)	

PWM_HS

PWM_HS	D15	D14	D13	D12	D11	D10	D9	D8
	RW	RW	RW	RW	RW	RW	RW	RW
	reserved	reserved	reserved	reserved	reserved	reserved	reserved	reserved
	D7	D6	D5	D4	D3	D2	D1	D0
	RW	RW	RW	RW	RW	RW	RW	RW
	FSEL_HS	PW_HS.6	PW_HS.5	PW_HS.4	PW_HS.3	PW_HS.2	PW_HS.1	PW_HS.0

NCV7462

PWM_OUT1/2

PWM_OUT1/2	D15	D14	D13	D12	D11	D10	D9	D8
	RW	RW	RW	RW	RW	RW	RW	RW
	FSEL_OUT1	PW_OUT1.6	PW_OUT1.5	PW_OUT1.4	PW_OUT1.3	PW_OUT1.2	PW_OUT1.1	PW_OUT1.0
	D7	D6	D5	D4	D3	D2	D1	D0
	RW	RW	RW	RW	RW	RW	RW	RW
	FSEL_OUT2	PW_OUT2.6	PW_OUT2.5	PW_OUT2.4	PW_OUT2.3	PW_OUT2.2	PW_OUT2.1	PW_OUT2.0

PWM_OUT3/4

PWM_OUT3/4	D15	D14	D13	D12	D11	D10	D9	D8
	RW	RW	RW	RW	RW	RW	RW	RW
	FSEL_OUT3	PW_OUT3.6	PW_OUT3.5	PW_OUT3.4	PW_OUT3.3	PW_OUT3.2	PW_OUT3.1	PW_OUT3.0
	D7	D6	D5	D4	D3	D2	D1	D0
	RW	RW	RW	RW	RW	RW	RW	RW
	FSEL_OUT4	PW_OUT4.6	PW_OUT4.5	PW_OUT4.4	PW_OUT4.3	PW_OUT4.2	PW_OUT4.1	PW_OUT4.0

PWM_LS

PWM_LS	D15	D14	D13	D12	D11	D10	D9	D8
	RW	RW	RW	RW	RW	RW	RW	RW
	FSEL_LS1	PW_LS1.6	PW_LS1.5	PW_LS1.4	PW_LS1.3	PW_LS1.2	PW_LS1.1	PW_LS1.0
	D7	D6	D5	D4	D3	D2	D1	D0
	RW	RW	RW	RW	RW	RW	RW	RW
	FSEL_LS2	PW_LS2.6	PW_LS2.5	PW_LS2.4	PW_LS2.3	PW_LS2.2	PW_LS2.1	PW_LS2.0

PWM Frequency	FSEL_HS FSEL_OUTx FSEL_LSx		PWM Frequency Selector
	0	default	Base frequency of PWM on the corresponding output $f(\text{PWM}) = 150 \text{ Hz}$
	1		Base frequency of PWM on the corresponding output $f(\text{PWM}) = 200 \text{ Hz}$

Output Duty Cycle	PW_HS[6:0] PW_OUTx[6:0] PW_LSx[6:0]		Duty Cycle Selector
	0	default	Corresponding output is active with duty cycle 1 / 128
	1 .. \$7F		Corresponding output is active with duty cycle $(\text{PW_xxx}[6:0] + 1) / 128$

STATUS_0

STATUS_0	D15	D14	D13	D12	D11	D10	D9	D8
	R	R	R	R/RC	R/RC	R/RC	R/RC	R/RC
	OPMOD.1	OPMOD.0	COLD_START	WU_TIM	WU_LIN	WU_CAN	WU_WU3	WU_WU2
	D7	D6	D5	D4	D3	D2	D1	D0
	R/RC	R	R	R	R	R/RC	R/RC	R/RC
	WU_WU1	WD_CNT.3	WD_CNT.2	WD_CNT.1	WD_CNT.0	VR1_RES.2	VR1_RES.1	VR1_RES.0

NCV7462

Operating Mode	OPMOD.1	OPMOD.0	Operating Mode
	0	0	Standby
	0	1	Normal
	1	0	Flash
	1	1	reserved – will not be used

Cold Start	COLD_START	Power on Reset Status
	0	Cold start (=VS connection) not occurred
1	Cold start (=VS connection) occurred – cleared after first successful access of the register	

Wake-up Source Recognition	WU_TIM	WU_LIN	WU_CAN	Remote Wake-up Source
	0	0	0	no timer, CAN nor LIN wakeup occurred
	X	X	1	CAN wake-up occurred
	X	1	X	LIN wake-up occurred
	1	X	X	Timer wakeup occurred

Wake-up Source Recognition	WU_WUx	Local Wake-up Source (Wux Pins)
	0	No WUx pin wake-up occurred
1	WUx pin wake-up occurred	

Watchdog Failure Counter	WD_CNT.[3:0]	Number of Watchdog Failures
	0	default
	\$1 .. \$F	Non-zero number of watchdog failures encountered

VR1 Restart Counter	VR1_RES.[2:0]	Number of Unsuccessful Restarts of VR1 After Thermal Shutdown
	0	default
	\$1 .. \$7	Non-zero number of unsuccessful VR1 restarts encountered

STATUS_1

STATUS_1	D15	D14	D13	D12	D11	D10	D9	D8
	N/A	R	R	R	R/RC	R	R/RC	R/RC
	reserved	WU3	WU2	WU1	VCAN_FAIL	VCAN_UV	VR1_FAIL	VR2_FAIL
	D7	D6	D5	D4	D3	D2	D1	D0
	R/RC	R/RC	R/RC	R/RC	R/RC	R/RC	R/RC	R/RC
	VR2_SHORT	VS_OV	VS_UV	TSD2	TSD1	TWAR	TO_TXDL	TO_TXDC

Status of WUx Inputs	WUx	Status of Wux Input in Normal Mode
	0	WUx is Low
1	WUx is High	

NCV7462

VCAN Failure	VCAN_FAIL		VCC_CAN Supply Input Failure
	0	default	no VCC_CAN failure occurred
	1		VCC_CAN fails for at least 2 μ s (VCC_CAN < Vfail_VCAN for > 2 μ s), latched bit

VCAN Undervoltage	VCAN_UV		VCC_CAN Supply Input Undervoltage
	0	default	no VCC_CAN failure occurred
	1		VCC_CAN < Vfail_VCAN

VR1 Failure	VR1_FAIL		Voltage Regulator VR1 Failure
	0	default	no VR1 failure occurred
	1		VR1 fails for at least 5 μ s (VR1 < 2 V for > 5 μ s) OR (VR1 < 2 V at 4 ms after turn-on)

VR2 Failure	VR2_FAIL		Voltage Regulator VR2 Failure
	0	default	No VR2 failure occurred
	1		VR2 fails for at least 2 μ s (VR2 < 2 V for > 2 μ s) OR (VR2 < 2 V at 4 ms after turn-on)

VR2 Short Circuit	VR2_SHORT		Indicates a Short Circuit at VR2
	0	default	No short circuit
	1		VR2 short to GND at turn on; (VR2 < 2 V for more than 4 ms)

VS Overvoltage	VS_OV		Overvoltage on VS Pin
	0	default	VS is below the overvoltage limit
	1		VS exceeded the overvoltage limit

VS Undervoltage	VS_UV		Undervoltage on VS Pin
	0	default	VS is above the undervoltage limit
	1		VS fell below the undervoltage limit

Thermal Protection	TSD2	TSD1	TWAR		Thermal Warning/Shutdown
	0	0	0	default	No thermal limit exceeded
	X	X	1		Thermal warning encountered
	X	1	X		Thermal shutdown 1 encountered
	1	X	X		Thermal shutdown 2 encountered

Permanent Dominant Protection	TO_TxDL	TO_TxDC		
	0	0	default	No transmitter timeout encountered
	1	X		LIN transmitter timeout encountered
	X	1		CAN transmitter timeout encountered

NCV7462

STATUS_2

STATUS_2	D15	D14	D13	D12	D11	D10	D9	D8
	N/A	N/A	R	R	R/RC	R/RC	R/RC	R/RC
	reserved	reserved	WD_STATUS.1	WD_STATUS.0	LS2_OC	LS1_OC	OUT_HS_OC	OUT4_OC
	D7	D6	D5	D4	D3	D2	D1	D0
	R/RC	R/RC	R/RC	R/RC	R/RC	R/RC	R/RC	R/RC
	OUT3_OC	OUT2_OC	OUT1_OC	OUT_HS_UL	OUT4_UL	OUT3_UL	OUT2_UL	OUT1_UL

Watchdog Counter Status	WD_STATUS.[1:0]		Watchdog Counter Status
	0	0	Watchdog counter below 33% of acceptable interval*
	0	1	Watchdog counter above 33% and below 66% of acceptable interval*
	1	0	Reserved – will not be used
	1	1	Watchdog counter above 66% of acceptable interval*
* acceptable interval means timeout or open window interval			

Driver Overcurrent	LSx_OC OUT_HS_OC OUT_x_OC		Overcurrent Status of the Corresponding Output
	0	default	No overcurrent encountered
	1		Overcurrent encountered

Driver Underload	OUT_HS_UL OUT_x_UL		Underload Status of the Corresponding Output
	0	default	No underload encountered
	1		Underload encountered

DEVICE ORDERING INFORMATION

Part Number	Package Type	Shipping [†]
NCV7462DQ0R2G	SSOP36-EP (Pb-Free)	1500 / Tape & Reel (24 mm Tape)
NCV7462DQ1R2G	SSOP36-EP (Pb-Free)	1500 / Tape & Reel (24 mm Tape)

[†]For information on tape and reel specifications, including part orientation and tape sizes, please refer to our Tape and Reel Packaging Specifications Brochure, BRD8011/D.

MECHANICAL CASE OUTLINE

PACKAGE DIMENSIONS

ON Semiconductor®

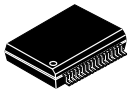

SCALE 1:1

SSOP36 EP
CASE 940AB
ISSUE A

DATE 19 JAN 2016

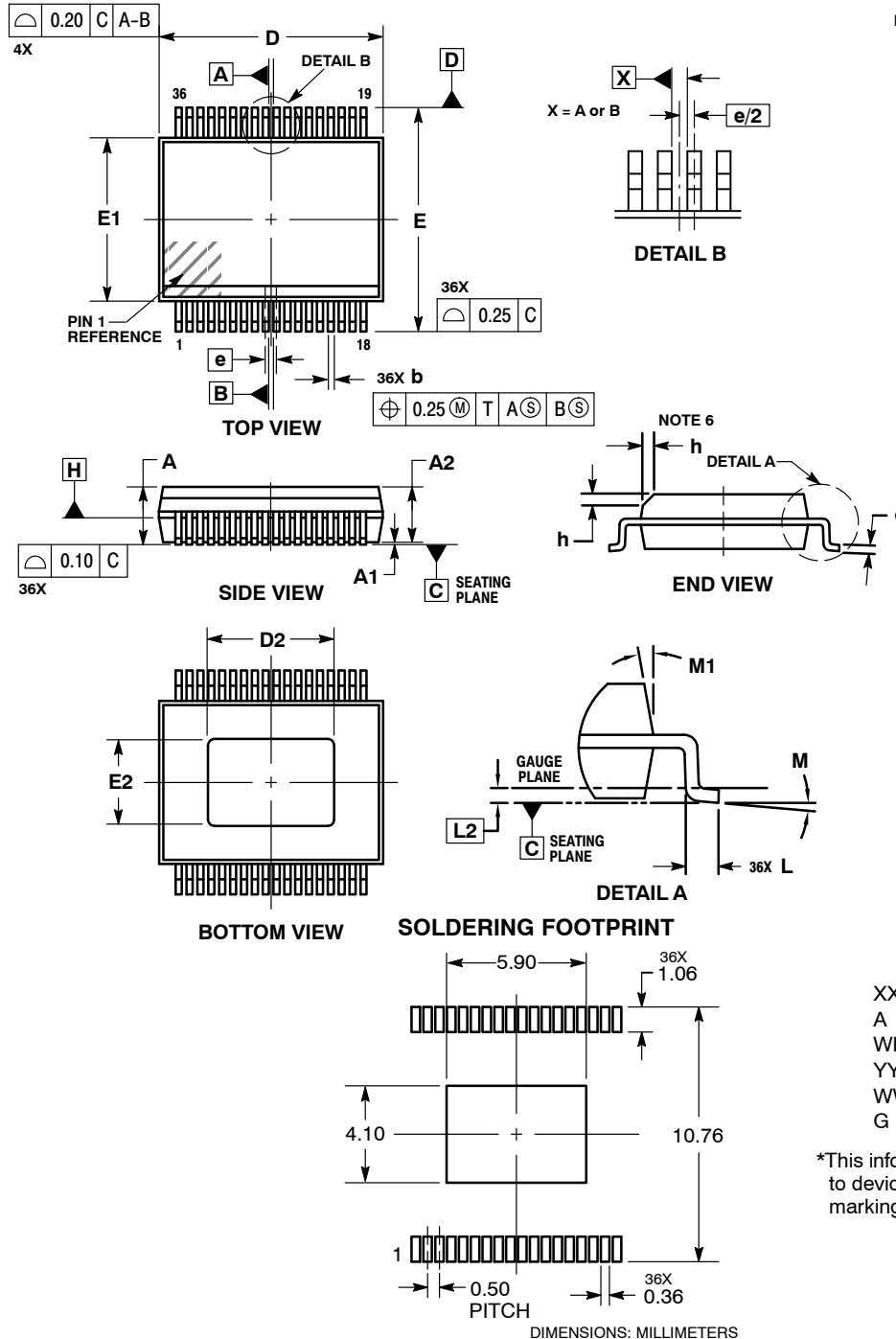

NOTES:

1. DIMENSIONING AND TOLERANCING PER ASME Y14.5M, 1994.
2. CONTROLLING DIMENSION: MILLIMETERS.
3. DIMENSION b DOES NOT INCLUDE DAMBAR PROTRUSION. ALLOWABLE DAMBAR PROTRUSION SHALL BE 0.13 TOTAL IN EXCESS OF THE b DIMENSION AT MMC.
4. DIMENSION b SHALL BE MEASURED BETWEEN 0.10 AND 0.25 FROM THE TIP.
5. DIMENSIONS D AND E1 DO NOT INCLUDE MOLD FLASH, PROTRUSIONS OR GATE BURRS. DIMENSIONS D AND E1 SHALL BE DETERMINED AT DATUM H.
6. THIS CHAMFER FEATURE IS OPTIONAL. IF IT IS NOT PRESENT, A PIN ONE IDENTIFIER MUST BE LOCATED WITHIN THE INDICATED AREA.

MILLIMETERS		
DIM	MIN	MAX
A	---	2.65
A1	---	0.10
A2	2.15	2.60
b	0.18	0.30
c	0.23	0.32
D	10.30 BSC	
D2	5.70	5.90
E	10.30 BSC	
E1	7.50 BSC	
E2	3.90	4.10
e	0.50 BSC	
h	0.25	0.75
L	0.50	0.90
L2	0.25 BSC	
M	0°	8°
M1	5°	15°

GENERIC MARKING DIAGRAM*

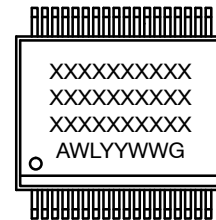

- XXXX = Specific Device Code
- A = Assembly Location
- WL = Wafer Lot
- YY = Year
- WW = Work Week
- G = Pb-Free Package

*This information is generic. Please refer to device data sheet for actual part marking.

DOCUMENT NUMBER:	98AON46215E	Electronic versions are uncontrolled except when accessed directly from the Document Repository. Printed versions are uncontrolled except when stamped "CONTROLLED COPY" in red.
DESCRIPTION:	SSOP36 EXPOSED PAD	PAGE 1 OF 1

ON Semiconductor and ON are trademarks of Semiconductor Components Industries, LLC dba ON Semiconductor or its subsidiaries in the United States and/or other countries. ON Semiconductor reserves the right to make changes without further notice to any products herein. ON Semiconductor makes no warranty, representation or guarantee regarding the suitability of its products for any particular purpose, nor does ON Semiconductor assume any liability arising out of the application or use of any product or circuit, and specifically disclaims any and all liability, including without limitation special, consequential or incidental damages. ON Semiconductor does not convey any license under its patent rights nor the rights of others.

onsemi, **Onsemi**, and other names, marks, and brands are registered and/or common law trademarks of Semiconductor Components Industries, LLC dba "**onsemi**" or its affiliates and/or subsidiaries in the United States and/or other countries. **onsemi** owns the rights to a number of patents, trademarks, copyrights, trade secrets, and other intellectual property. A listing of **onsemi**'s product/patent coverage may be accessed at www.onsemi.com/site/pdf/Patent-Marking.pdf. **onsemi** reserves the right to make changes at any time to any products or information herein, without notice. The information herein is provided "as-is" and **onsemi** makes no warranty, representation or guarantee regarding the accuracy of the information, product features, availability, functionality, or suitability of its products for any particular purpose, nor does **onsemi** assume any liability arising out of the application or use of any product or circuit, and specifically disclaims any and all liability, including without limitation special, consequential or incidental damages. Buyer is responsible for its products and applications using **onsemi** products, including compliance with all laws, regulations and safety requirements or standards, regardless of any support or applications information provided by **onsemi**. "Typical" parameters which may be provided in **onsemi** data sheets and/or specifications can and do vary in different applications and actual performance may vary over time. All operating parameters, including "Typicals" must be validated for each customer application by customer's technical experts. **onsemi** does not convey any license under any of its intellectual property rights nor the rights of others. **onsemi** products are not designed, intended, or authorized for use as a critical component in life support systems or any FDA Class 3 medical devices or medical devices with a same or similar classification in a foreign jurisdiction or any devices intended for implantation in the human body. Should Buyer purchase or use **onsemi** products for any such unintended or unauthorized application, Buyer shall indemnify and hold **onsemi** and its officers, employees, subsidiaries, affiliates, and distributors harmless against all claims, costs, damages, and expenses, and reasonable attorney fees arising out of, directly or indirectly, any claim of personal injury or death associated with such unintended or unauthorized use, even if such claim alleges that **onsemi** was negligent regarding the design or manufacture of the part. **onsemi** is an Equal Opportunity/Affirmative Action Employer. This literature is subject to all applicable copyright laws and is not for resale in any manner.

PUBLICATION ORDERING INFORMATION

LITERATURE FULFILLMENT:

Email Requests to: orderlit@onsemi.com

onsemi Website: www.onsemi.com

TECHNICAL SUPPORT

North American Technical Support:

Voice Mail: 1 800-282-9855 Toll Free USA/Canada

Phone: 011 421 33 790 2910

Europe, Middle East and Africa Technical Support:

Phone: 00421 33 790 2910

For additional information, please contact your local Sales Representative

X-ON Electronics

Largest Supplier of Electrical and Electronic Components

Click to view similar products for [CAN Interface IC category](#):

Click to view products by [ON Semiconductor manufacturer](#):

Other Similar products are found below :

[416694H](#) [MAX33041EASA+T](#) [TJA1042T,118](#) [IL41050TA-1E](#) [TJA1042T1J](#) [TJA1042T31J](#) [SN65LBC031DG4](#) [TJA1050T/CM,118](#)
[MAX13051ESA+T](#) [SJA1000T/N1.118](#) [MCP2562FD-EP](#) [MCP2561FD-EP](#) [LTM2889IY-5#PBF](#) [ADM3053BRWZ-REEL7](#) [ADM3051CRZ-](#)
[REEL7](#) [ADM3052BRWZ-REEL7](#) [IA82527PLC44AR2](#) [LT3960JMSE#PBF](#) [TJA1040TCM,118](#) [TD041SCANH](#) [TDH541SCANH](#)
[SIT1050TK](#) [SIT1040TK](#) [MCP25625-ESS](#) [MAX3053ESA+T](#) [MAX13041ASDV](#) [MAX3057ASA+T](#) [MCP2515T-I/ST](#) [MAX13051ASA+](#)
[MCP2517FD-H/SL](#) [NCV7341D21R2G](#) [MC33897CTEFR2](#) [MAX3056ASD+](#) [MAX3054ASD+](#) [MAX3055ASD+](#) [MAX3051ESA+T](#)
[MCP2510-I/P](#) [MCP2510-I/SO](#) [MCP2510-I/ST](#) [MCP2515-E/SO](#) [MCP2515-I/P](#) [MCP2515-I/SO](#) [MCP2515-I/ST](#) [MCP2515T-I/SO](#) [MCP2551-](#)
[E/P](#) [MCP2551-E/SN](#) [MCP2551-I/P](#) [MCP2551-I/SN](#) [MCP2561-E/P](#) [MCP2561FD-HP](#)