

# ON Semiconductor

## Is Now

# onsemi™

To learn more about onsemi™, please visit our website at  
[www.onsemi.com](http://www.onsemi.com)

---

**onsemi** and **onsemi** and other names, marks, and brands are registered and/or common law trademarks of Semiconductor Components Industries, LLC dba "**onsemi**" or its affiliates and/or subsidiaries in the United States and/or other countries. **onsemi** owns the rights to a number of patents, trademarks, copyrights, trade secrets, and other intellectual property. A listing of **onsemi** product/patent coverage may be accessed at [www.onsemi.com/site/pdf/Patent-Marking.pdf](http://www.onsemi.com/site/pdf/Patent-Marking.pdf). **onsemi** reserves the right to make changes at any time to any products or information herein, without notice. The information herein is provided "as-is" and **onsemi** makes no warranty, representation or guarantee regarding the accuracy of the information, product features, availability, functionality, or suitability of its products for any particular purpose, nor does **onsemi** assume any liability arising out of the application or use of any product or circuit, and specifically disclaims any and all liability, including without limitation special, consequential or incidental damages. Buyer is responsible for its products and applications using **onsemi** products, including compliance with all laws, regulations and safety requirements or standards, regardless of any support or applications information provided by **onsemi**. "Typical" parameters which may be provided in **onsemi** data sheets and/or specifications can and do vary in different applications and actual performance may vary over time. All operating parameters, including "Typicals" must be validated for each customer application by customer's technical experts. **onsemi** does not convey any license under any of its intellectual property rights nor the rights of others. **onsemi** products are not designed, intended, or authorized for use as a critical component in life support systems or any FDA Class 3 medical devices or medical devices with a same or similar classification in a foreign jurisdiction or any devices intended for implantation in the human body. Should Buyer purchase or use **onsemi** products for any such unintended or unauthorized application, Buyer shall indemnify and hold **onsemi** and its officers, employees, subsidiaries, affiliates, and distributors harmless against all claims, costs, damages, and expenses, and reasonable attorney fees arising out of, directly or indirectly, any claim of personal injury or death associated with such unintended or unauthorized use, even if such claim alleges that **onsemi** was negligent regarding the design or manufacture of the part. **onsemi** is an Equal Opportunity/Affirmative Action Employer. This literature is subject to all applicable copyright laws and is not for resale in any manner. Other names and brands may be claimed as the property of others.

# LDO Regulator with RESET and Delay Time Select, Ultra Low $I_q$ , 150 mA



ON Semiconductor®

[www.onsemi.com](http://www.onsemi.com)

## NCV8760C

The NCV8760C is a precision ultra low  $I_q$  low dropout voltage regulator. Quiescent currents as low as 18  $\mu\text{A}$  typical make it ideal for automotive applications requiring low quiescent current. Integrated control features such as Reset and Delay Time Select make it ideal for powering microprocessors.

It is available with a fixed output voltage of 5.0 V and 3.3 V and regulates within  $\pm 2.0\%$ .

### Features

- Output Voltage Options: 3.3 V and 5 V
- Output Voltage Accuracy:  $\pm 2.0\%$
- Output Current up to 150 mA
- Microprocessor Compatible Control Functions:
  - ◆ Delay Time Select
  - ◆ RESET Output
- Low Dropout Voltage
- Ultra Low Quiescent Current of 18  $\mu\text{A}$  Typical
- Protection Features:
  - ◆ Thermal Shutdown
  - ◆ Current Limitation
- NCV Prefix for Automotive and Other Applications Requiring Unique Site and Control Change Requirements; AEC-Q100 Qualified and PPAP Capable
- EMC Compliant
- These Devices are Pb-Free and RoHS Compliant

### Applications (for safety applications refer to Figure 29)

- Automotive:
  - ◆ Body Control Module
  - ◆ Instruments and Clusters
  - ◆ Occupant Protection and Comfort
  - ◆ Conventional Powertrain
- Battery Powered Consumer Electronics

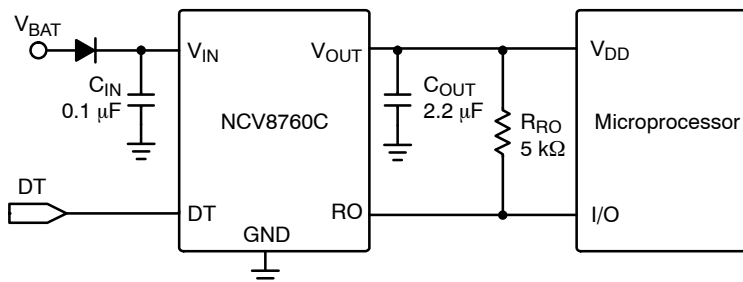
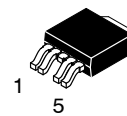
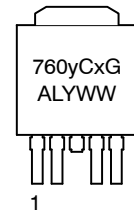

Figure 1. Application Diagram

### MARKING DIAGRAMS



DPAK 5-PIN  
DT SUFFIX  
CASE 175AA



- x = 5 for 5 V Output, 3 for 3.3 V Output
- y = 1 for 8 ms, 128 ms Reset Delay, 2 for 8 ms, 32 ms Reset Delay, 3 for 16 ms, 64 ms Reset Delay, 4 for 32 ms, 128 ms Reset Delay
- A = Assembly Location
- L = Wafer Lot
- Y = Year
- WW = Work Week
- G = Pb-Free Package

### ORDERING INFORMATION

See detailed ordering and shipping information in the dimensions section on page 13 of this data sheet.

# NCV8760C

## PIN CONNECTIONS

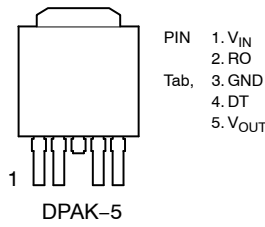

**Figure 2. Pin Connections**

## PIN DESCRIPTIONS

Pin	Symbol	Function
1	$V_{IN}$	Input Supply Voltage. Connect a 0.1 $\mu\text{F}$ bypass capacitor to GND at the IC.
2	RO	Reset Output. Open Drain connected to the $V_{OUT}$ via an internal 30 k $\Omega$ pull-up resistor. Goes low when $V_{OUT}$ drops by more than 7% from its nominal level.
3, Tab	GND	Ground
4	DT	Reset Delay Time Select. Short to GND or connect to $V_{OUT}$ to reset delay select time value. (See DETAILED OPERATING DESCRIPTION)
5	$V_{OUT}$	Regulated Voltage Output. Connect a 2.2 $\mu\text{F}$ capacitor to ground for typical applications.

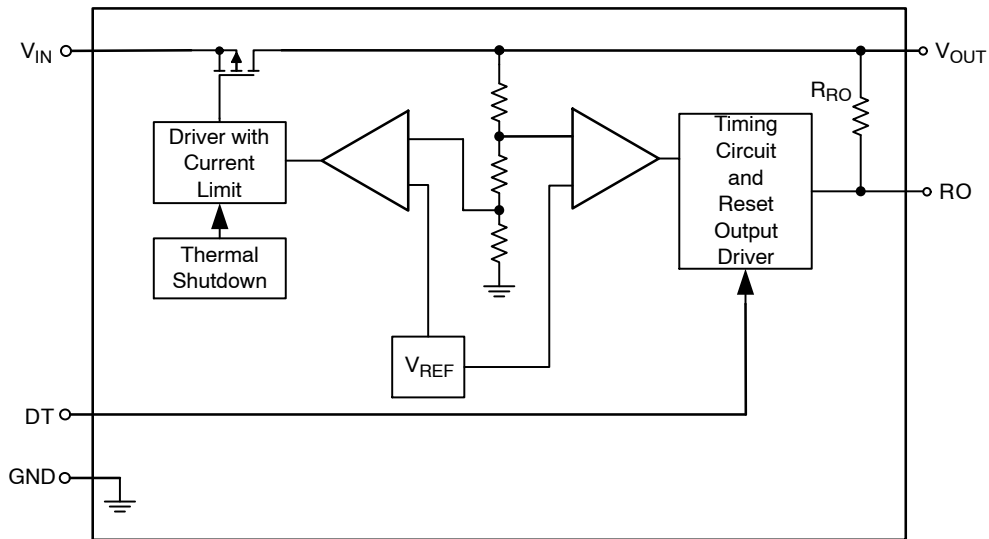

**Figure 3. Block Diagram**

# NCV8760C

## ABSOLUTE MAXIMUM RATINGS

Rating	Symbol	Min	Max	Unit
Input Voltage (Note 1) DC	$V_{IN}$	-0.3	40	V
Input Voltage (Note 2) Load Dump – Suppressed	$V_{IN}$	-	45	V
Output Voltage	$V_{OUT}$	-0.3	7.0	V
DT (Reset Delay Time Select) Voltage	$V_{DT}$	-0.3	7.0	V
Reset Output Voltage	$V_{RO}$	-0.3	7.0	V
Junction Temperature Range	$T_J$	-40	150	°C
Storage Temperature Range	$T_{STG}$	-55	150	°C

Stresses exceeding those listed in the Maximum Ratings table may damage the device. If any of these limits are exceeded, device functionality should not be assumed, damage may occur and reliability may be affected.

1. Refer to ELECTRICAL CHARACTERISTICS and APPLICATION INFORMATION for Safe Operating Area.
2. Load Dump Test B (with centralized load dump suppression) according to ISO16750-2 standard. Guaranteed by design. Not tested in production. Passed Class B according to ISO16750-1.

## ESD CAPABILITY (Note 3)

Rating	Symbol	Min	Max	Unit
ESD Capability, Human Body Model	$ESD_{HBM}$	-4.0	4.0	kV
ESD Capability, Charged Device Model	$ESD_{CDM}$	-1.0	1.0	kV

3. This device series incorporates ESD protection and is tested by the following methods:  
 ESD HBM tested per AEC-Q100-002 (JS-001-2017).  
 Field Induced Charge Device Model ESD characterization is not performed on plastic molded packages with body sizes 2x2 mm due to the inability of a small package body to acquire and retain enough charge to meet the minimum CDM discharge current waveform characteristic defined in JEDEC JS-002-2018.

## LEAD SOLDERING TEMPERATURE AND MSL (Note 4)

Rating	Symbol	Value	Unit
Moisture Sensitivity Level DPAK 5	MSL	1	-

4. For more information, please refer to our Soldering and Mounting Techniques Reference Manual, SOLDERRM/D.

## THERMAL CHARACTERISTICS

Rating	Symbol	Value	Unit
Thermal Characteristics, DPAK-5 (Note 1)			°C/W
Thermal Resistance, Junction-to-Air (Note 5)	$R_{\theta JA}$	47	
Thermal Reference, Junction-to-Top Case (Note 5)	$R_{\psi JC}$	9.1	
Thermal Resistance, Junction-to-Air (Note 6)	$R_{\theta JA}$	28	
Thermal Reference, Junction-to-Top Case (Note 6)	$R_{\psi JC}$	7.4	

5. Values based on 1s0p copper area of 645 mm<sup>2</sup> (or 1 in<sup>2</sup>) of 1 oz. copper thickness and FR4 PCB substrate. Single layer according to JEDEC51.3.
6. Values based on 2s2p copper area of 645 mm<sup>2</sup> (or 1 in<sup>2</sup>) of 1 oz. copper thickness and FR4 PCB substrate. 4 layer according to JEDEC51.7.

## RECOMMENDED OPERATING RANGES (Note 1)

Rating	Symbol	Min	Max	Unit
Input Voltage (Note 7)	$V_{IN}$	4.5	40	V
Junction Temperature Range	$T_J$	-40	150	°C

Functional operation above the stresses listed in the Recommended Operating Ranges is not implied. Extended exposure to stresses beyond the Recommended Operating Ranges limits may affect device reliability.

7. Minimum  $V_{IN} = 4.5 \text{ V}$  or  $(V_{OUT} + V_{DO})$ , whichever is higher.

# NCV8760C

## ELECTRICAL CHARACTERISTICS

( $V_{IN} = 13.5\text{ V}$ ,  $C_{IN} = 0.1\ \mu\text{F}$ ,  $C_{OUT} = 2.2\ \mu\text{F}$ , Min and Max values are valid for temperature range  $-40^{\circ}\text{C} \leq T_J \leq 150^{\circ}\text{C}$  unless noted otherwise and are guaranteed by test, design or statistical correlation. Typical values are referenced to  $T_J = 25^{\circ}\text{C}$ ) (Note 8)

Parameter	Test Conditions	Symbol	Min	Typ	Max	Unit
-----------	-----------------	--------	-----	-----	-----	------

### Regulator Output

Output Voltage (Accuracy %)	5.0 V 3.3 V	$V_{IN} = 5.7\text{ V to }16\text{ V}$ , $I_{OUT} = 0\text{ mA to }150\text{ mA}$ $V_{IN} = 5.55\text{ V to }40\text{ V}$ , $I_{OUT} = 0\text{ mA to }100\text{ mA}$ $V_{IN} = 4.5\text{ V to }16\text{ V}$ , $I_{OUT} = 0\text{ mA to }150\text{ mA}$ $V_{IN} = 4.5\text{ V to }40\text{ V}$ , $I_{OUT} = 0\text{ mA to }100\text{ mA}$	$V_{OUT}$	4.9 4.9 3.234 3.234	5.0 5.0 3.3 3.3	5.1 5.1 3.366 3.366	V
Line Regulation	$V_{IN} = 6\text{ V to }28\text{ V}$ , $I_{OUT} = 5\text{ mA}$	Reg <sub>LINE</sub>	-20	0	20	mV	
Load Regulation	$I_{OUT} = 0.1\text{ mA to }150\text{ mA}$	Reg <sub>LOAD</sub>	-40	10	40	mV	
Dropout Voltage (Note 9)	5.0 V $I_{OUT} = 100\text{ mA}$ $I_{OUT} = 150\text{ mA}$	$V_{DO}$	- -	125 200	300 450	mV	

### Quiescent Current

Quiescent Current, $I_Q = I_{IN} - I_{OUT}$	$I_{OUT} = 0\text{ mA}$ , $T_J = 25^{\circ}\text{C}$ $I_{OUT} = 0\text{ mA}$ , $T_J \leq 125^{\circ}\text{C}$ $I_{OUT} = 0.1\text{ mA}$ , $T_J = 25^{\circ}\text{C}$ $I_{OUT} = 0.1\text{ mA}$ , $T_J \leq 125^{\circ}\text{C}$	$I_Q$	- - - -	18 - 20 -	21 23 24 26	$\mu\text{A}$
---	--	-------	------------------	--------------------	----------------------	---------------

### Current Limit Protection

Current Limit	$V_{OUT} = 0.96 \times V_{OUT\_NOM}$	$I_{LIM}$	205	-	525	mA
Short Circuit Current Limit	$V_{OUT} = 0\text{ V}$	$I_{SC}$	205	-	525	mA

### PSRR

Power Supply Ripple Rejection	$f = 100\text{ Hz}$ , $0.5\text{ V}_{P-P}$	PSRR	-	70	-	dB
-------------------------------	--	------	---	----	---	----

### DT (Reset Delay Time Select)

DT Threshold Voltage Logic Low Logic High		$V_{TH(DT)}$	- 2.0	- -	0.8 -	V
DT Input Current	$V_{DT} = 5\text{ V}$	$I_{DT}$	-	-	1.0	$\mu\text{A}$

### Reset Output RO

Input Voltage Reset Threshold	3.3 V $V_{IN}$ decreasing, $V_{OUT} > V_{RT}$	$V_{IN\_RT}$	-	3.8	4.25	V
Output Voltage Reset Threshold	$V_{OUT}$ decreasing	$V_{RT}$	90	93	96	$\%V_{OUT\_NOM}$
Reset Hysteresis		$V_{RH}$	-	2.0	-	$\%V_{OUT\_NOM}$
Reset Output Low Voltage	$V_{OUT} < V_{RT}$ , $I_{RO} = -1\text{ mA}$	$V_{ROL}$	-	0.2	0.4	V
Reset Output High Voltage		$V_{ROH}$	$V_{OUT} - 0.4$	$V_{OUT} - 0.2$	-	V
Integrated Reset Pull Up Resistor		$R_{RO}$	15	30	50	k $\Omega$
Reset Reaction Time	$V_{OUT}$ into UV to RESET Low	$t_{RR}$	16	25	38	$\mu\text{s}$

### RESET Delay with DT Selection

Reset Time Out of RESET 8 ms version 16 ms version 32 ms version 64 ms version 128 ms version	$V_{OUT}$ into regulation to RO High	$t_{RDx}$	5.0 10 20 40 80	8.0 16 32 64 128	11.5 23 46 92 184	ms
--	--------------------------------------	-----------	-----------------------------	------------------------------	-------------------------------	----

### Thermal Shutdown (Note 10)

Thermal Shutdown Temperature		$T_{SD}$	150	175	195	$^{\circ}\text{C}$
Thermal Shutdown Hysteresis		$T_{SH}$	-	10	-	$^{\circ}\text{C}$

Product parametric performance is indicated in the Electrical Characteristics for the listed test conditions, unless otherwise noted. Product performance may not be indicated by the Electrical Characteristics if operated under different conditions.

- Performance guaranteed over the indicated operating temperature range by design and/or characterization tested at  $T_A \sim T_J$ . Low duty cycle pulse techniques are used during testing to maintain the junction temperature as close to ambient as possible.
- Measured when output voltage falls 100 mV below the regulated voltage at  $V_{IN} = 13.5\text{ V}$ . If  $V_{OUT} < 5\text{ V}$ , then  $V_{DO} = V_{IN} - V_{OUT}$ . Maximum dropout voltage value is limited by minimum input voltage  $V_{IN} = 4.5\text{ V}$  recommended for guaranteed operation at maximum output current.
- Values based on design and/or characterization.

# NCV8760C

## CHARACTERISTICS CURVES – 5.0 V Option

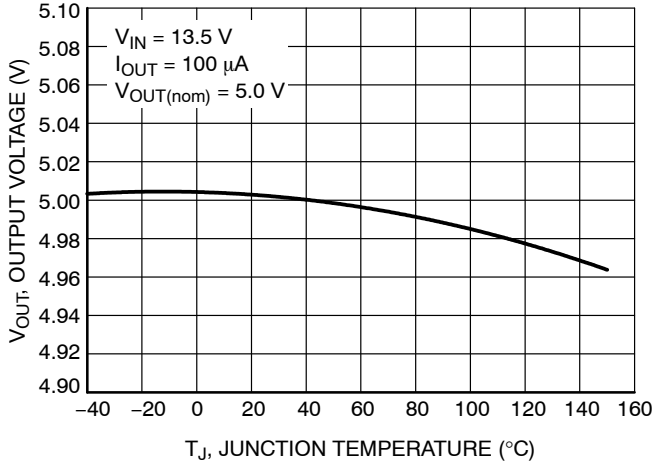

**Figure 4. Output Voltage vs. Junction Temperature**

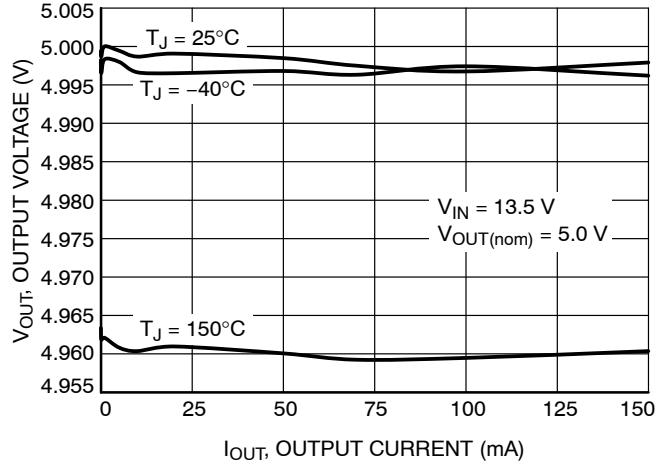

**Figure 5. Output Voltage vs. Output Current**

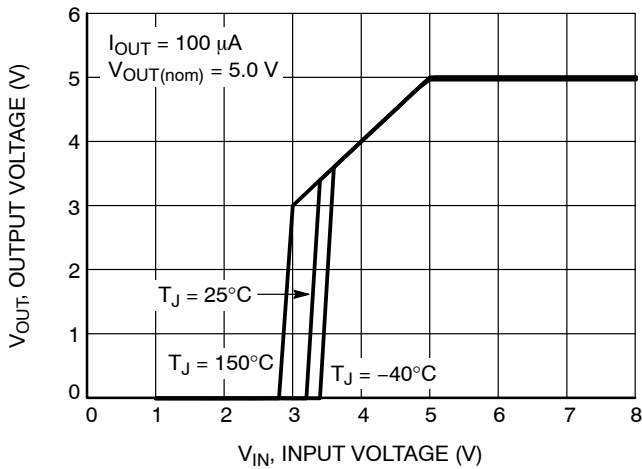

**Figure 6. Output Voltage vs. Input Voltage**

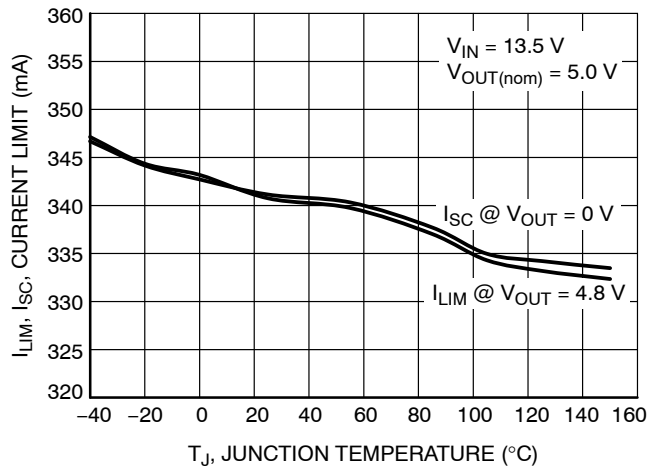

**Figure 7. Output Current Limit vs. Junction Temperature**

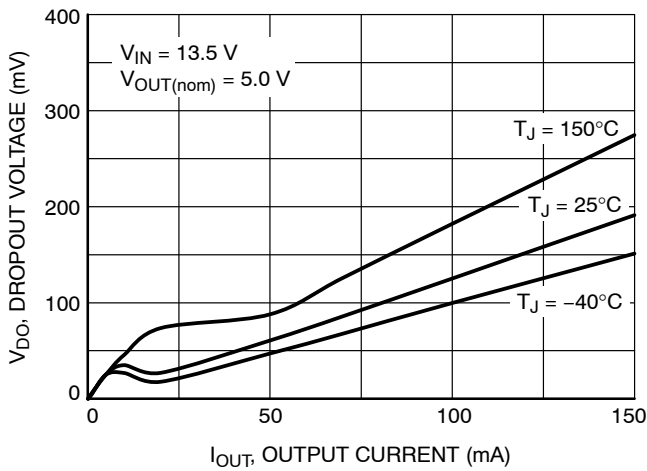

**Figure 8. Dropout Voltage vs. Output Current**

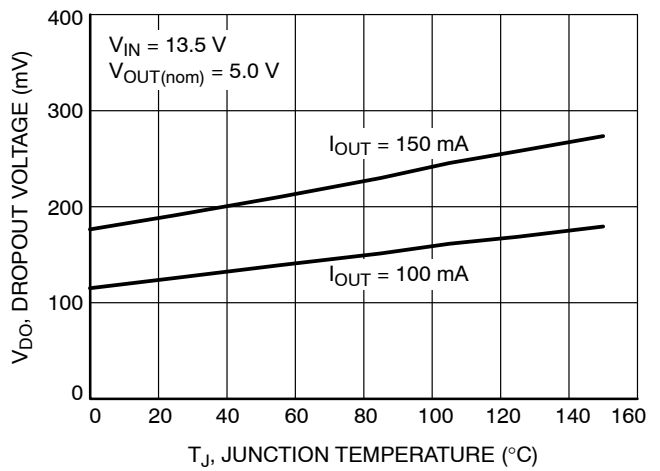

**Figure 9. Dropout Voltage vs. Junction Temperature**

# NCV8760C

## CHARACTERISTICS CURVES – 5.0 V Option

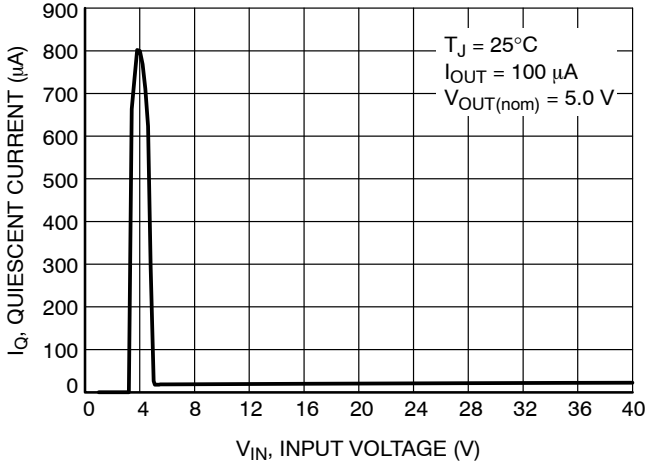

Figure 10. Quiescent Current vs. Input Voltage

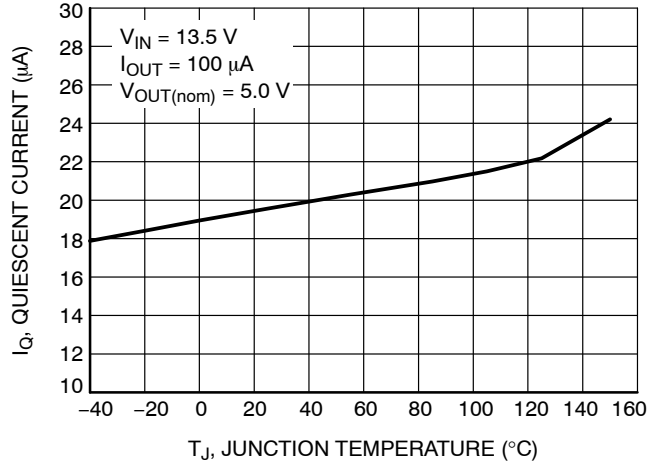

Figure 11. Quiescent Current vs. Junction Temperature

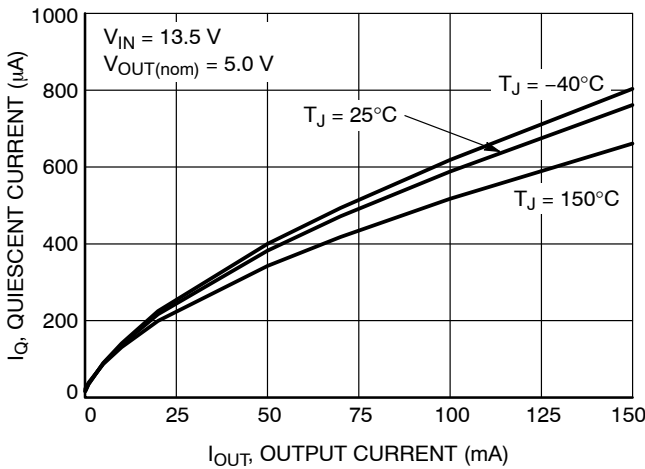

Figure 12. Quiescent Current vs. Output Current

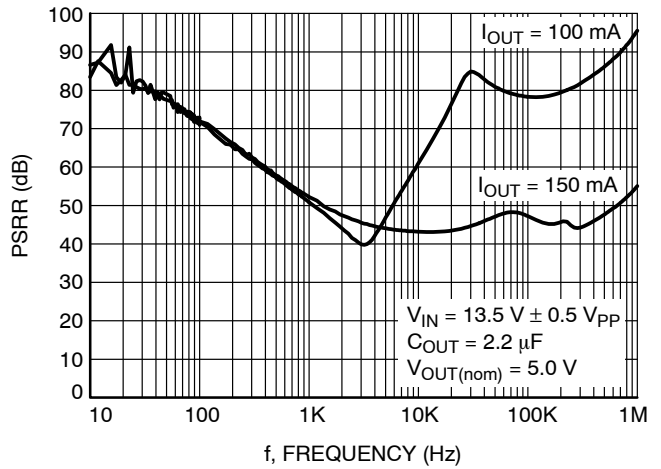

Figure 13. PSRR vs. Frequency

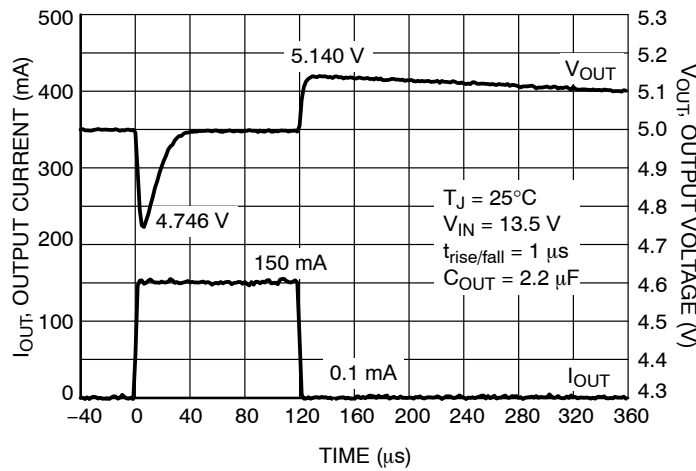

Figure 14. Load Transients

# NCV8760C

## CHARACTERISTICS CURVES – 5.0 V Option

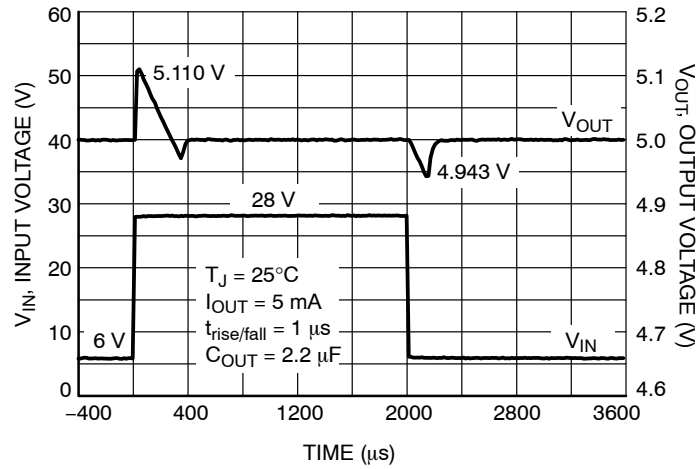

Figure 15. Line Transients

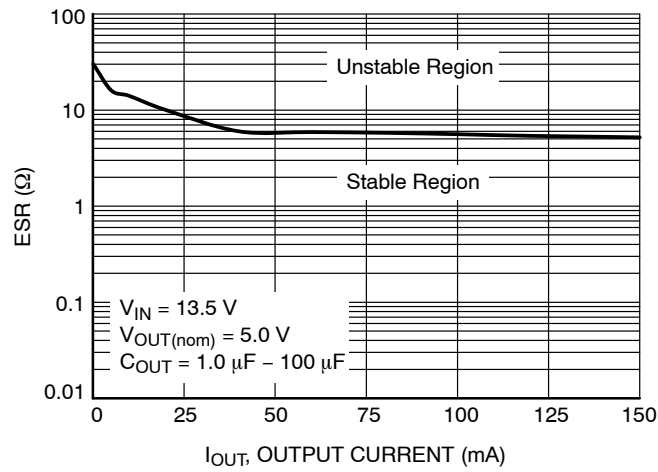
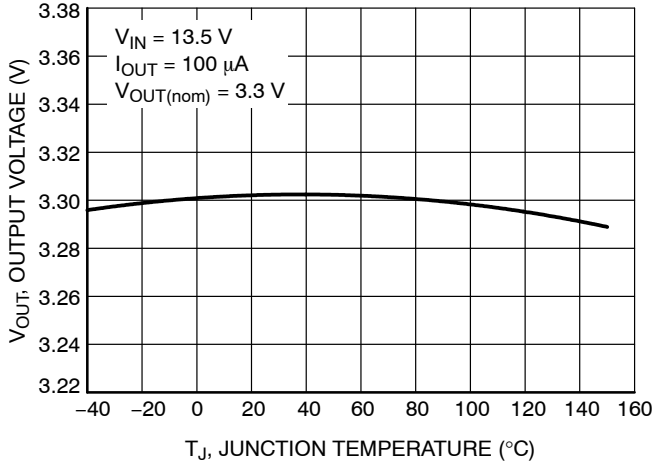

Figure 16. Output Stability with Output Capacitor ESR



# NCV8760C

## CHARACTERISTICS CURVES – 3.3 V Option



**Figure 17. Output Voltage vs. Junction Temperature**

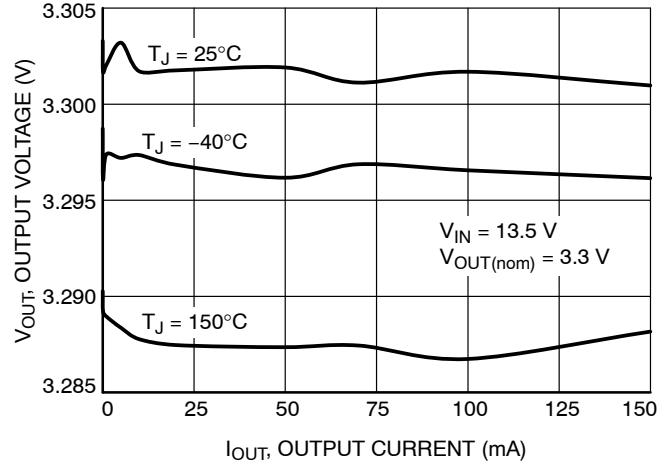

**Figure 18. Output Voltage vs. Output Current**

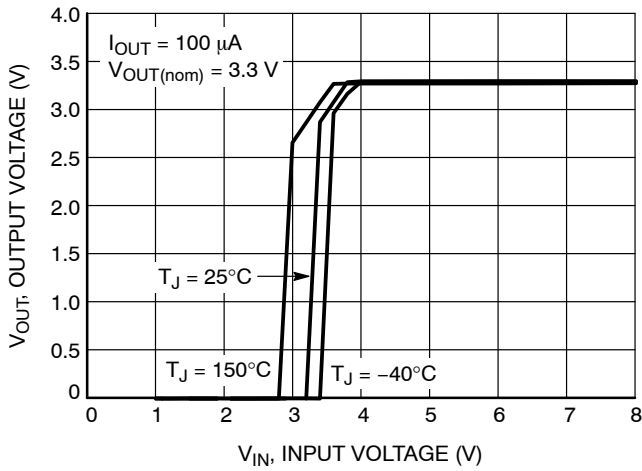

**Figure 19. Output Voltage vs. Input Voltage**

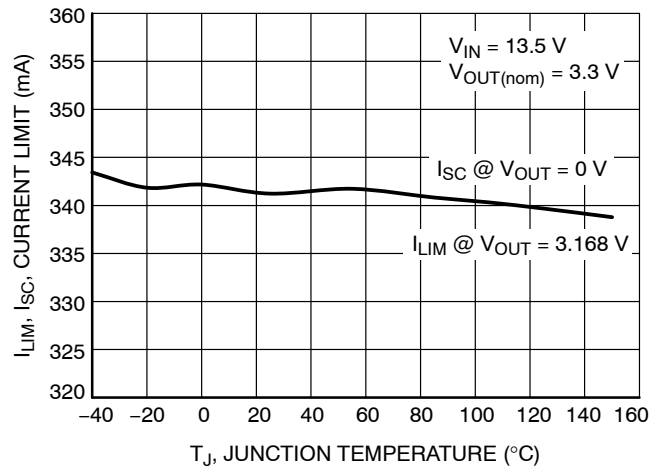

**Figure 20. Output Current Limit vs. Junction Temperature**

CHARACTERISTICS CURVES – 3.3 V Option

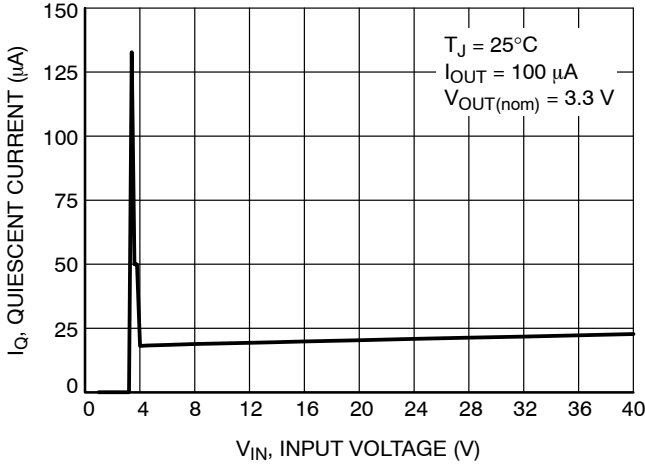

Figure 21. Quiescent Current vs. Input Voltage

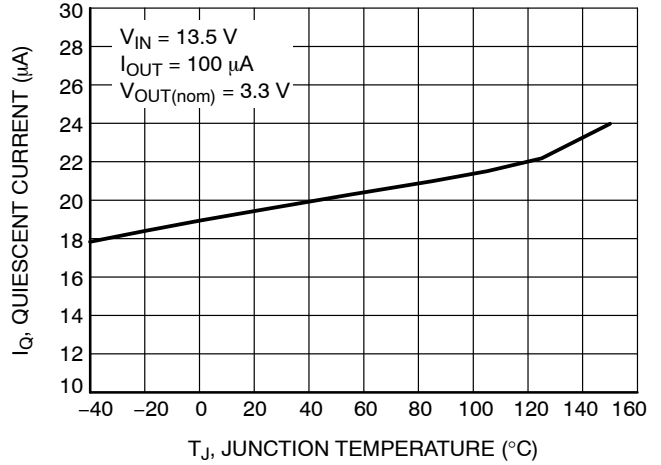

Figure 22. Quiescent Current vs. Junction Temperature

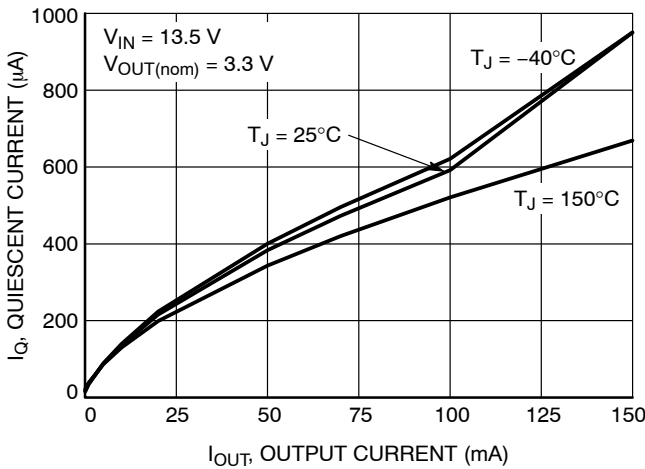

Figure 23. Quiescent Current vs. Output Current

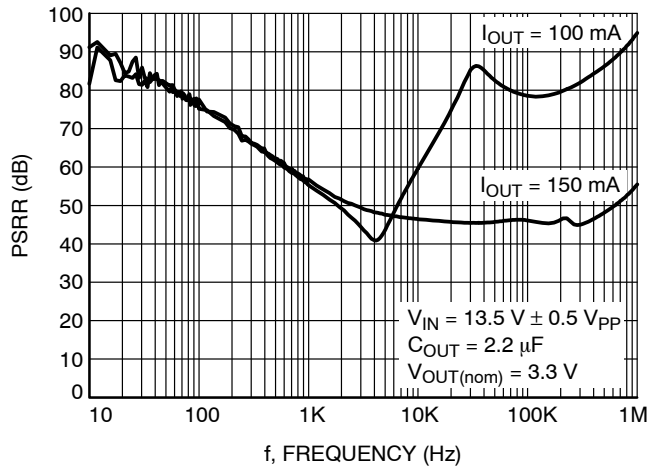

Figure 24. PSRR vs. Frequency

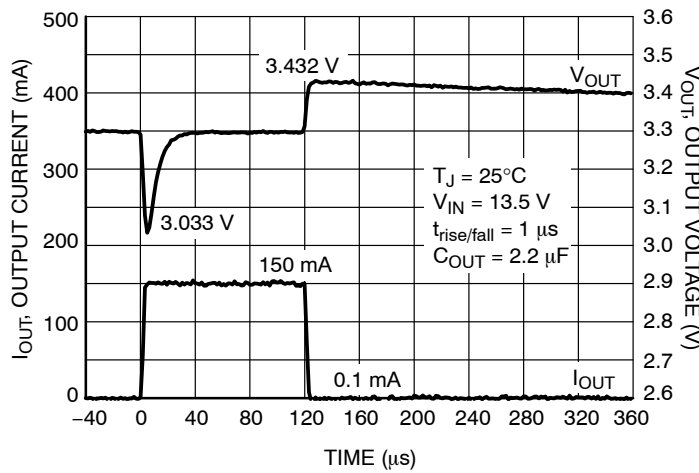

Figure 25. Load Transients

# NCV8760C

## CHARACTERISTICS CURVES – 3.3 V Option

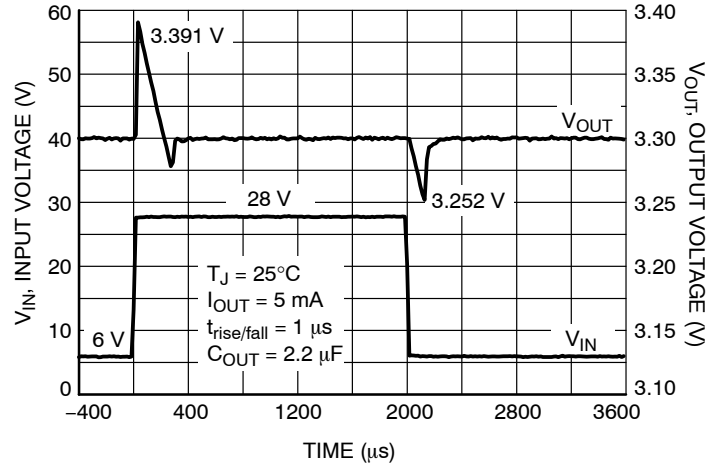

Figure 26. Line Transients

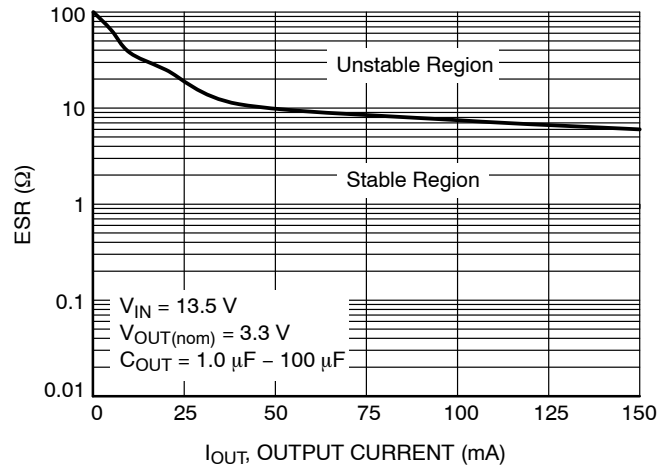

Figure 27. Output Stability with Output Capacitor ESR

DETAILED OPERATING DESCRIPTION

**General**

The NCV8760C is a 5 V and 3.3 V linear regulator providing low drop-out voltage for 150 mA at low quiescent current levels. Also featured in this part is a reset output with selectable delay times. Delay times are selectable via part selection and control through the Delay Time Select (DT) pin. A ceramic or tantalum 0.1  $\mu$ F capacitor is recommended and should be connected to  $V_{IN}$  to GND close to the NCV8760C package. If extremely fast input voltage transients are expected with slew rate in excess of 4 V/ $\mu$ s then appropriate input filter must be used. Thermal shutdown functionality protects the IC from damage caused from excessively high temperatures appearing on the IC.

**Output Voltage**

Output voltage stability is determined by the output capacitor selection. The NCV8760C has been designed to work with low ESR (equivalent series resistance) ceramic capacitors. The NCV8760C is stable using any capacitor 1  $\mu$ F and above with ESR below 5  $\Omega$ . Stable region of ESR in Figure 16 shows ESR values at which the LDO output voltage does not have any permanent oscillations at any dynamic changes of output load current. Marginal ESR is the value at which the output voltage waving is fully damped during four periods after the load change and no oscillation is further observable. ESR characteristics were measured with ceramic capacitors and additional series resistors to

emulate ESR. Low duty cycle pulse load current technique has been used to maintain junction temperature close to ambient temperature.

Larger values improve noise rejection and load regulation transient response.

**Current Limit**

Current limit is provided on  $V_{OUT}$  to protect the IC. The minimum specification is 205 mA. Current limit is specified under two conditions ( $V_{OUT} = 96\% \times V_{OUT\_NOM}$ ) and ( $V_{OUT} = 0$  V). No fold-back circuitry exists. Any measured differences can be attributed to change in die temperature. The part may be operated up to 205 mA provided thermal die temperature is considered and is kept below 150°C. A reset (RO) will not occur with a load less than 205 mA.

**Reset Output**

A reset signal is provided on the Reset Output (RO) pin to provide feedback to the microprocessor of an out of regulation condition. This is in the form of a logic signal on RO. Output ( $V_{OUT}$ ) voltage conditions below the RESET threshold cause RO to go low. The RO integrity is maintained down to  $V_{OUT} = 1.0$  V.

The NCV8670C contains an internal 30 k $\Omega$  pull up resistor. In case of RO function the external pull up resistor is optional to use (Figure 1).

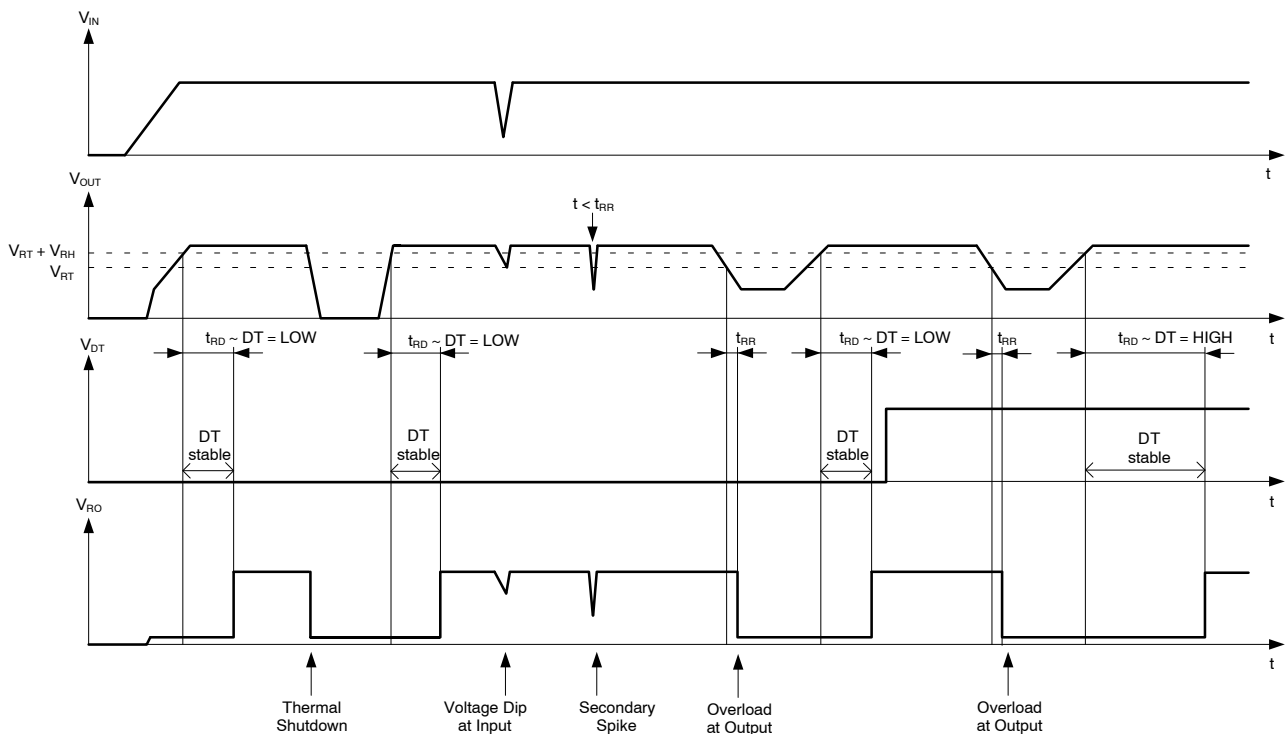

Figure 28. Reset Timing

## NCV8760C

During power-up (or restoring  $V_{OUT}$  voltage from a reset event), the  $V_{OUT}$  voltage must be maintained above the Reset threshold for the Reset Delay time before RO goes high. The time for Reset Delay is determined by the choice of IC and the state of the DT pin.

### Reset Delay Time Select

Selection of the NCV8760C device and the state of the DT pin determines the available Reset Delay times. The part is designed for use with DT tied to ground or  $V_{OUT}$ ; but may be controlled by any logic signal which provides a threshold between 0.8 V and 2 V. The default condition for an open DT pin is the faster Reset time (DT = GND condition). Times are in pairs and are highlighted in the table below. Consult factory for availability.

Marking – 760yCxG	DT=GND	DT=OUT
y = Reset Time	Reset Time	Reset Time
1	8 ms	128 ms
2	8 ms	32 ms
3	16 ms	64 ms
4	32 ms	128 ms

NOTE: The timing values can be selected from the following list: 8, 16, 32, 64, 128 ms. Contact factory for options not included in ORDERING INFORMATION table on page 13.

Note the DT pin is sampled within 24  $\mu$ s period after  $V_{OUT}$  rises above  $V_{RT} + V_{RH}$  voltage. It is not recommended to change DT logic level during “DT stable” time window. Example of reset delay time selection is shown in Figure 28.

### Thermal Shutdown

When the die temperature exceeds the Thermal Shutdown threshold, a Thermal Shutdown event is detected,  $V_{OUT}$  is turned off and RO goes low. The IC will remain in this state until the die temperature decreases below the shutdown threshold (175°C typical) minus the hysteresis factor (10°C typical). Then the output turns on and RO goes high after the RESET Delay time.

### Hints

$V_{IN}$  and GND printed circuit board traces should be as wide as possible. When the impedance of these traces is high, there is a chance to pick up noise or cause the regulator to malfunction. Place external components, especially the output capacitor, as close as possible to the device to improve EMC performance.

The NCV8760C is not developed in compliance with ISO26262 standard. If application is safety critical then the below application example diagram shown in Figure 29 can be used.

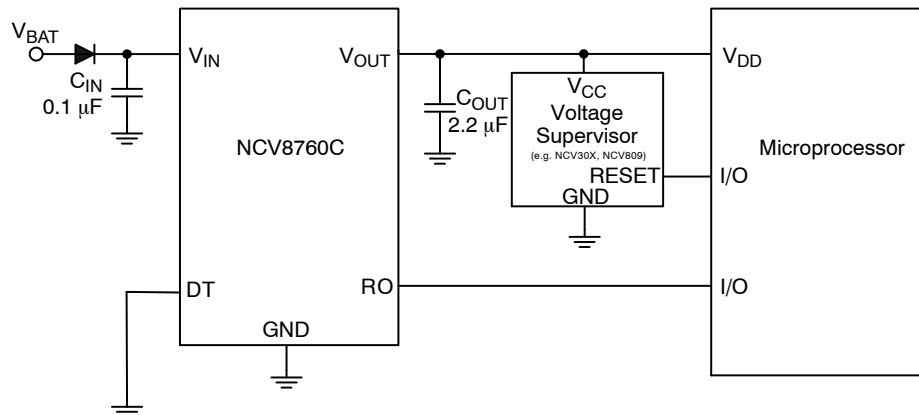

Figure 29. NCV8760C Application Diagram

# NCV8760C

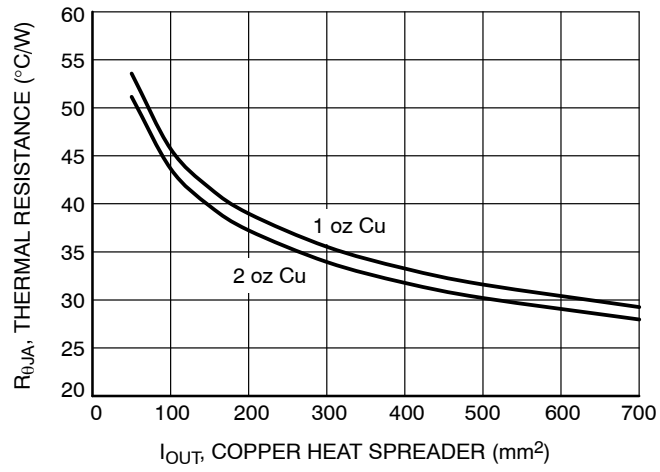

Figure 30.  $R_{\theta JA}$  vs. PCB Copper Area (DPAK)

## ORDERING INFORMATION

Device	Output Voltage	Reset Delay Time, DT to GND	Reset Delay Time, DT to OUT	Package	Shipping <sup>†</sup>
NCV8760CDT501RKG	5.0 V	8 ms	128 ms	DPAK (Pb-Free)	2500 / Tape & Reel
NCV8760CDT332RKG	3.3 V	8 ms	32 ms	DPAK (Pb-Free)	2500 / Tape & Reel
NCV8760CDT333RKG		16 ms	64 ms		

<sup>†</sup>For information on tape and reel specifications, including part orientation and tape sizes, please refer to our Tape and Reel Packaging Specification Brochure, BRD8011/D.

# NCV8760C

## PACKAGE DIMENSIONS

### DPAK 5, CENTER LEAD CROP DT SUFFIX CASE 175AA ISSUE B

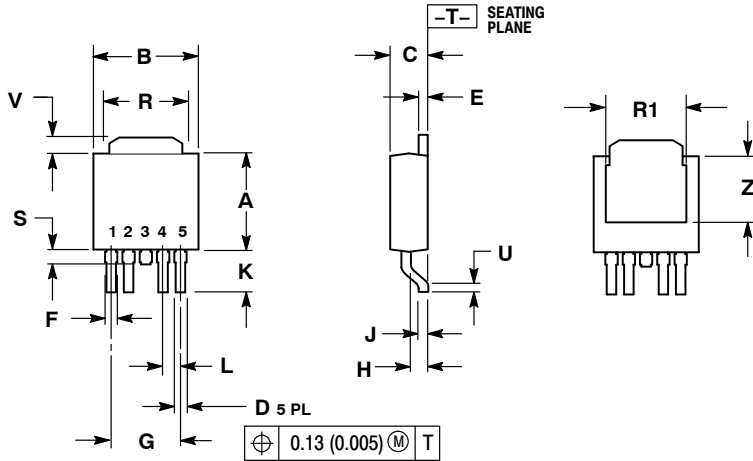

- NOTES:  
1. DIMENSIONING AND TOLERANCING PER ANSI Y14.5M, 1982.  
2. CONTROLLING DIMENSION: INCH.

DIM	INCHES		MILLIMETERS	
	MIN	MAX	MIN	MAX
A	0.235	0.245	5.97	6.22
B	0.250	0.265	6.35	6.73
C	0.086	0.094	2.19	2.38
D	0.020	0.028	0.51	0.71
E	0.018	0.023	0.46	0.58
F	0.024	0.032	0.61	0.81
G	0.180 BSC		4.56 BSC	
H	0.034	0.040	0.87	1.01
J	0.018	0.023	0.46	0.58
K	0.102	0.114	2.60	2.89
L	0.045 BSC		1.14 BSC	
R	0.170	0.190	4.32	4.83
R1	0.185	0.210	4.70	5.33
S	0.025	0.040	0.63	1.01
U	0.020	---	0.51	---
V	0.035	0.050	0.89	1.27
Z	0.155	0.170	3.93	4.32

### SOLDERING FOOTPRINT\*

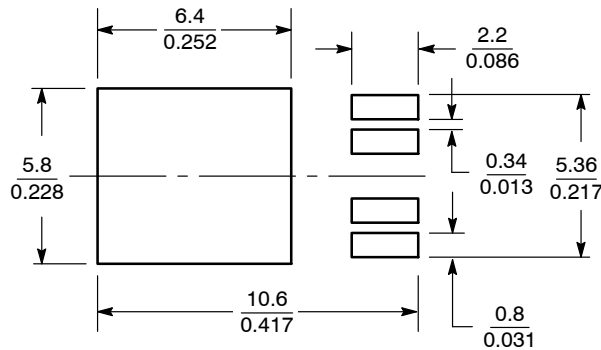

SCALE 4:1  $\left(\frac{\text{mm}}{\text{inches}}\right)$

\*For additional information on our Pb-Free strategy and soldering details, please download the ON Semiconductor Soldering and Mounting Techniques Reference Manual, SOLDERRM/D.

ON Semiconductor and are trademarks of Semiconductor Components Industries, LLC dba ON Semiconductor or its subsidiaries in the United States and/or other countries. ON Semiconductor owns the rights to a number of patents, trademarks, copyrights, trade secrets, and other intellectual property. A listing of ON Semiconductor's product/patent coverage may be accessed at [www.onsemi.com/site/pdf/Patent-Marking.pdf](http://www.onsemi.com/site/pdf/Patent-Marking.pdf). ON Semiconductor reserves the right to make changes without further notice to any products herein. ON Semiconductor makes no warranty, representation or guarantee regarding the suitability of its products for any particular purpose, nor does ON Semiconductor assume any liability arising out of the application or use of any product or circuit, and specifically disclaims any and all liability, including without limitation special, consequential or incidental damages. Buyer is responsible for its products and applications using ON Semiconductor products, including compliance with all laws, regulations and safety requirements or standards, regardless of any support or applications information provided by ON Semiconductor. "Typical" parameters which may be provided in ON Semiconductor data sheets and/or specifications can and do vary in different applications and actual performance may vary over time. All operating parameters, including "Typicals" must be validated for each customer application by customer's technical experts. ON Semiconductor does not convey any license under its patent rights nor the rights of others. ON Semiconductor products are not designed, intended, or authorized for use as a critical component in life support systems or any FDA Class 3 medical devices or medical devices with a same or similar classification in a foreign jurisdiction or any devices intended for implantation in the human body. Should Buyer purchase or use ON Semiconductor products for any such unintended or unauthorized application, Buyer shall indemnify and hold ON Semiconductor and its officers, employees, subsidiaries, affiliates, and distributors harmless against all claims, costs, damages, and expenses, and reasonable attorney fees arising out of, directly or indirectly, any claim of personal injury or death associated with such unintended or unauthorized use, even if such claim alleges that ON Semiconductor was negligent regarding the design or manufacture of the part. ON Semiconductor is an Equal Opportunity/Affirmative Action Employer. This literature is subject to all applicable copyright laws and is not for resale in any manner.

### PUBLICATION ORDERING INFORMATION

LITERATURE FULFILLMENT:  
Email Requests to: [orderlit@onsemi.com](mailto:orderlit@onsemi.com)

TECHNICAL SUPPORT  
North American Technical Support:  
Voice Mail: 1 800-282-9855 Toll Free USA/Canada  
Phone: 011 421 33 790 2910

Europe, Middle East and Africa Technical Support:  
Phone: 00421 33 790 2910  
For additional information, please contact your local Sales Representative

## X-ON Electronics

Largest Supplier of Electrical and Electronic Components

*Click to view similar products for [LDO Voltage Regulators](#) category:*

*Click to view products by [ON Semiconductor](#) manufacturer:*

Other Similar products are found below :

[AP7363-SP-13](#) [NCV8664CST33T3G](#) [L79M05TL-E](#) [AP7362-HA-7](#) [PT7M8202B12TA5EX](#) [TCR3DF185,LM\(CT](#) [TLF4949EJ](#)  
[NCP4687DH15T1G](#) [NCV8703MX30TCG](#) [LP2951CN](#) [NCV4269CPD50R2G](#) [AP7315-25W5-7](#) [NCV47411PAAJR2G](#) [AP2111H-1.2TRG1](#)  
[ZLDO1117QK50TC](#) [AZ1117ID-ADJTRG1](#) [NCV4263-2CPD50R2G](#) [NCP114BMX075TCG](#) [MC33269T-3.5G](#) [TLE4471GXT](#) [AP7315-33SA-](#)  
[7](#) [NCV4266-2CST33T3G](#) [NCP715SQ15T2G](#) [NCV8623MN-50R2G](#) [NCV563SQ18T1G](#) [NCV8664CDT33RKG](#) [NCV4299CD250R2G](#)  
[NCV8702MX25TCG](#) [TLE7270-2E](#) [NCV562SQ25T1G](#) [AP2213D-3.3TRG1](#) [AP2202K-2.6TRE1](#) [NCV8170BMX300TCG](#)  
[NCV8152MX300180TCG](#) [NCP700CMT45TBG](#) [AP7315-33W5-7](#) [NCP154MX180300TAG](#) [AP2113AMTR-G1](#) [NJW4104U2-33A-TE1](#)  
[MP2013AGG-5-P](#) [NCV8775CDT50RKG](#) [NJM2878F3-45-TE1](#) [S-19214B00A-V5T2U7](#) [S-19214B50A-V5T2U7](#) [S-19213B50A-V5T2U7](#) [S-](#)  
[19214BC0A-E8T1U7\\*1](#) [S-19213B00A-V5T2U7](#) [S-19213B33A-V5T2U7](#) [S-19213BC0A-V5T2U7](#) [S-1313D18-N4T1U4](#)