

NLSF1174

Hex D Flip-Flop with Common Clock and Reset

This device consists of six D flip-flops with common Clock and Reset inputs. Each flip-flop is loaded with a low-to-high transition of the Clock input. Reset is asynchronous and active low. All inputs/outputs are standard CMOS compatible.

Features

- Output Drive Compatibility: 10 LSTTL Loads
- Outputs Directly Interface to CMOS
- Operating Voltage Range: 2.0 to 6.0 V
- Low Input Current: 1.0 μ A
- MSL Level 1
- Chip Complexity: 162 FET
- Pb-Free Package is Available*

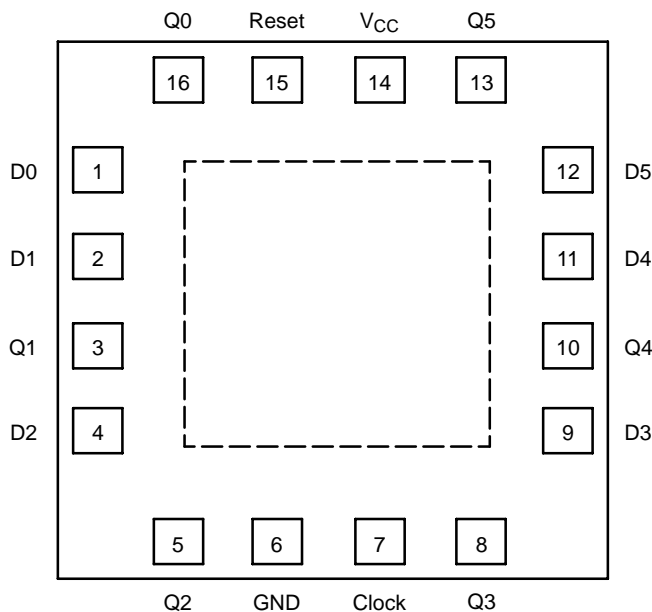

Center pad on bottom may be connected to V_{CC} of device.
This pad must be isolated or connected to V_{CC} .

Figure 1. PIN ASSIGNMENT (Top View)



ON Semiconductor®

<http://onsemi.com>



QFN-16
MN SUFFIX
CASE 485G

MARKING DIAGRAM

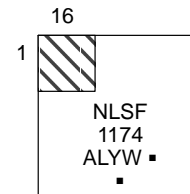

NLSF1174 = Device Code
 A = Assembly Location
 L = Wafer Lot
 Y = Year
 W = Work Week
 ■ = Pb-Free Package
 (Note: Microdot may be in either location)

FUNCTION TABLE

Inputs			Output
Reset	Clock	D	Q
L	X	X	L
H		H	H
H		L	L
H	L	X	No Change
H		X	No Change

ORDERING INFORMATION

Device	Package	Shipping†
NLSF1174MNR2	QFN-16	3000 / Tape & Reel
NLSF1174MNR2G	QFN-16 (Pb-Free)	3000 / Tape & Reel

†For information on tape and reel specifications, including part orientation and tape sizes, please refer to our Tape and Reel Packaging Specifications Brochure, BRD8011/D.

*For additional information on our Pb-Free strategy and soldering details, please download the ON Semiconductor Soldering and Mounting Techniques Reference Manual, SOLDERRM/D.

NLSF1174

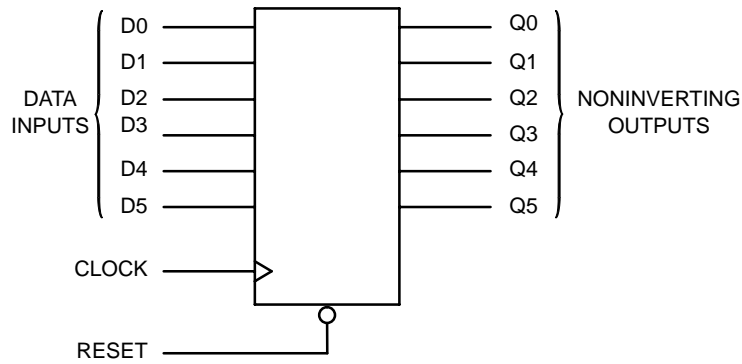

Figure 2. LOGIC DIAGRAM

DESIGN/VALUE TABLE

Design Criteria	Value	Unit
Internal Gate Count*	40.5	ea
Internal Gate Propagation Delay	1.5	ns
Internal Gate Power Dissipation	5.0	μ W
Speed Power Product	.0075	pJ

*Equivalent to a two-input NAND gate.

MAXIMUM RATINGS

Parameter	Symbol	Value	Unit
DC Supply Voltage (Referenced to GND)	V_{CC}	-0.5 to +7.0	V
DC Input Voltage (Referenced to GND)	V_{IN}	-1.5 to $V_{CC} + 1.5$	V
DC Output Voltage (Referenced to GND) (Note 1)	V_{OUT}	-0.5 to $V_{CC} + 0.5$	V
DC Input Current, per Pin	I_{IN}	± 20	mA
DC Output Current, per Pin	I_{OUT}	± 25	mA
DC Supply Current, V_{CC} and GND Pins	I_{CC}	± 50	mA
Storage Temperature Range	T_{STG}	-65 to +150	$^{\circ}$ C
Lead Temperature, 1 mm from Case for 10 Seconds PDIP, SOIC, TSSOP	T_L	260	$^{\circ}$ C
Junction Temperature Under Bias	T_J	+150	$^{\circ}$ C
Thermal Resistance QFN	θ_{JA}	80	$^{\circ}$ C/W
Power Dissipation in Still Air at 85 $^{\circ}$ C QFN	P_D	800	mW
Moisture Sensitivity	MSL	Level 1	
Flammability Rating Oxygen Index: 30 to 35	F_R	UL 94 V-0 @ 0.125 in	
ESD Withstand Voltage Human Body Model (Note 2) Machine Model (Note 3) Charged Device Model (Note 4)	V_{ESD}	> 2000 > 100 > 500	V
Latchup Performance Above V_{CC} and Below GND at 85 $^{\circ}$ C (Note 5)	$I_{LATCHUP}$	± 300	mA

Stresses exceeding Maximum Ratings may damage the device. Maximum Ratings are stress ratings only. Functional operation above the Recommended Operating Conditions is not implied. Extended exposure to stresses above the Recommended Operating Conditions may affect device reliability.

1. I_O absolute maximum rating must be observed.

2. Tested to EIA/JESD22-A114-A.

3. Tested to EIA/JESD22-A115-A.

4. Tested to JESD22-C101-A.

5. Tested to EIA/JESD78.

6. For high frequency or heavy load considerations, see the ON Semiconductor High-Speed CMOS Data Book (DL129/D).

RECOMMENDED OPERATING CONDITIONS

Parameter	Symbol	Min	Max	Unit
DC Supply Voltage (Referenced to GND)	V_{CC}	2.0	6.0	V
DC Input Voltage, Output Voltage (Referenced to GND) (Note 7)	V_{IN}, V_{OUT}	0	V_{CC}	V
Operating Temperature, All Package Types	T_A	-55	+125	°C
Input Rise and Fall Time (Figure 4)	t_r, t_f	0	1000	ns
	$V_{CC} = 2.0\text{ V}$	0	500	
	$V_{CC} = 4.5\text{ V}$	0	400	
	$V_{CC} = 6.0\text{ V}$	0	400	

7. Unused inputs may not be left open. All inputs must be tied to a high- or low-logic input voltage level.

DC ELECTRICAL CHARACTERISTICS (Voltages Referenced to GND)

Parameter	Test Conditions	Symbol	V_{CC} V	Guaranteed Limit			Unit
				-55°C to 25°C	≤85°C	≤125°C	
Minimum High-Level Input Voltage	$V_{OUT} = 0.1\text{ V}$ or $V_{CC} - 0.1\text{ V}$ $ I_{OUT} \leq 20\ \mu\text{A}$	V_{IH}	2.0	1.5	1.5	1.5	V
			4.5	3.15	3.15	3.15	
			6.0	4.2	4.2	4.2	
Maximum Low-Level Input Voltage	$V_{OUT} = 0.1\text{ V}$ or $V_{CC} - 0.1\text{ V}$ $ I_{OUT} \leq 20\ \mu\text{A}$	V_{IL}	2.0	0.5	0.5	0.5	V
			4.5	1.35	1.35	1.35	
			6.0	1.8	1.8	1.8	
Minimum High-Level Output Voltage	$V_{IN} = V_{IH}$ or V_{IL} $ I_{OUT} \leq 20\ \mu\text{A}$	V_{OH}	2.0	1.9	1.9	1.9	V
			4.5	4.4	4.4	4.4	
			6.0	5.9	5.9	5.9	
	$V_{IN} = V_{IH}$ or V_{IL} $ I_{OUT} \leq 4.0\text{ mA}$ $ I_{OUT} \leq 5.2\text{ mA}$		4.5	3.98	3.84	3.7	
			6.0	5.48	5.34	5.2	
Maximum Low-Level Output Voltage	$V_{IN} = V_{IH}$ or V_{IL} $ I_{OUT} \leq 20\ \mu\text{A}$	V_{OL}	2.0	0.1	0.1	0.1	V
			4.5	0.1	0.1	0.1	
			6.0	0.1	0.1	0.1	
			4.5	0.26	0.33	0.4	
			6.0	0.26	0.33	0.4	
Maximum Input Leakage Current	$V_{IN} = V_{CC}$ or GND	I_{IN}	6.0	±0.1	±1.0	±1.0	µA
Maximum Quiescent Supply Current (per Package)	$V_{IN} = V_{CC}$ or GND $I_{OUT} = 0\ \mu\text{A}$	I_{CC}	6.0	4.0	40	160	µA

8. Information on typical parametric values, along with high frequency or heavy load considerations, can be found in the ON Semiconductor High-Speed CMOS Data Book (DL129/D).

AC ELECTRICAL CHARACTERISTICS ($C_L = 50\text{ pF}$, Input $t_r = t_f = 6.0\text{ ns}$)

Parameter	Symbol	V_{CC} V	Guaranteed Limit			Unit
			-55°C to 25°C	≤85°C	≤125°C	
Maximum Clock Frequency (50% Duty Cycle) (Figures 4 and 7)	f_{max}	2.0	6.0	4.8	4.0	MHz
		4.5	30	24	20	
		6.0	35	28	24	
Maximum Propagation Delay, Clock to Q (Figures 5 and 7)	t_{PLH} t_{PHL}	2.0	110	140	165	ns
		4.5	22	28	33	
		6.0	19	24	28	
Maximum Propagation Delay, Reset to Q (Figures 2 and 7)	t_{PLH} t_{PHL}	2.0	110	140	160	ns
		4.5	21	28	32	
		6.0	19	24	27	
Maximum Output Transition Time, Any Output (Figures 4 and 7)	t_{TLH} t_{THL}	2.0	75	95	110	ns
		4.5	15	19	22	
		6.0	13	16	19	
Maximum Input Capacitance	C_{in}		10	10	10	pF
Power Dissipation Capacitance, per Enabled Output (Note 10)	C_{PD}	Typical @ 25°C, $V_{CC} = 5.0\text{ V}$				pF
		62				

9. For propagation delays with loads other than 50 pF, and information on typical parametric values, see the ON Semiconductor High-Speed CMOS Data Book (DL129/D).

10. Used to determine the no-load dynamic power consumption: $P_D = C_{PD} V_{CC}^2 f + I_{CC} V_{CC}$. For load considerations, see the ON Semiconductor High-Speed CMOS Data Book (DL129/D).

NLSF1174

TIMING REQUIREMENTS ($C_L = 50 \text{ pF}$, Input $t_r = t_f = 6.0 \text{ ns}$)

Parameter	Figure	Symbol	V_{CC} V	Guaranteed Limit						Unit
				-55°C to 25°C		≤ 85°C		≤ 125°C		
				Min	Max	Min	Max	Min	Max	
Minimum Setup Time, Data to Clock	6	t_{su}	2.0 4.5 6.0	50 10 9.0		65 13 11		75 15 13		ns
Minimum Hold Time, Clock to Data	6	t_h	2.0 4.5 6.0	5.0 5.0 5.0		5.0 5.0 5.0		5.0 5.0 5.0		ns
Minimum Recovery Time, Reset Inactive to Clock	5	t_{rec}	2.0 4.5 6.0	5.0 5.0 5.0		5.0 5.0 5.0		5.0 5.0 5.0		ns
Minimum Pulse Width, Clock	4	t_w	2.0 4.5 6.0	75 15 13		95 19 16		110 22 19		ns
Minimum Pulse Width, Reset	5	t_w	2.0 4.5 6.0	75 15 13		95 19 16		110 22 19		ns
Maximum Input Rise and Fall Times	4	t_r, t_f	2.0 4.5 6.0		1000 500 400		1000 500 400		1000 500 400	ns

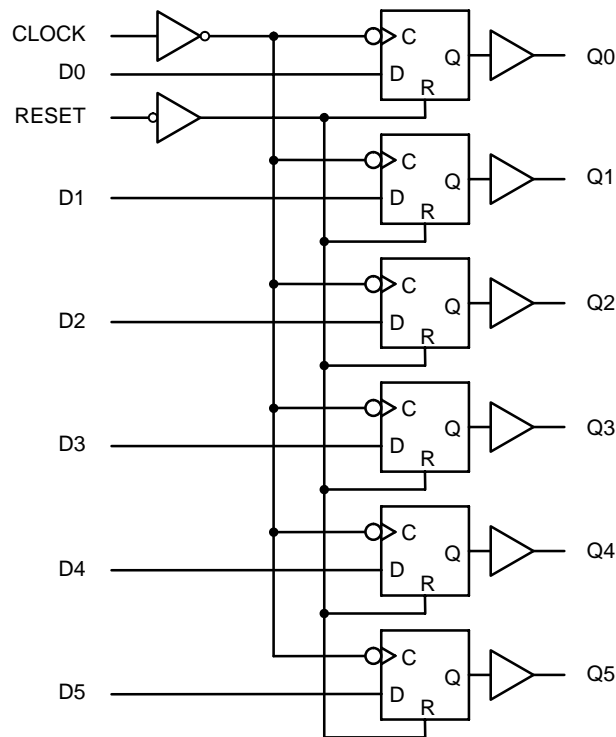

Figure 3. Expanded Logic Diagram

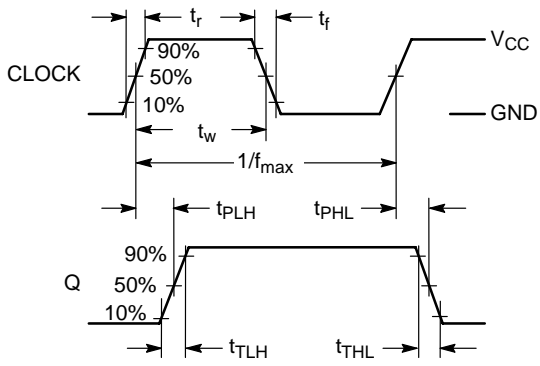

Figure 4. Switching Waveform

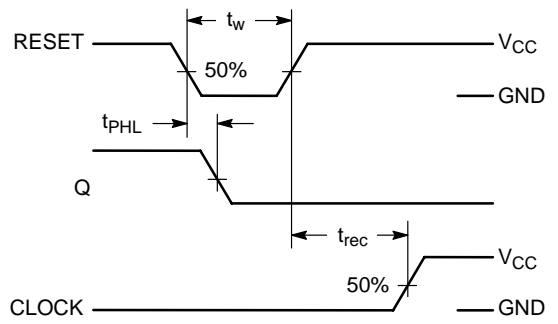

Figure 5. Switching Waveform

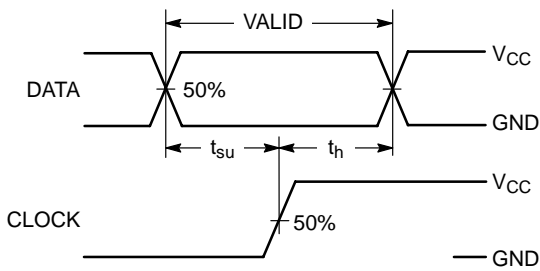
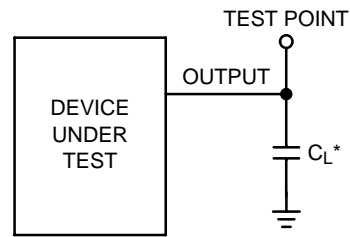

Figure 6. Switching Waveform



*Includes all probe and jig capacitance

Figure 7. Test Circuit

PIN1/PRODUCT ORIENTATION CARRIER TAPE

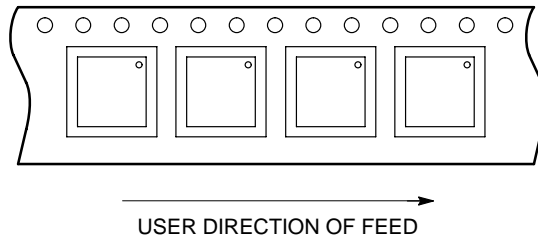

Figure 8.

MECHANICAL CASE OUTLINE PACKAGE DIMENSIONS



SCALE 2:1

QFN16 3x3, 0.5P
CASE 485G
ISSUE G

DATE 08 OCT 2021

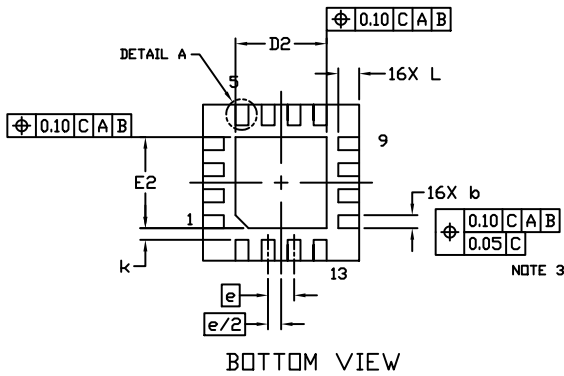
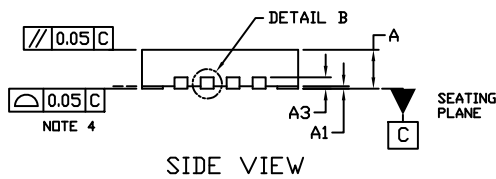
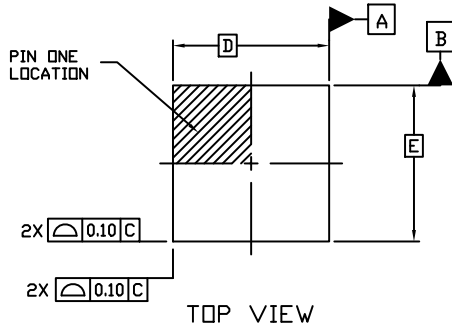

NOTES:

1. DIMENSIONING AND TOLERANCING PER ASME Y14.5M, 1994.
2. CONTROLLING DIMENSION: MILLIMETERS
3. DIMENSION *b* APPLIES TO PLATED TERMINAL AND IS MEASURED BETWEEN 0.15 AND 0.30 MM FROM THE TERMINAL TIP.
4. COPLANARITY APPLIES TO THE EXPOSED PAD AS WELL AS THE TERMINALS.

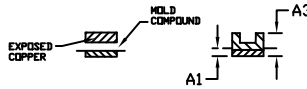

DETAIL B
ALTERNATE CONSTRUCTIONS

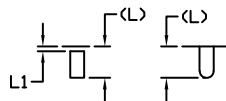

DETAIL A
ALTERNATE TERMINAL CONSTRUCTIONS

DIM	MILLIMETERS		
	MIN.	NDM.	MAX.
A	0.80	0.90	1.00
A1	0.00	0.03	0.05
A3	0.20 REF		
<i>b</i>	0.18	0.24	0.30
D	3.00 BSC		
D2	1.65	1.75	1.85
E	3.00 BSC		
E2	1.65	1.75	1.85
<i>e</i>	0.50 BSC		
<i>k</i>	0.18 TYP		
L	0.30	0.40	0.50
L1	0.00	0.08	0.15

MOUNTING FOOTPRINT

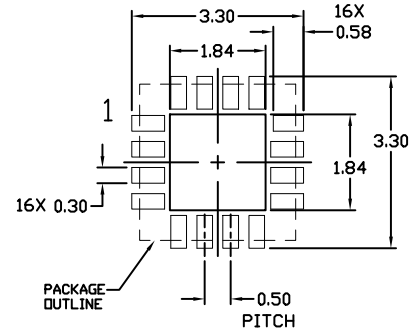

GENERIC MARKING DIAGRAM*

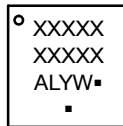

- XXXXX = Specific Device Code
- A = Assembly Location
- L = Wafer Lot
- Y = Year
- W = Work Week
- = Pb-Free Package

(Note: Microdot may be in either location)

*This information is generic. Please refer to device data sheet for actual part marking. Pb-Free indicator, "G" or microdot "▪", may or may not be present. Some products may not follow the Generic Marking.

DOCUMENT NUMBER:	98AON04795D	Electronic versions are uncontrolled except when accessed directly from the Document Repository. Printed versions are uncontrolled except when stamped "CONTROLLED COPY" in red.
DESCRIPTION:	QFN16 3X3, 0.5P	PAGE 1 OF 1

onsemi and ONSEMI are trademarks of Semiconductor Components Industries, LLC dba onsemi or its subsidiaries in the United States and/or other countries. onsemi reserves the right to make changes without further notice to any products herein. onsemi makes no warranty, representation or guarantee regarding the suitability of its products for any particular purpose, nor does onsemi assume any liability arising out of the application or use of any product or circuit, and specifically disclaims any and all liability, including without limitation special, consequential or incidental damages. onsemi does not convey any license under its patent rights nor the rights of others.

onsemi, **Onsemi**, and other names, marks, and brands are registered and/or common law trademarks of Semiconductor Components Industries, LLC dba "**onsemi**" or its affiliates and/or subsidiaries in the United States and/or other countries. **onsemi** owns the rights to a number of patents, trademarks, copyrights, trade secrets, and other intellectual property. A listing of **onsemi**'s product/patent coverage may be accessed at www.onsemi.com/site/pdf/Patent-Marking.pdf. **onsemi** reserves the right to make changes at any time to any products or information herein, without notice. The information herein is provided "as-is" and **onsemi** makes no warranty, representation or guarantee regarding the accuracy of the information, product features, availability, functionality, or suitability of its products for any particular purpose, nor does **onsemi** assume any liability arising out of the application or use of any product or circuit, and specifically disclaims any and all liability, including without limitation special, consequential or incidental damages. Buyer is responsible for its products and applications using **onsemi** products, including compliance with all laws, regulations and safety requirements or standards, regardless of any support or applications information provided by **onsemi**. "Typical" parameters which may be provided in **onsemi** data sheets and/or specifications can and do vary in different applications and actual performance may vary over time. All operating parameters, including "Typicals" must be validated for each customer application by customer's technical experts. **onsemi** does not convey any license under any of its intellectual property rights nor the rights of others. **onsemi** products are not designed, intended, or authorized for use as a critical component in life support systems or any FDA Class 3 medical devices or medical devices with a same or similar classification in a foreign jurisdiction or any devices intended for implantation in the human body. Should Buyer purchase or use **onsemi** products for any such unintended or unauthorized application, Buyer shall indemnify and hold **onsemi** and its officers, employees, subsidiaries, affiliates, and distributors harmless against all claims, costs, damages, and expenses, and reasonable attorney fees arising out of, directly or indirectly, any claim of personal injury or death associated with such unintended or unauthorized use, even if such claim alleges that **onsemi** was negligent regarding the design or manufacture of the part. **onsemi** is an Equal Opportunity/Affirmative Action Employer. This literature is subject to all applicable copyright laws and is not for resale in any manner.

PUBLICATION ORDERING INFORMATION

LITERATURE FULFILLMENT:

Email Requests to: orderlit@onsemi.com

onsemi Website: www.onsemi.com

TECHNICAL SUPPORT

North American Technical Support:

Voice Mail: 1 800-282-9855 Toll Free USA/Canada

Phone: 011 421 33 790 2910

Europe, Middle East and Africa Technical Support:

Phone: 00421 33 790 2910

For additional information, please contact your local Sales Representative

X-ON Electronics

Largest Supplier of Electrical and Electronic Components

Click to view similar products for [Flip-Flops](#) category:

Click to view products by [ON Semiconductor](#) manufacturer:

Other Similar products are found below :

[NLV14027BDG](#) [NLX1G74MUTCG](#) [703557B](#) [5962-90606022A](#) [5962-9060602FA](#) [NLV14013BDR2G](#) [M38510/30104BDA](#)
[M38510/07106BFA](#) [NTE4598B](#) [74LVC74APW-Q100J](#) [74LCX16374MTDX](#) [74LVT74D,118](#) [74VHCT9273FT\(BJ\)](#) [MM74HC374WM](#)
[74LVX74MTCX](#) [CD40174BF3A](#) [HMC723LC3CTR](#) [MM74HCT574MTCX](#) [5962-8681501RA](#) [MM74HCT273WM](#) [SN74LVC74APW](#)
[SN74LVC74AD](#) [SN74HC273DWR](#) [MC74HC11ADG](#) [M74HC175B1R](#) [M74HC174RM13TR](#) [74ALVTH16374ZQLR](#) [74ALVTH32374ZKER](#)
[74VHCV374FT\(BJ\)](#) [74VHCV574FT\(BJ\)](#) [SNJ54ALS574BJ](#) [SN74LVC74ADR](#) [SN74HC574PWR](#) [SN74HC374AN](#) [SN74AS574DWR](#)
[SN74ALS175NSR](#) [SN74HC175D](#) [SN74AC74D](#) [74AHC1G79GV.125](#) [74AHC74D.112](#) [74HC112D.652](#) [74HC574D.652](#) [74HCT173D.652](#)
[74HCT374D.652](#) [74AHC574D.118](#) [74AHCT1G79GW.125](#) [74HC273D.652](#) [74HC74D.653](#) [74HC107D.652](#) [74HC574D.653](#)