

NLV18HC1Gxx, NLV18HC1GTxx

Automotive High Speed Logic Gates

The NLV18HC1Gxx and NLV18HC1GTxx are automotive-grade High-Speed CMOS logic gates.

The NLV18HC1Gxx devices have CMOS input voltage levels while the NLV18HC1GTxx devices have TTL input voltage levels.

Features

- High Speed: $t_{PD} = 7$ ns (Typ) at $V_{CC} = 6$ V
- Low Power Dissipation: $I_{CC} = 1$ μ A (Max) at $T_A = 25^\circ\text{C}$
- High Noise Immunity
- Balanced Propagation Delays ($t_{PLH} = t_{PHL}$)
- Symmetrical Output Impedance ($I_{OH} = I_{OL} = 2$ mA)
- Operating Temperature: -55°C to $+125^\circ\text{C}$
AEC Grade 1-Compliant: -40°C to $+125^\circ\text{C}$
- Tiny SC-88A Package (other package offerings may be available upon request)
- AEC-Q100 Qualified and PPAP Capable
- These Devices are Pb-Free, Halogen Free/BFR Free and RoHS Compliant

FUNCTION LIST

xx	Function
00	2-Input NAND
02	2-Input NOR
04	Inverter
05	Open-Drain Inverter
07	Open-Drain Buffer
08	2-Input AND
14	Schmitt-Trigger Inverter
17	Schmitt-Trigger Buffer
32	2-Input OR
34	Buffer
86	2-Input XOR
125	Tri-State Buffer
126	Tri-State Buffer
U04	Unbuffered Inverter



ON Semiconductor®

www.onsemi.com



SC-88A
DF SUFFIX
CASE 419A

MARKING DIAGRAM

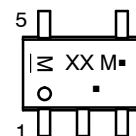

XX = Device Code
M = Date Code*
■ = Pb-Free Package

(Note: Microdot may be in either location)

*Date Code orientation and/or position may vary depending upon manufacturing location.

ORDERING INFORMATION

See detailed ordering and shipping information on page 10 of this data sheet.

NLV18HC1Gxx, NLV18HC1GTxx

Functions and Function Tables – Buffers and Inverters

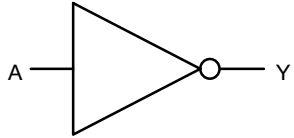

04 – Inverter
U04 – Unbuffered Inverter

A	Y
0	1
1	0

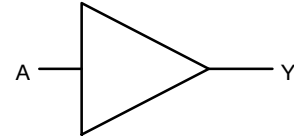

34 – Buffer

A	Y
0	0
1	1

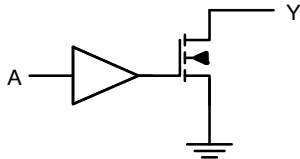

05 – Open-Drain Inverter

A	Y
0	Hi-Z
1	0

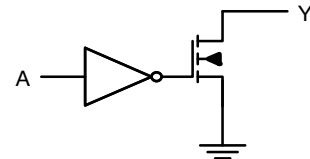

07 – Open-Drain Buffer

A	Y
0	0
1	Hi-Z

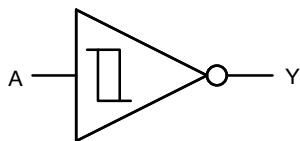

14 – Schmitt-Trigger Inverter

A	Y
0	1
1	0

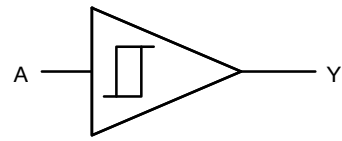

17 – Schmitt-Trigger Buffer

A	Y
0	0
1	1

Pin Assignment

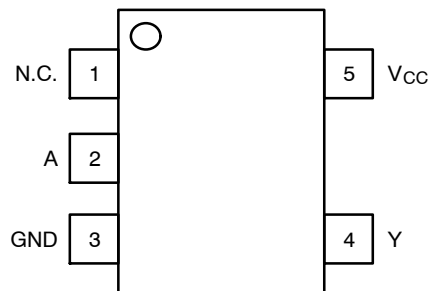

Pinout (Buffers and Inverters)

Pin	Name	Description
1	N.C.	No Connection
2	A	Input
3	GND	Ground
4	Y	Output
5	V _{CC}	Supply

NLV18HC1Gxx, NLV18HC1GTxx

Functions and Function Tables – Tri-State Buffers and Bus Drivers

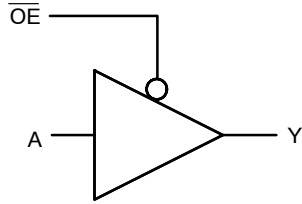

125 – Tri-State Buffer

OE	A	Y
0	0	0
0	1	1
1	X	Hi-Z

X = Don't Care

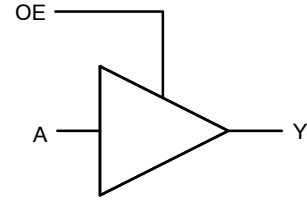

126 – Tri-State Buffer

OE	A	Y
0	X	Hi-Z
1	0	0
1	1	1

X = Don't Care

Pin Assignments

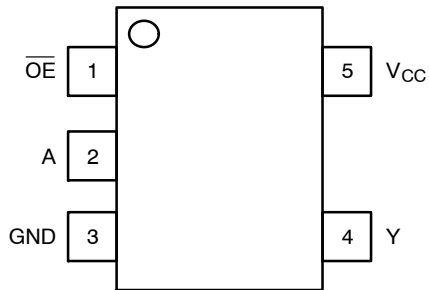

Pinout (125)

Pin	Name	Description
1	OE	Enable (Active-Low)
2	A	Input
3	GND	Ground
4	Y	Output
5	V _{CC}	Supply

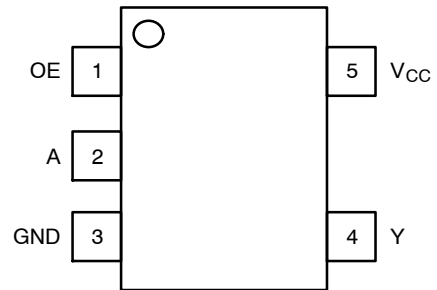

Pinout (126)

Pin	Name	Description
1	OE	Enable (Active-High)
2	A	Input
3	GND	Ground
4	Y	Output
5	V _{CC}	Supply

NLV18HC1Gxx, NLV18HC1GTxx

Functions and Function Tables – Gates

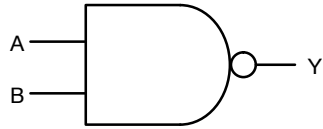

00 - NAND

A	B	Y
0	0	1
0	1	1
1	0	1
1	1	0

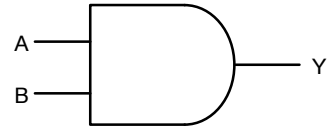

08 - AND

A	B	Y
0	0	0
0	1	0
1	0	0
1	1	1

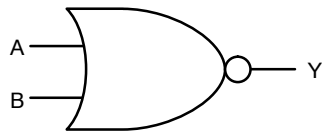

02 - NOR

A	B	Y
0	0	1
0	1	0
1	0	0
1	1	0

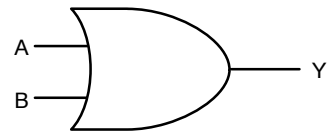

32 - OR

A	B	Y
0	0	0
0	1	1
1	0	1
1	1	1

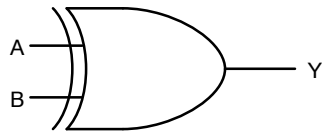

86 - XOR

A	B	Y
0	0	0
0	1	1
1	0	1
1	1	0

Pin Assignment

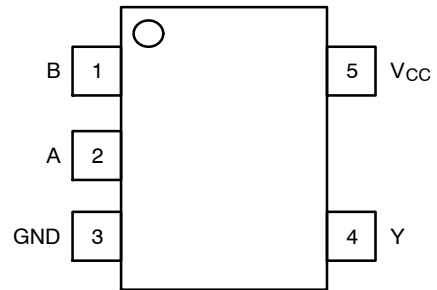

Pinout (Gates)

Pin	Name	Description
1	B	Input
2	A	Input
3	GND	Ground
4	Y	Output
5	V _{CC}	Supply

NLV18HC1Gxx, NLV18HC1GTxx

Table 1. MAXIMUM RATINGS

Symbol	Parameter	Value	Unit	
V _{CC}	DC Supply Voltage	-0.5 to +6.5	V	
V _{IN}	DC Input Voltage	-0.5 to V _{CC} +0.5	V	
V _{OUT}	DC Output Voltage	-0.5 to V _{CC} +0.5	V	
I _{IK}	DC Input Diode Current	±20	mA	
I _{OK}	DC Output Diode Current	±20	mA	
I _{OUT}	DC Output Source/Sink Current	±12.5	mA	
I _{CC} or I _{GND}	DC Supply Current Per Supply Pin or Ground Pin	±25	mA	
T _{STG}	Storage Temperature Range	-65 to +150	°C	
T _L	Lead Temperature, 1 mm from Case for 10 Seconds	260	°C	
T _J	Junction Temperature Under Bias	+150	°C	
θ _{JA}	Thermal Resistance (Note 1)	659	°C/W	
P _D	Power Dissipation in Still Air at 85°C	190	mW	
MSL	Moisture Sensitivity	Level 1		
F _R	Flammability Rating	Oxygen Index: 28 to 34 UL 94 V-0 @ 0.125 in		
V _{ESD}	ESD Withstand Voltage (Note 2)	Human Body Model Charged Device Model	2000 1000	V
I _{LATCHUP}	Latchup Performance (Note 3)	±100	mA	

Stresses exceeding those listed in the Maximum Ratings table may damage the device. If any of these limits are exceeded, device functionality should not be assumed, damage may occur and reliability may be affected.

1. Measured with minimum pad spacing on an FR4 board, using 10 mm-by-1 inch, 20 ounce copper trace with no air flow.
2. HBM tested to EIA / JESD22-A114-A. CDM tested to JESD22-C101-A. JEDEC recommends that ESD qualification to EIA/JESD22-A115A (Machine Model) be discontinued.
3. Tested to EIA/JESD78 Class II.

Table 2. RECOMMENDED OPERATING CONDITIONS

Symbol	Parameter	Min	Max	Unit	
V _{CC}	Positive DC Supply Voltage	NLV18HC1Gxx	2.0	6.0	V
		NLV18HC1GTxx	4.5	5.5	
V _{IN}	Digital Input Voltage	0	V _{CC}	V	
V _{OUT}	Output Voltage	0	V _{CC}	V	
T _A	Operating Free-Air Temperature	-55	+125	°C	
t _r , t _f	Input Transition Rise or Fall Rate			ns/V	
	Functions 14 and 17	0	No Limit		
	All Other Functions	V _{CC} = 1.65 V to 1.95 V	0		20
		V _{CC} = 2.3 V to 2.7 V	0		20
		V _{CC} = 3.0 V to 3.6 V	0		10
V _{CC} = 4.5 V to 5.5 V		0	5		

Functional operation above the stresses listed in the Recommended Operating Ranges is not implied. Extended exposure to stresses beyond the Recommended Operating Ranges limits may affect device reliability.

NLV18HC1Gxx, NLV18HC1GTxx

Table 3. DC ELECTRICAL CHARACTERISTICS (NLV18HC1Gxx)

Symbol	Parameter	Conditions	V _{CC} (V)	T _A = 25°C			T _A = -40°C to 85°C		T _A = -55°C to +125°C		Unit
				Min	Typ	Max	Min	Max	Min	Max	
NLV18HC1G14 and NLV18HC1G17											
V _{T+}	Positive-Going Threshold		2.0	-	1.29	1.5	-	1.5	-	1.5	V
			3.0	-	1.91	2.20	-	2.20	-	2.20	
			4.5	-	2.77	3.15	-	3.15	-	3.15	
			5.5	-	3.37	3.85	-	3.85	-	3.85	
V _{T-}	Negative-Going Threshold		2.0	0.5	0.75	-	0.5	-	0.5	-	V
			3.0	0.9	1.2	-	0.9	-	0.9	-	
			4.5	1.35	1.91	-	1.35	-	1.35	-	
			5.5	1.65	2.38	-	1.65	-	1.65	-	
V _H	Hysteresis Voltage		2.0	0.2	0.55	1.0	0.2	1.0	0.2	1.0	V
			3.0	0.3	0.7	1.2	0.3	1.2	0.3	1.2	
			4.5	0.4	0.86	1.4	0.4	1.4	0.4	1.4	
			5.5	0.5	0.98	1.6	0.5	1.6	0.5	1.6	
NLV18HC1GU04 (Under Development)											
V _{IH}	High- Level Input Voltage		2.0	TBD	-	-	TBD	-	TBD	-	V
			3.0	TBD	-	-	TBD	-	TBD	-	
			4.5	TBD	-	-	TBD	-	TBD	-	
			6.0	TBD	-	-	TBD	-	TBD	-	
V _{IL}	Low- Level Input Voltage		2.0	-	-	TBD	-	TBD	-	TBD	V
			3.0	-	-	TBD	-	TBD	-	TBD	
			4.5	-	-	TBD	-	TBD	-	TBD	
			6.0	-	-	TBD	-	TBD	-	TBD	
ALL OTHER PARTS											
V _{IH}	High- Level Input Voltage		2.0	1.5	-	-	1.5	-	1.5	-	V
			3.0	2.1	-	-	2.1	-	2.1	-	
			4.5	3.15	-	-	3.15	-	3.15	-	
			6.0	4.20	-	-	4.20	-	4.20	-	
V _{IL}	Low- Level Input Voltage		2.0	-	-	0.5	-	0.5	-	0.5	V
			3.0	-	-	0.9	-	0.9	-	0.9	
			4.5	-	-	1.35	-	1.35	-	1.35	
			6.0	-	-	1.80	-	1.80	-	1.80	
ALL PARTS											
V _{OH} (Note 4)	High- Level Output Voltage	V _{IN} = V _{IH} (V _{T+}) or V _{IL} (V _{T-}) I _{OH} = -20 μA	2.0	1.9	2.0	-	1.9	-	1.9	-	V
			3.0	2.9	3.0	-	2.9	-	2.9	-	
			4.5	4.4	4.5	-	4.4	-	4.4	-	
			6.0	5.9	6.0	-	5.9	-	5.9	-	
		V _{IN} = V _{IH} (V _{T+}) or V _{IL} (V _{T-}) I _{OH} = -2 mA I _{OH} = -2.6 mA	4.5	4.18	4.31	-	4.13	-	4.08	-	
			6.0	5.68	5.80	-	5.63	-	5.58	-	

NLV18HC1Gxx, NLV18HC1GTxx

Table 3. DC ELECTRICAL CHARACTERISTICS (NLV18HC1Gxx)

Symbol	Parameter	Conditions	V _{CC} (V)	T _A = 25°C			T _A = -40°C to 85°C		T _A = -55°C to +125°C		Unit
				Min	Typ	Max	Min	Max	Min	Max	
ALL PARTS											
V _{OL}	Low- Level Output Voltage	V _{IN} = V _{IH} (V _{T+}) or V _{IL} (V _{T-}) I _{OL} = 20 μA	2.0	-	0.0	0.1	-	0.1	-	0.1	V
			3.0	-	0.0	0.1	-	0.1	-	0.1	
			4.5	-	0.0	0.1	-	0.1	-	0.1	
			6.0	-	0.0	0.1	-	0.1	-	0.1	
		V _{IN} = V _{IH} (V _{T+}) or V _{IL} (V _{T-}) I _{OL} = 2 mA I _{OL} = 2.6 mA	4.5	-	0.17	0.26	-	0.33	-	0.40	
			6.0	-	0.18	0.26	-	0.33	-	0.40	
I _{IN}	Input Leakage Current	V _{IN} = 6.0 V or GND	6.0	-	-	±0.1	-	±1.0	-	±1.0	μA
I _{CC}	Quiescent Supply Current	V _{IN} = V _{CC} or GND	6.0	-	-	1.0	-	10	-	40	μA

Product parametric performance is indicated in the Electrical Characteristics for the listed test conditions, unless otherwise noted. Product performance may not be indicated by the Electrical Characteristics if operated under different conditions.

4. The V_{OH} parameter does not apply to devices with open-drain output, NLV18HC1G05, NLV18HC1G07, NLV18HC1GT05 and NLV18HC1GT07.

Table 4. DC ELECTRICAL CHARACTERISTICS (NLV18HC1GTxx)

Symbol	Parameter	Conditions	V _{CC} (V)	T _A = 25 °C			T _A = -40°C to 85°C		T _A = -55°C to +125°C		Unit
				Min	Typ	Max	Min	Max	Min	Max	
NLV18HC1GT14 and NLV18HC1GT17											
V _{T+}	Positive-Going Threshold		4.5	-	1.64	2.0	-	2.0	-	2.0	V
			5.5	-	1.85	2.1	-	2.1	-	2.1	
V _{T-}	Negative-Going Threshold		4.5	0.5	1.0	-	0.5	-	0.5	-	V
			5.5	0.6	1.14	-	0.6	-	0.6	-	
V _H	Hysteresis Voltage		4.5	0.4	0.64	1.4	0.4	1.4	0.4	1.4	V
			5.5	0.5	0.71	1.6	0.5	1.6	0.5	1.6	
ALL OTHER PARTS											
V _{IH}	High- Level Input Voltage		4.5 – 5.5	2.0	-	-	2.0	-	2.0	-	V
V _{IL}	Low- Level Input Voltage		4.5 – 5.5	-	-	0.8	-	0.8	-	0.8	V
ALL PARTS											
V _{OH} (Note 4)	High- Level Output Voltage	V _{IN} = V _{IH} (V _{T+}) or V _{IL} (V _{T-}) I _{OH} = -20 μA I _{OH} = -2 mA	4.5	4.4	4.5	-	4.4	-	4.4	-	V
			4.5	4.18	4.32	-	4.13	-	4.08	-	
			4.5	4.18	4.32	-	4.13	-	4.08	-	
V _{OL}	Low- Level Output Voltage	V _{IN} = V _{IH} (V _{T+}) or V _{IL} (V _{T-}) I _{OL} = 20 μA I _{OL} = 2 mA	4.5	-	0.0	0.1	-	0.1	-	0.1	V
			4.5	-	0.17	0.26	-	0.33	-	0.40	
			4.5	-	0.17	0.26	-	0.33	-	0.40	
I _{IN}	Input Leakage Current	V _{IN} = V _{CC} or GND	5.5	-	-	±0.1	-	±1.0	-	±1.0	μA
I _{CC}	Quiescent Supply Current	V _{IN} = V _{CC} or GND; I _O = 0 A	5.5	-	-	1.0	-	10	-	40	μA
ΔI _{CC}	Additional Supply Current per Input	V _{IN} = V _{CC} - 2.1 V; I _O = 0 A; Other input at V _{CC} or GND	4.5 – 5.5	-	-	1.0	-	1.5	-	1.65	mA

NLV18HC1Gxx, NLV18HC1GTxx

Table 5. AC ELECTRICAL CHARACTERISTICS (NLV18HC1Gxx) (Input $t_r = t_f = 6.0$ ns)

Symbol	Parameter	Test Conditions	V_{CC} (V)	$T_A = 25^\circ\text{C}$			$T_A = -40^\circ\text{C}$ to 85°C		$T_A = -55^\circ\text{C}$ to $+125^\circ\text{C}$		Unit	
				Min	Typ	Max	Min	Max	Min	Max		
t_{PLH} , t_{PHL}	Propagation Delay, (A or B) to Y	$C_L = 15$ pF	5.0	–	3.5	15	–	20	–	25	ns	
			2.0	–	20	100	–	125	–	155		
				3.0	–	11	27	–	35	–		90
				4.5	–	8	20	–	25	–		35
				6.0	–	7	17	–	21	–		26
t_{TLH} , t_{THL}	Output Transition Time	$C_L = 15$ pF	5.0	–	3	10	–	15	–	20	ns	
			2.0	–	25	125	–	155	–	200		
				3.0	–	16	35	–	45	–		60
				4.5	–	11	25	–	31	–		38
				6.0	–	9	21	–	26	–		32
t_{PZH} , t_{PZL} (Note 5)	Enable Time, (A or OE or OE) to Y	$C_L = 50$ pF	2.0	–	19	TBD	–	155	–	190	ns	
			3.0	–	TBD	TBD	–	TBD	–	TBD		
			4.5	–	9	TBD	–	31	–	38		
			6.0	–	7	TBD	–	26	–	32		
t_{PHZ} , t_{PLZ} (Note 5)	Disable Time, (A or OE or OE) to Y	$C_L = 50$ pF	2.0	–	19	TBD	–	155	–	190	ns	
			3.0	–	TBD	TBD	–	TBD	–	TBD		
			4.5	–	9	TBD	–	31	–	38		
			6.0	–	7	TBD	–	26	–	32		
C_{IN}	Input Capacitance			–	5	10	–	10	–	10	pF	

5. These parameters apply only to devices where the output may be tri-stated. These specifications are still under development.

Table 6. AC ELECTRICAL CHARACTERISTICS (NLV18HC1GTxx) (Input $t_r = t_f = 6.0$ ns)

Symbol	Parameter	Test Conditions	V_{CC} (V)	$T_A = 25^\circ\text{C}$			$T_A = -40^\circ\text{C}$ to 85°C		$T_A = -55^\circ\text{C}$ to $+125^\circ\text{C}$		Unit
				Min	Typ	Max	Min	Max	Min	Max	
t_{PLH} , t_{PHL}	Propagation Delay, (A or B) to Y	$C_L = 15$ pF	5.0	–	3.5	15	–	20	–	25	ns
		$C_L = 50$ pF	4.5	–	8	20	–	25	–	35	
t_{TLH} , t_{THL}	Output Transition Time	$C_L = 15$ pF	5.0	–	3	10	–	15	–	20	ns
		$C_L = 50$ pF	4.5	–	11	25	–	31	–	38	
t_{PZH} , t_{PZL} (Note 5)	Enable Time, (A or OE or OE) to Y	$C_L = 50$ pF	4.5	–	9	TBD	–	31	–	38	ns
t_{PHZ} , t_{PLZ} (Note 5)	Disable Time, (A or OE or OE) to Y	$C_L = 50$ pF	4.5	–	9	TBD	–	31	–	38	ns

Table 7. CAPACITANCE

Symbol	Parameter	Typical @ = 25°C , $V_{CC} = 5.0$ V	Unit
C_{IN}	Input Capacitance	5	pF
C_{PD}	Power Dissipation Capacitance (Note 6)	10	pF

6. C_{PD} is defined as the value of the internal equivalent capacitance which is calculated from the dynamic operating current consumption without load. Average operating current can be obtained by the equation $I_{CC(OPR)} = C_{PD} \times V_{CC} \times f_{in} + I_{CC}$. C_{PD} is used to determine the no-load dynamic power consumption; $P_D = C_{PD} \times V_{CC}^2 \times f_{in} + I_{CC} \times V_{CC}$.

NLV18HC1Gxx, NLV18HC1GTxx

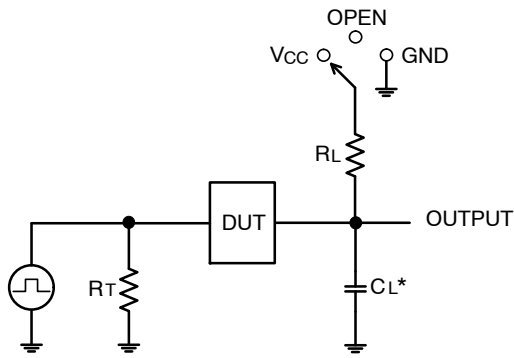

C_L includes probe and jig capacitance
 R_T is Z_{OUT} of pulse generator (typically 50 Ω)
 $f = 1$ MHz

Figure 1. Test Circuit

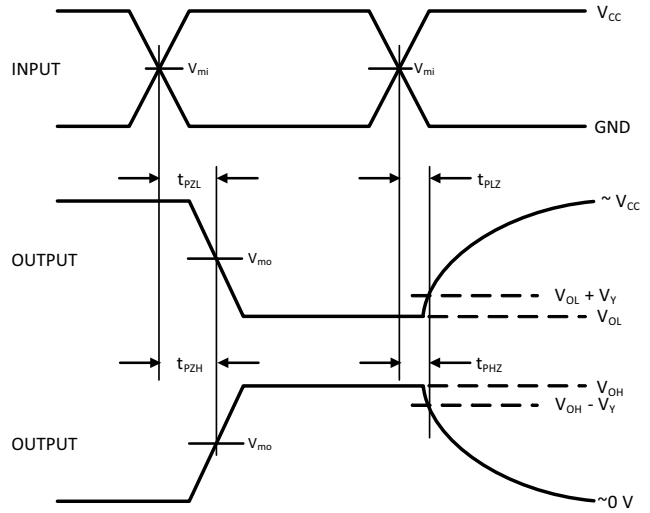
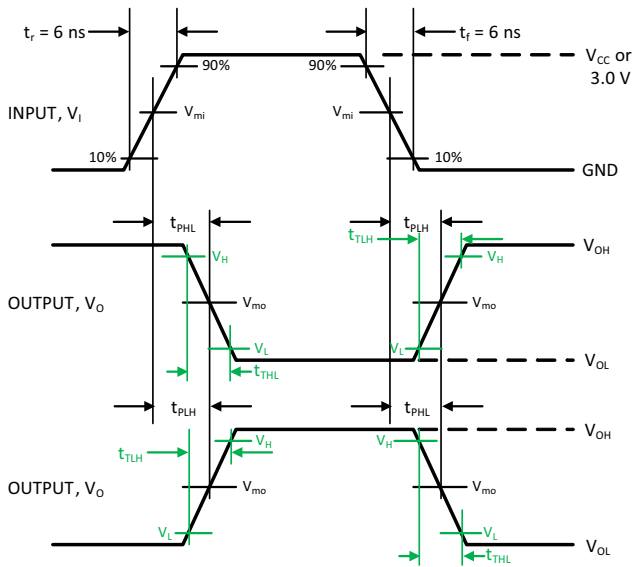

Figure 2. Switching Waveforms

Device Type	Input			Output		
	V_I, V	V_{mi}, V	V_{mo}, V	V_L, V	V_H, V	V_Y, V
NLV18HC1Gxx	GND to V_{CC}	$V_{CC}/2$	$V_{CC}/2$	$V_{OL} + 0.1 (V_{OH} - V_{OL})$	$V_{OL} + 0.9 (V_{OH} - V_{OL})$	0.3
NLV18HC1GTxx	GND to 3.0 V	1.3 V	1.3 V	$V_{OL} + 0.1 (V_{OH} - V_{OL})$	$V_{OL} + 0.9 (V_{OH} - V_{OL})$	0.3

7. t_{TLH} and t_{THL} are measured from 10% to 90% of $(V_{OH} - V_{OL})$, and 90% to 10% of $(V_{OH} - V_{OL})$, respectively.

NLV18HC1Gxx, NLV18HC1GTxx

ORDERING INFORMATION

Device	Package	Marking	Pin 1 Orientation (See below)	Shipping [†]
NLV18HC1G00DFT2G (in development)	SC-88A	TBD	Q4	3000 / Tape & Reel
NLV18HC1G02DFT2G (in development)	SC-88A	TBD	Q4	3000 / Tape & Reel
NLV18HC1G04DFT2G (in development)	SC-88A	TBD	Q4	3000 / Tape & Reel
NLV18HC1G05DFT2G (in development)	SC-88A	TBD	Q4	3000 / Tape & Reel
NLV18HC1G07DFT2G (in development)	SC-88A	TBD	Q4	3000 / Tape & Reel
NLV18HC1G08DFT2G	SC-88A	H2	Q4	3000 / Tape & Reel
NLV18HC1G14DFT2G (in development)	SC-88A	TBD	Q4	3000 / Tape & Reel
NLV18HC1G17DFT2G (in development)	SC-88A	TBD	Q4	3000 / Tape & Reel
NLV18HC1G32DFT2G	SC-88A	H4	Q4	3000 / Tape & Reel
NLV18HC1G34DFT2G (in development)	SC-88A	TBD	Q4	3000 / Tape & Reel
NLV18HC1G86DFT2G (in development)	SC-88A	TBD	Q4	3000 / Tape & Reel
NLV18HC1G125DFT2G (in development)	SC-88A	TBD	Q4	3000 / Tape & Reel
NLV18HC1G126DFT2G (in development)	SC-88A	TBD	Q4	3000 / Tape & Reel
NLV18HC1GU04DFT2G (in development)	SC-88A	TBD	Q4	3000 / Tape & Reel
NLV18HC1GT00DFT2G (in development)	SC-88A	TBD	Q4	3000 / Tape & Reel
NLV18HC1GT02DFT2G (in development)	SC-88A	TBD	Q4	3000 / Tape & Reel
NLV18HC1GT04DFT2G (in development)	SC-88A	TBD	Q4	3000 / Tape & Reel
NLV18HC1GT05DFT2G (in development)	SC-88A	TBD	Q4	3000 / Tape & Reel
NLV18HC1GT07DFT2G (in development)	SC-88A	TBD	Q4	3000 / Tape & Reel
NLV18HC1GT08DFT2G (in development)	SC-88A	TBD	Q4	3000 / Tape & Reel
NLV18HC1GT14DFT2G (in development)	SC-88A	TBD	Q4	3000 / Tape & Reel
NLV18HC1GT17DFT2G (in development)	SC-88A	TBD	Q4	3000 / Tape & Reel
NLV18HC1GT32DFT2G (in development)	SC-88A	TBD	Q4	3000 / Tape & Reel
NLV18HC1GT34DFT2G (in development)	SC-88A	TBD	Q4	3000 / Tape & Reel
NLV18HC1GT86DFT2G (in development)	SC-88A	TBD	Q4	3000 / Tape & Reel
NLV18HC1GT125DFT2G (in development)	SC-88A	TBD	Q4	3000 / Tape & Reel
NLV18HC1GT126DFT2G (in development)	SC-88A	TBD	Q4	3000 / Tape & Reel

[†]For information on tape and reel specifications, including part orientation and tape sizes, please refer to our Tape and Reel Packaging Specifications Brochure, BRD8011/D.

*NLV Prefix for Automotive and Other Applications Requiring Unique Site and Control Change Requirements; AEC-Q100 Qualified and PPAP Capable.

Pin 1 Orientation in Tape and Reel

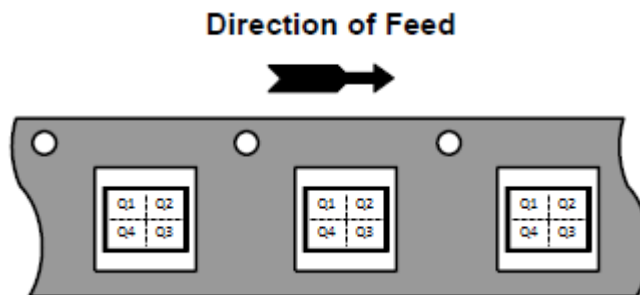

NLV18HC1Gxx, NLV18HC1GTxx

PACKAGE DIMENSIONS

SC-88A (SC-70-5/SOT-353)
CASE 419A-02
ISSUE L

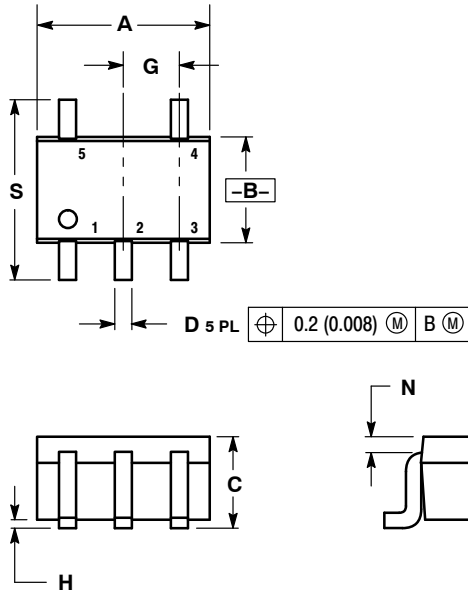

NOTES:

1. DIMENSIONING AND TOLERANCING PER ANSI Y14.5M, 1982.
2. CONTROLLING DIMENSION: INCH.
3. 419A-01 OBSOLETE. NEW STANDARD 419A-02.
4. DIMENSIONS A AND B DO NOT INCLUDE MOLD FLASH, PROTRUSIONS, OR GATE BURRS.

DIM	INCHES		MILLIMETERS	
	MIN	MAX	MIN	MAX
A	0.071	0.087	1.80	2.20
B	0.045	0.053	1.15	1.35
C	0.031	0.043	0.80	1.10
D	0.004	0.012	0.10	0.30
G	0.026 BSC		0.65 BSC	
H	---	0.004	---	0.10
J	0.004	0.010	0.10	0.25
K	0.004	0.012	0.10	0.30
N	0.008 REF		0.20 REF	
S	0.079	0.087	2.00	2.20

SOLDER FOOTPRINT

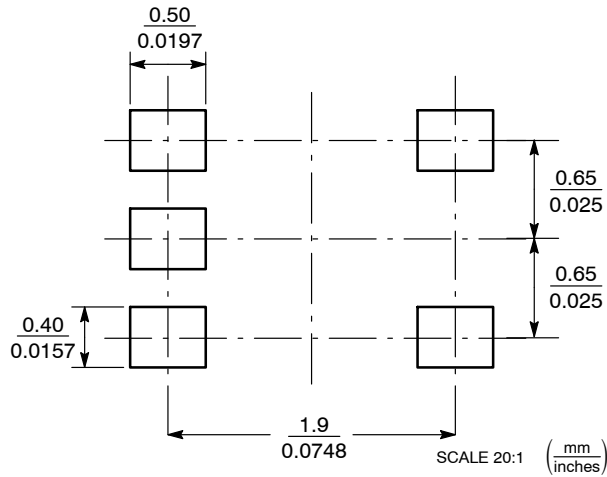

ON Semiconductor and are trademarks of Semiconductor Components Industries, LLC dba ON Semiconductor or its subsidiaries in the United States and/or other countries. ON Semiconductor owns the rights to a number of patents, trademarks, copyrights, trade secrets, and other intellectual property. A listing of ON Semiconductor's product/patent coverage may be accessed at www.onsemi.com/site/pdf/Patent-Marking.pdf. ON Semiconductor reserves the right to make changes without further notice to any products herein. ON Semiconductor makes no warranty, representation or guarantee regarding the suitability of its products for any particular purpose, nor does ON Semiconductor assume any liability arising out of the application or use of any product or circuit, and specifically disclaims any and all liability, including without limitation special, consequential or incidental damages. Buyer is responsible for its products and applications using ON Semiconductor products, including compliance with all laws, regulations and safety requirements or standards, regardless of any support or applications information provided by ON Semiconductor. "Typical" parameters which may be provided in ON Semiconductor data sheets and/or specifications can and do vary in different applications and actual performance may vary over time. All operating parameters, including "Typicals" must be validated for each customer application by customer's technical experts. ON Semiconductor does not convey any license under its patent rights nor the rights of others. ON Semiconductor products are not designed, intended, or authorized for use as a critical component in life support systems or any FDA Class 3 medical devices or medical devices with a same or similar classification in a foreign jurisdiction or any devices intended for implantation in the human body. Should Buyer purchase or use ON Semiconductor products for any such unintended or unauthorized application, Buyer shall indemnify and hold ON Semiconductor and its officers, employees, subsidiaries, affiliates, and distributors harmless against all claims, costs, damages, and expenses, and reasonable attorney fees arising out of, directly or indirectly, any claim of personal injury or death associated with such unintended or unauthorized use, even if such claim alleges that ON Semiconductor was negligent regarding the design or manufacture of the part. ON Semiconductor is an Equal Opportunity/Affirmative Action Employer. This literature is subject to all applicable copyright laws and is not for resale in any manner.

PUBLICATION ORDERING INFORMATION

LITERATURE FULFILLMENT:
Literature Distribution Center for ON Semiconductor
19521 E. 32nd Pkwy, Aurora, Colorado 80011 USA
Phone: 303-675-2175 or 800-344-3860 Toll Free USA/Canada
Fax: 303-675-2176 or 800-344-3867 Toll Free USA/Canada
Email: orderlit@onsemi.com

N. American Technical Support: 800-282-9855 Toll Free
USA/Canada
Europe, Middle East and Africa Technical Support:
Phone: 421 33 790 2910

ON Semiconductor Website: www.onsemi.com
Order Literature: <http://www.onsemi.com/orderlit>

For additional information, please contact your local Sales Representative

X-ON Electronics

Largest Supplier of Electrical and Electronic Components

Click to view similar products for [Logic Gates](#) category:

Click to view products by [ON Semiconductor](#) manufacturer:

Other Similar products are found below :

[74HC85N](#) [NLU1G32AMUTCG](#) [NLV7SZ58DFT2G](#) [CD4068BE](#) [NL17SG32P5T5G](#) [NL17SG86DFT2G](#) [NLV14001UBDR2G](#)

[NLX1G11AMUTCG](#) [NLX1G97MUTCG](#) [74LS38](#) [74LVC32ADTR2G](#) [MC74HCT20ADTR2G](#) [NLV17SZ00DFT2G](#) [NLV17SZ02DFT2G](#)

[NLV74HC02ADR2G](#) [74HC32S14-13](#) [74LS133](#) [74LVC1G32Z-7](#) [M38510/30402BDA](#) [74LVC1G86Z-7](#) [74LVC2G08RA3-7](#)

[NLV74HC08ADTR2G](#) [NLV74HC14ADR2G](#) [NLV74HC20ADR2G](#) [NLX2G86MUTCG](#) [5962-8973601DA](#) [74LVC2G02HD4-7](#)

[NLU1G00AMUTCG](#) [74LVC2G32RA3-7](#) [74LVC2G00HD4-7](#) [NL17SG02P5T5G](#) [74LVC2G00HK3-7](#) [74LVC2G86HK3-7](#)

[NLX1G99DMUTWG](#) [NLVVHC1G00DFT2G](#) [NLVHC1G08DFT2G](#) [NLV7SZ57DFT2G](#) [NLV74VHC04DTR2G](#) [NLV27WZ86USG](#)

[NLV27WZ00USG](#) [NLU1G86CMUTCG](#) [NLU1G08CMUTCG](#) [NL17SZ32P5T5G](#) [NL17SZ00P5T5G](#) [NL17SH02P5T5G](#) [74AUP2G00RA3-7](#)

[NLV74HC02ADTR2G](#) [NLX1G332CMUTCG](#) [NL17SG86P5T5G](#) [NL17SZ05P5T5G](#)