

NRTSV30H120CT

Low Forward Voltage Trench-based Schottky Rectifier

Features

- Fine Lithography Trench-based Schottky Technology for Very Low Forward Voltage and Low Leakage
- Fast Switching with Exceptional Temperature Stability
- Low Power Loss and Lower Operating Temperature
- Higher Efficiency for Achieving Regulatory Compliance
- Low Thermal Resistance
- High Surge Capability
- These Devices are Pb-Free, Halogen Free/BFR Free and are RoHS Compliant

Typical Applications

- Switching Power Supplies including Notebook / Netbook Adapters, ATX and Flat Panel Display
- High Frequency and DC-DC Converters
- Freewheeling and OR-ing diodes
- Reverse Battery Protection
- Instrumentation

Mechanical Characteristics

- Case: Epoxy, Molded
- Epoxy Meets Flammability Rating UL 94-0 @ 0.125 in
- Finish: All External Surfaces Corrosion Resistant and Terminal Leads are Readily Solderable
- Lead Temperature for Soldering Purposes: 260°C Maximum for 10 sec



ON Semiconductor®

www.onsemi.com

PIN CONNECTIONS

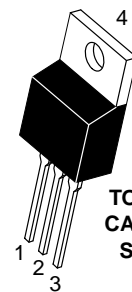
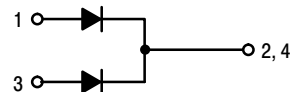

TO-220AB
CASE 221A
STYLE 6

MARKING DIAGRAM

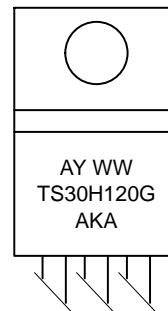

TS30H120G = Specific Device Code
A = Assembly Location
Y = Year
WW = Work Week
AKA = Polarity Designator
G = Pb-Free Package

ORDERING INFORMATION

See detailed ordering and shipping information on page 2 of this data sheet.

NRTSV30H120CT

MAXIMUM RATINGS

| Rating | Symbol | Value | Unit |
|---|--|-------------|------------------|
| Peak Repetitive Reverse Voltage Working Peak Reverse Voltage DC Blocking Voltage | V_{RRM} V_{RWM} V_R | 120 | V |
| Average Rectified Forward Current (Rated V_R , $T_C = 124^\circ\text{C}$) (Rated V_R , $T_C = 134^\circ\text{C}$) | $I_{F(AV)}$ Per device Per diode | 30 15 | A |
| Peak Repetitive Forward Current (Rated V_R , Square Wave, 20 kHz, $T_C = 119^\circ\text{C}$) (Rated V_R , Square Wave, 20 kHz, $T_C = 132^\circ\text{C}$) | I_{FRM} Per device Per diode | 60 30 | A |
| Nonrepetitive Peak Surge Current (Surge applied at rated load conditions halfwave, single phase, 60 Hz) | I_{FSM} | 125 | A |
| Operating Junction Temperature | T_J | -55 to +150 | $^\circ\text{C}$ |
| Storage Temperature | T_{stg} | -55 to +150 | $^\circ\text{C}$ |

Stresses exceeding those listed in the Maximum Ratings table may damage the device. If any of these limits are exceeded, device functionality should not be assumed, damage may occur and reliability may be affected.

THERMAL CHARACTERISTICS

| Rating | Symbol | Value | Unit |
|---|------------------------------------|-------------|--|
| Maximum Thermal Resistance per Device (Note 1) Junction-to-Case Junction-to-Ambient | $R_{\theta JC}$ $R_{\theta JA}$ | 1.0 69.3 | $^\circ\text{C/W}$ $^\circ\text{C/W}$ |

1. Assumes 150 mm² 1 oz. copper bond pad, on a FR4 board.

ELECTRICAL CHARACTERISTICS (Per Leg unless otherwise noted)

| Rating | Symbol | Typ | Max | Unit |
|--|--------|----------------------------------|----------------------------|--|
| Maximum Instantaneous Forward Voltage (Note 2) ($I_F = 7.5\text{ A}$, $T_J = 25^\circ\text{C}$) ($I_F = 15\text{ A}$, $T_J = 25^\circ\text{C}$) ($I_F = 7.5\text{ A}$, $T_J = 125^\circ\text{C}$) ($I_F = 15\text{ A}$, $T_J = 125^\circ\text{C}$) | V_F | 0.65 0.87 0.56 0.66 | - 0.93 - 0.70 | V |
| Maximum Instantaneous Reverse Current (Note 2) ($V_R = 90\text{ V}$, $T_J = 25^\circ\text{C}$) ($V_R = 90\text{ V}$, $T_J = 125^\circ\text{C}$) (Rated dc Voltage, $T_J = 25^\circ\text{C}$) (Rated dc Voltage, $T_J = 125^\circ\text{C}$) | I_R | 3.8 4.3 8.6 7.2 | 35 15 | μA mA μA mA |
| Diode Capacitance (Rated dc Voltage, $T_J = 25^\circ\text{C}$) | C_d | 95 | - | pF |

Product parametric performance is indicated in the Electrical Characteristics for the listed test conditions, unless otherwise noted. Product performance may not be indicated by the Electrical Characteristics if operated under different conditions.

2. Pulse Test: Pulse Width = 300 μs , Duty Cycle $\leq 2.0\%$

ORDERING INFORMATION

| Device | Package | Shipping |
|----------------|-----------------------|-----------------|
| NRTSV30H120CTG | TO-220AB (Pb-Free) | 50 Units / Rail |

NRTSV30H120CT

TYPICAL CHARACTERISTICS

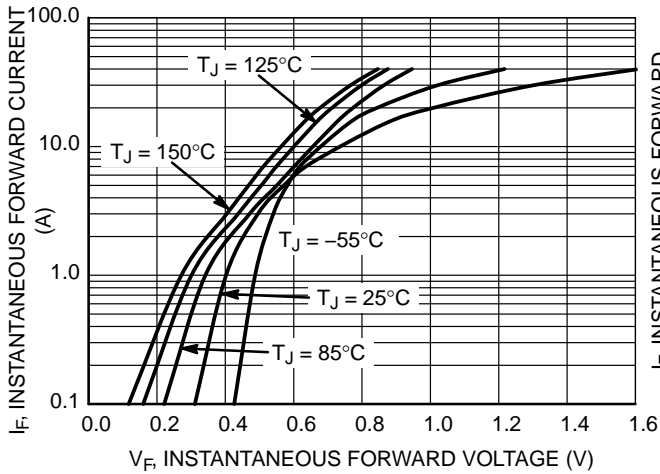

Figure 1. Typical Instantaneous Forward Characteristics

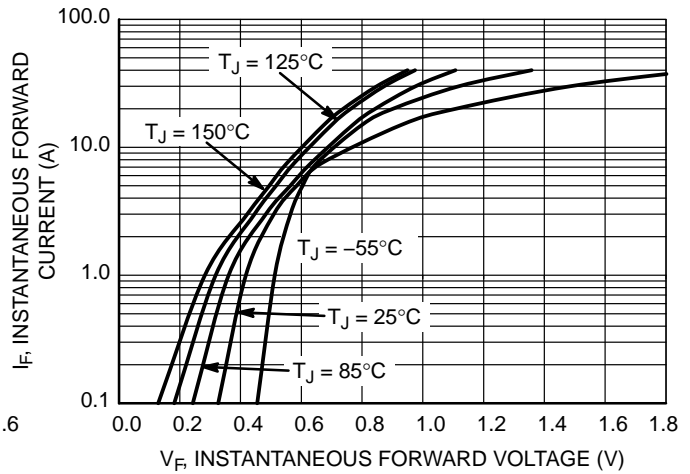

Figure 2. Maximum Instantaneous Forward Characteristics

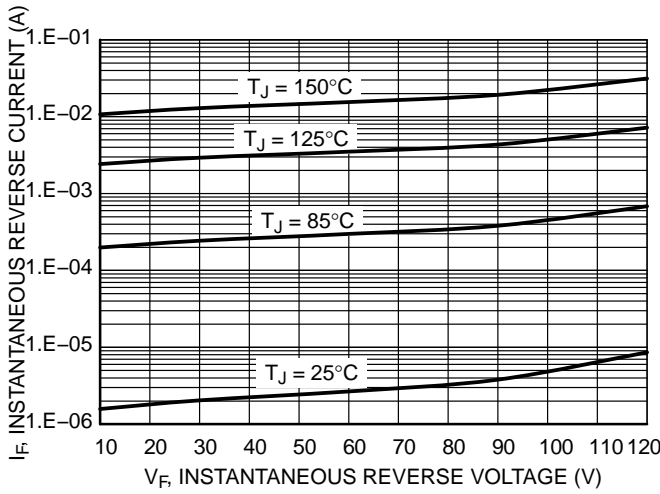

Figure 3. Typical Reverse Characteristics

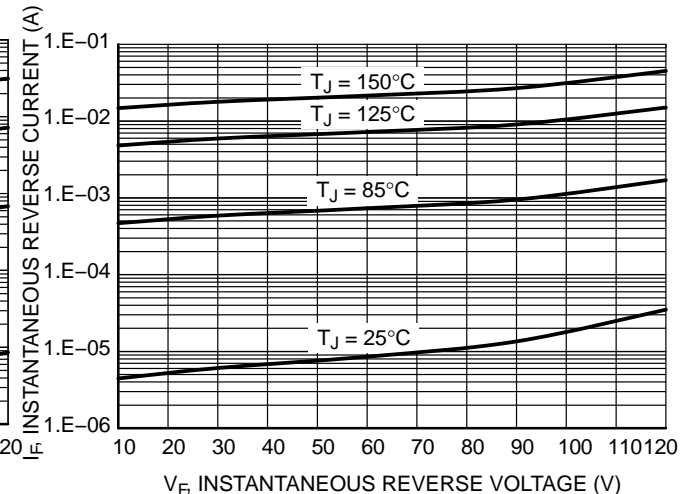

Figure 4. Maximum Reverse Characteristics

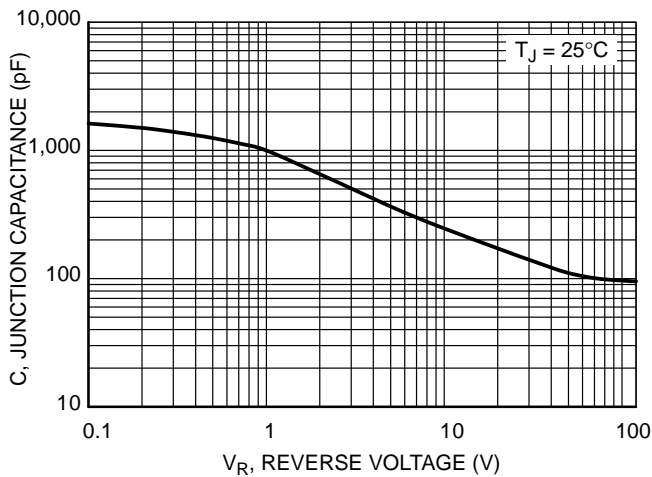

Figure 5. Typical Junction Capacitance

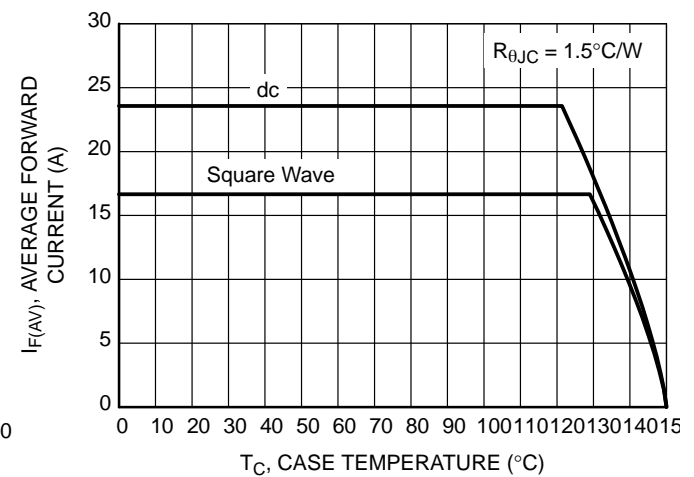

Figure 6. Current Derating per Leg

NRTSV30H120CT

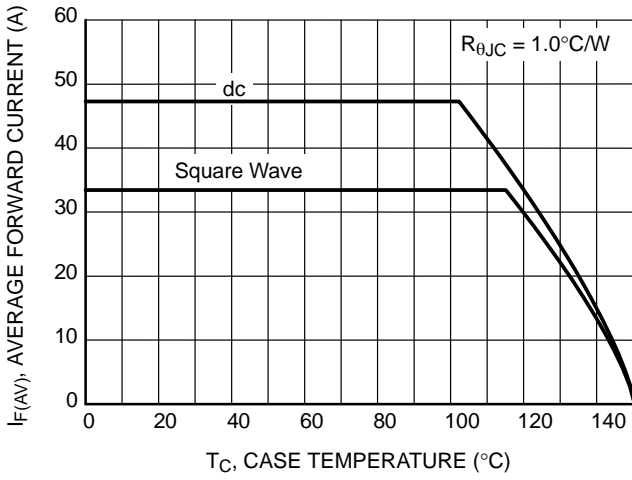

Figure 7. Current Derating, per Device

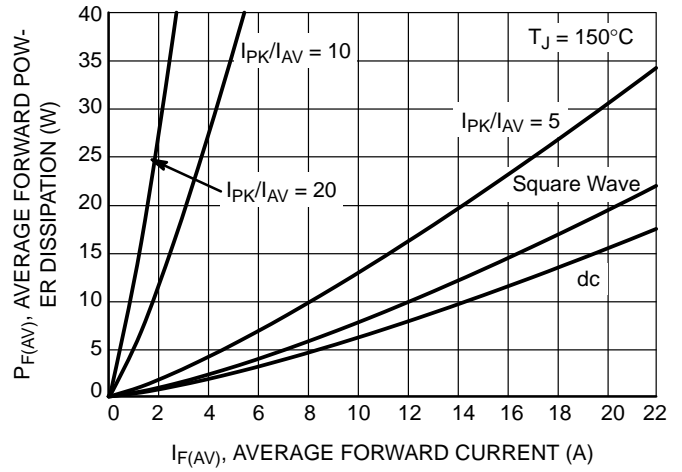

Figure 8. Forward Power Dissipation

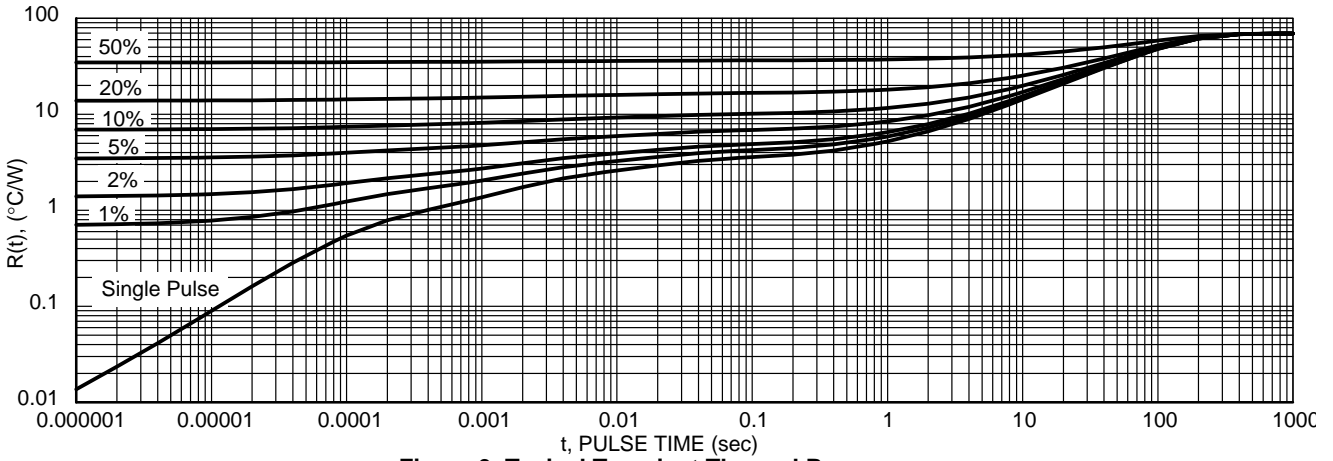
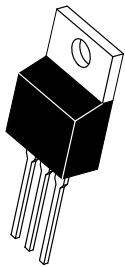
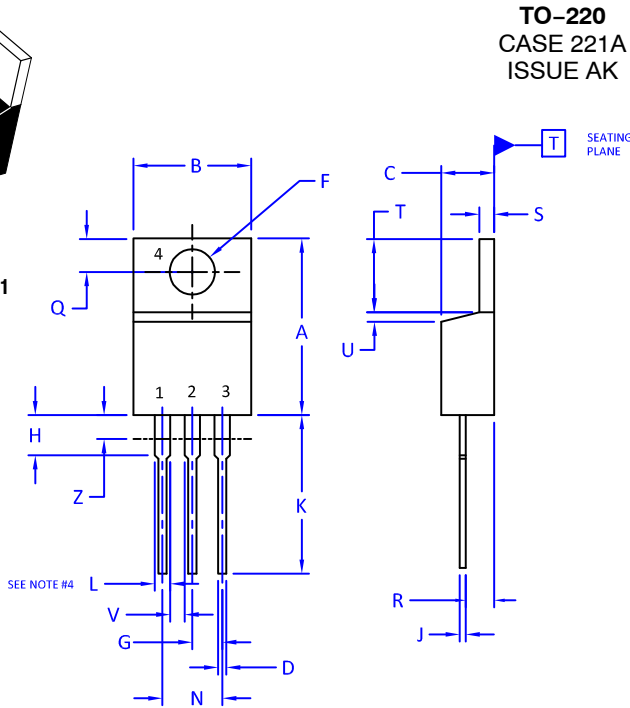

Figure 9. Typical Transient Thermal Response

MECHANICAL CASE OUTLINE PACKAGE DIMENSIONS



SCALE 1:1



TO-220 CASE 221A ISSUE AK

DATE 13 JAN 2022

NOTES:

1. DIMENSIONING AND TOLERANCING PER ANSI Y14.5M, 2009.
2. CONTROLLING DIMENSION: INCHES
3. DIMENSION Z DEFINES A ZONE WHERE ALL BODY AND LEAD IRREGULARITIES ARE ALLOWED.
4. MAX WIDTH FOR F102 DEVICE = 1.35MM

| DIM | INCHES | | MILLIMETERS | |
|-----|--------|-------|-------------|-------|
| | MIN. | MAX. | MIN. | MAX. |
| A | 0.570 | 0.620 | 14.48 | 15.75 |
| B | 0.380 | 0.415 | 9.66 | 10.53 |
| C | 0.160 | 0.190 | 4.07 | 4.83 |
| D | 0.025 | 0.038 | 0.64 | 0.96 |
| F | 0.142 | 0.161 | 3.60 | 4.09 |
| G | 0.095 | 0.105 | 2.42 | 2.66 |
| H | 0.110 | 0.161 | 2.80 | 4.10 |
| J | 0.014 | 0.024 | 0.36 | 0.61 |
| K | 0.500 | 0.562 | 12.70 | 14.27 |
| L | 0.045 | 0.060 | 1.15 | 1.52 |
| N | 0.190 | 0.210 | 4.83 | 5.33 |
| Q | 0.100 | 0.120 | 2.54 | 3.04 |
| R | 0.080 | 0.110 | 2.04 | 2.79 |
| S | 0.045 | 0.055 | 1.15 | 1.41 |
| T | 0.235 | 0.255 | 5.97 | 6.47 |
| U | 0.000 | 0.050 | 0.00 | 1.27 |
| V | 0.045 | --- | 1.15 | --- |
| Z | --- | 0.080 | --- | 2.04 |

STYLE 1:
PIN 1. BASE
2. COLLECTOR
3. EMITTER
4. COLLECTOR

STYLE 2:
PIN 1. BASE
2. EMITTER
3. COLLECTOR
4. EMITTER

STYLE 3:
PIN 1. CATHODE
2. ANODE
3. GATE
4. ANODE

STYLE 4:
PIN 1. MAIN TERMINAL 1
2. MAIN TERMINAL 2
3. GATE
4. MAIN TERMINAL 2

STYLE 5:
PIN 1. GATE
2. DRAIN
3. SOURCE
4. DRAIN

STYLE 6:
PIN 1. ANODE
2. CATHODE
3. ANODE
4. CATHODE

STYLE 7:
PIN 1. CATHODE
2. ANODE
3. CATHODE
4. ANODE

STYLE 8:
PIN 1. CATHODE
2. ANODE
3. EXTERNAL TRIP/DELAY
4. ANODE

STYLE 9:
PIN 1. GATE
2. COLLECTOR
3. EMITTER
4. COLLECTOR

STYLE 10:
PIN 1. GATE
2. SOURCE
3. DRAIN
4. SOURCE

STYLE 11:
PIN 1. DRAIN
2. SOURCE
3. GATE
4. SOURCE

STYLE 12:
PIN 1. MAIN TERMINAL 1
2. MAIN TERMINAL 2
3. GATE
4. NOT CONNECTED

| | | |
|------------------|-------------|--|
| DOCUMENT NUMBER: | 98ASB42148B | Electronic versions are uncontrolled except when accessed directly from the Document Repository. Printed versions are uncontrolled except when stamped "CONTROLLED COPY" in red. |
| DESCRIPTION: | TO-220 | PAGE 1 OF 1 |

onsemi and onsemi are trademarks of Semiconductor Components Industries, LLC dba onsemi or its subsidiaries in the United States and/or other countries. onsemi reserves the right to make changes without further notice to any products herein. onsemi makes no warranty, representation or guarantee regarding the suitability of its products for any particular purpose, nor does onsemi assume any liability arising out of the application or use of any product or circuit, and specifically disclaims any and all liability, including without limitation special, consequential or incidental damages. onsemi does not convey any license under its patent rights nor the rights of others.

onsemi, **Onsemi**, and other names, marks, and brands are registered and/or common law trademarks of Semiconductor Components Industries, LLC dba "**onsemi**" or its affiliates and/or subsidiaries in the United States and/or other countries. **onsemi** owns the rights to a number of patents, trademarks, copyrights, trade secrets, and other intellectual property. A listing of **onsemi**'s product/patent coverage may be accessed at www.onsemi.com/site/pdf/Patent-Marking.pdf. **onsemi** reserves the right to make changes at any time to any products or information herein, without notice. The information herein is provided "as-is" and **onsemi** makes no warranty, representation or guarantee regarding the accuracy of the information, product features, availability, functionality, or suitability of its products for any particular purpose, nor does **onsemi** assume any liability arising out of the application or use of any product or circuit, and specifically disclaims any and all liability, including without limitation special, consequential or incidental damages. Buyer is responsible for its products and applications using **onsemi** products, including compliance with all laws, regulations and safety requirements or standards, regardless of any support or applications information provided by **onsemi**. "Typical" parameters which may be provided in **onsemi** data sheets and/or specifications can and do vary in different applications and actual performance may vary over time. All operating parameters, including "Typicals" must be validated for each customer application by customer's technical experts. **onsemi** does not convey any license under any of its intellectual property rights nor the rights of others. **onsemi** products are not designed, intended, or authorized for use as a critical component in life support systems or any FDA Class 3 medical devices or medical devices with a same or similar classification in a foreign jurisdiction or any devices intended for implantation in the human body. Should Buyer purchase or use **onsemi** products for any such unintended or unauthorized application, Buyer shall indemnify and hold **onsemi** and its officers, employees, subsidiaries, affiliates, and distributors harmless against all claims, costs, damages, and expenses, and reasonable attorney fees arising out of, directly or indirectly, any claim of personal injury or death associated with such unintended or unauthorized use, even if such claim alleges that **onsemi** was negligent regarding the design or manufacture of the part. **onsemi** is an Equal Opportunity/Affirmative Action Employer. This literature is subject to all applicable copyright laws and is not for resale in any manner.

PUBLICATION ORDERING INFORMATION

LITERATURE FULFILLMENT:

Email Requests to: orderlit@onsemi.com

onsemi Website: www.onsemi.com

TECHNICAL SUPPORT

North American Technical Support:

Voice Mail: 1 800-282-9855 Toll Free USA/Canada

Phone: 011 421 33 790 2910

Europe, Middle East and Africa Technical Support:

Phone: 00421 33 790 2910

For additional information, please contact your local Sales Representative

X-ON Electronics

Largest Supplier of Electrical and Electronic Components

Click to view similar products for [Schottky Diodes & Rectifiers](#) category:

Click to view products by [ON Semiconductor](#) manufacturer:

Other Similar products are found below :

[MA4E2039](#) [D1FH3-5063](#) [MBR0530L-TP](#) [MBR10100CT-BP](#) [MBR1545CT](#) [MMBD301M3T5G](#) [RB160M-50TR](#) [RB551V-30](#)

[BAS16E6433HTMA1](#) [BAT 54-02LRH E6327](#) [NSR05F40QNXT5G](#) [NTE555](#) [JANS1N6640](#) [SB07-03C-TB-H](#) [SB1003M3-TL-W](#) [SK310-T](#)

[SK32A-LTP](#) [SK34B-TP](#) [SS3003CH-TL-E](#) [GA01SHT18](#) [CRS10I30A\(TE85L,QM](#) [MA4E2501L-1290](#) [MBRB30H30CT-1G](#) [SB007-03C-TB-](#)

[E](#) [SK32A-TP](#) [SK33B-TP](#) [SK38B-TP](#) [NRVBM120LT1G](#) [NTE505](#) [NTSB30U100CT-1G](#) [SS15E-TP](#) [VS-6CWQ10FNHM3](#) [ACDBA1100LR-](#)

[HF](#) [ACDBA1200-HF](#) [ACDBA140-HF](#) [ACDBA2100-HF](#) [ACDBA3100-HF](#) [CDBQC0530L-HF](#) [ACDBA340-HF](#) [ACDBA260LR-HF](#)

[ACDBA1100-HF](#) [SK310B-TP](#) [MA4E2502L-1246](#) [MA4E2502H-1246](#) [NRVBM120ET1G](#) [NSR01L30MXT5G](#) [NTE573](#) [NTE6081](#) [SB560](#)

[PMAD1108-LF](#)