

Surface Mount Schottky Power Rectifier

SMA/SMB Power Surface Mount Package

**MBRS2H100T3G,
NBRS2H100T3G,
NBRS2H100NT3G,
MBRA2H100T3G,
NRVBA2H100T3G,
NRVBA2H100NT3G**

This device employs the Schottky Barrier principle in a metal-to-silicon power rectifier. Features epitaxial construction with oxide passivation and metal overlay contact. Ideally suited for low voltage, high frequency switching power supplies; free wheeling diodes and polarity protection diodes.

Features

- Compact Package with J-Bend Leads Ideal for Automated Handling
- Highly Stable Oxide Passivated Junction
- Guard-Ring for Overvoltage Protection
- Low Forward Voltage Drop
- NBR and NRVB Prefixes for Automotive and Other Applications Requiring Unique Site and Control Change Requirements; AEC-Q101 Qualified and PPAP Capable*

Mechanical Characteristics

- Case: Molded Epoxy
- Epoxy Meets UL 94 V-0 @ 0.125 in
- Weight: 70 mg (SMA), 95 mg (SMB) (Approximately)
- Cathode Polarity Band
- Lead and Mounting Surface Temperature for Soldering Purposes: 260°C Max. for 10 Seconds
- Finish: All External Surfaces Corrosion Resistant and Terminal Leads are Readily Solderable
- ESD Ratings:
 - ◆ Charged Device Model > 1000 V (Class C5)
 - ◆ Human Body Model = 3B
- These Devices are Pb-Free and are RoHS Compliant
- Device Meets MSL1 Requirements

SCHOTTKY BARRIER RECTIFIER

2.0 AMPERES, 100 VOLTS

MARKING DIAGRAMS



SMA
CASE 403D

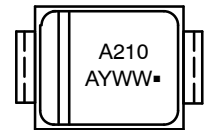

SMB
CASE 403A

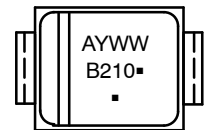

- A210 = MBRA2H100T3G
NRVBA2H100T3G
B210 = MBRS2H100T3G
NBRS2H100T3G
A = Assembly Location
Y = Year
WW = Work Week
▪ = Pb-Free Package

(Note: Microdot may be in either location)

**The Assembly Location code (A) is front side optional. In cases where the Assembly Location is stamped in the package, the front side assembly code may be blank.

ORDERING INFORMATION

Device	Package	Shipping†
MBRA2H100T3G, NRVBA2H100T3G*	SMA (Pb-Free)	5,000 / Tape & Reel
MBRS2H100T3G, NBRS2H100T3G* NBRS2H100NT3G*, NBRS2H100T3G-VF01*	SMB (Pb-Free)	2,500 / Tape & Reel
NRVBA2H100NT3G*	SMA (Pb-Free)	5,000 / Tape & Reel

†For information on tape and reel specifications, including part orientation and tape sizes, please refer to our Tape and Reel Packaging Specifications Brochure, BRD8011/D.

**MBRS2H100T3G, NBRS2H100T3G, NBRS2H100NT3G, MBRA2H100T3G,
NRVBA2H100T3G, NRVBA2H100NT3G**

MAXIMUM RATINGS

Rating	Symbol	Value	Unit
Peak Repetitive Reverse Voltage Working Peak Reverse Voltage DC Blocking Voltage	V_{RRM} V_{RWM} V_R	100	V
Average Rectified Forward Current ($T_L = 150^\circ\text{C}$)	I_O	2.0	A
Non-Repetitive Peak Surge Current (Surge Applied at Rated Load Conditions Halfwave, Single Phase, 60 Hz)	I_{FSM}	130	A
Storage Temperature Range	T_{stg}	-65 to +175	$^\circ\text{C}$
Operating Junction Temperature (Note 1)	T_J	-65 to +175	$^\circ\text{C}$

Stresses exceeding those listed in the Maximum Ratings table may damage the device. If any of these limits are exceeded, device functionality should not be assumed, damage may occur and reliability may be affected.

- The heat generated must be less than the thermal conductivity from Junction-to-Ambient: $dP_D/dT_J < 1/R_{\theta JA}$.

THERMAL CHARACTERISTICS

Characteristic	Symbol	Value	Unit
Thermal Resistance, Junction-to-Lead (Note 2) MBRA2H100T3G, NRVBA2H100T3G, NRVBA2H100NT3G MBRS2H100T3G, NBRS2H100T3G, NBRS2H100NT3G	Ψ_{JCL}	14 12	$^\circ\text{C}/\text{W}$
Thermal Resistance, Junction-to-Ambient (Note 2) MBRA2H100T3G, NRVBA2H100T3G, NRVBA2H100NT3G MBRS2H100T3G, NBRS2H100T3G, NBRS2H100NT3G	$R_{\theta JA}$	75 71	$^\circ\text{C}/\text{W}$
Thermal Resistance, Junction-to-Ambient (Note 3) MBRA2H100T3G, NRVBA2H100T3G, NRVBA2H100NT3G MBRS2H100T3G, NBRS2H100T3G, NBRS2H100NT3G	$R_{\theta JA}$	275 230	$^\circ\text{C}/\text{W}$

- Mounted with 700 mm square copper pad size (Approximately 1 inch square) 1 oz FR4 Board.
- Mounted with minimum recommended pad size 1 oz FR4 Board.

ELECTRICAL CHARACTERISTICS

Characteristic	Symbol	Value		Unit
		$T_J = 25^\circ\text{C}$	$T_J = 125^\circ\text{C}$	
Maximum Instantaneous Forward Voltage (Note 4) ($I_F = 2.0 \text{ A}$)	V_F	0.79	0.65	V
Maximum Instantaneous Reverse Current (Note 4) ($V_R = 100 \text{ V}$)	I_R	0.008	1.5	mA

- Pulse Test: Pulse Width $\leq 380 \mu\text{s}$, Duty Cycle $\leq 2.0\%$.

**MBRS2H100T3G, NBRS2H100T3G, NBRS2H100NT3G, MBRA2H100T3G,
NRVBA2H100T3G, NRVBA2H100NT3G**

TYPICAL CHARACTERISTICS

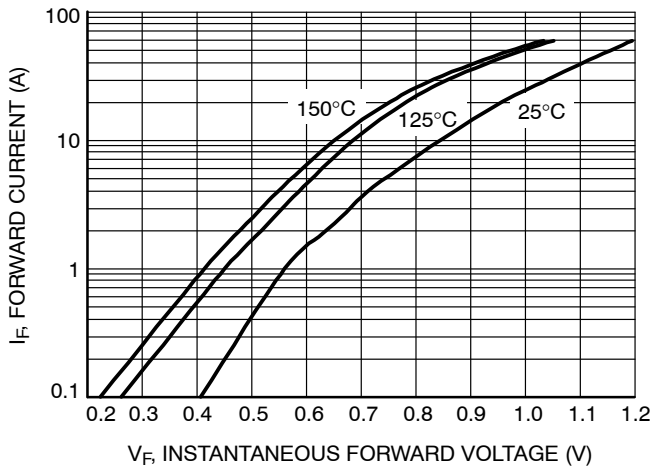

Figure 1. Typical Forward Voltage

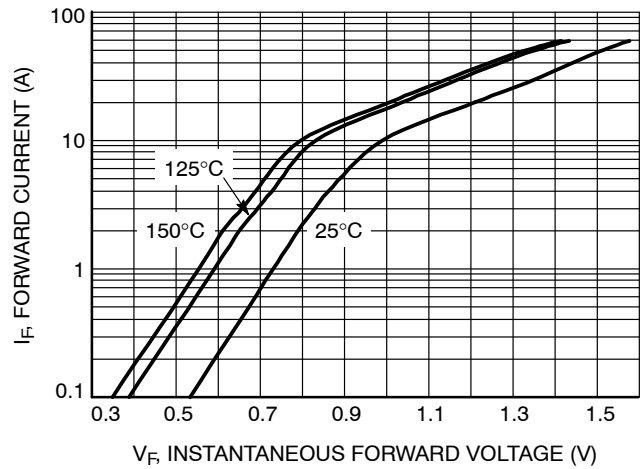

Figure 2. Maximum Forward Voltage

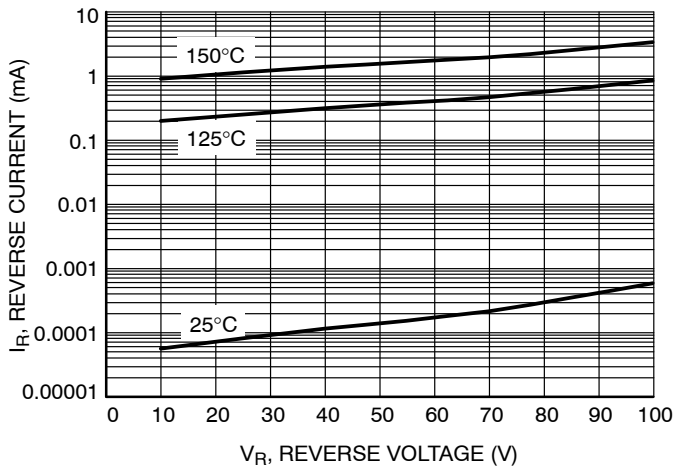

Figure 3. Typical Reverse Current

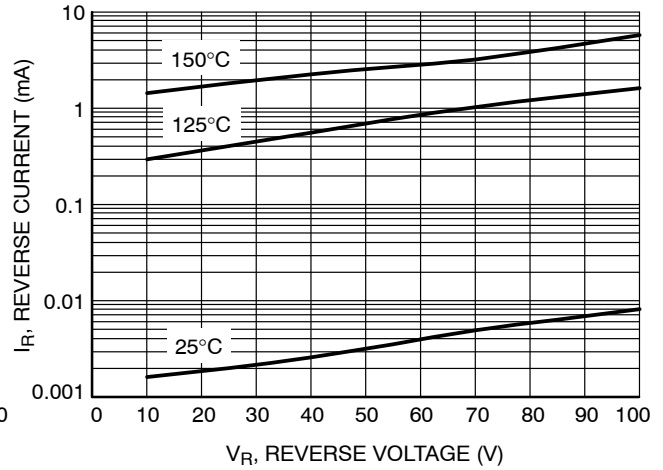

Figure 4. Maximum Reverse Current

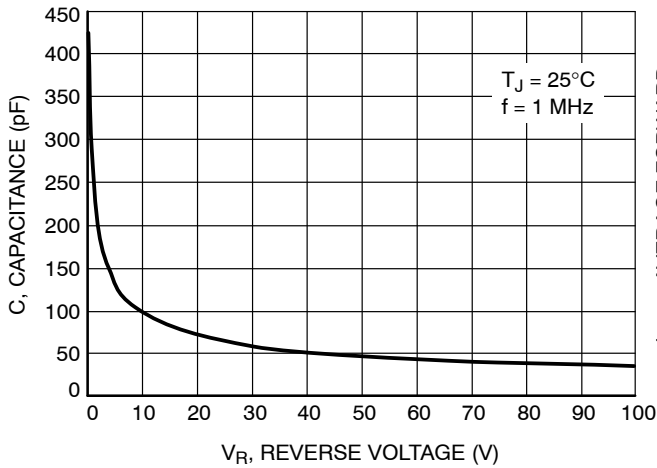

Figure 5. Typical Capacitance

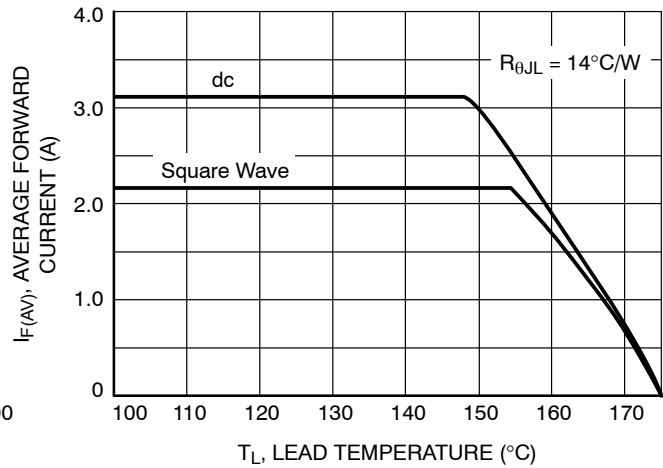

Figure 6. Current Derating – Lead

**MBRS2H100T3G, NBR2H100T3G, NBR2H100NT3G, MBRA2H100T3G,
NRVBA2H100T3G, NRVBA2H100NT3G**

TYPICAL CHARACTERISTICS

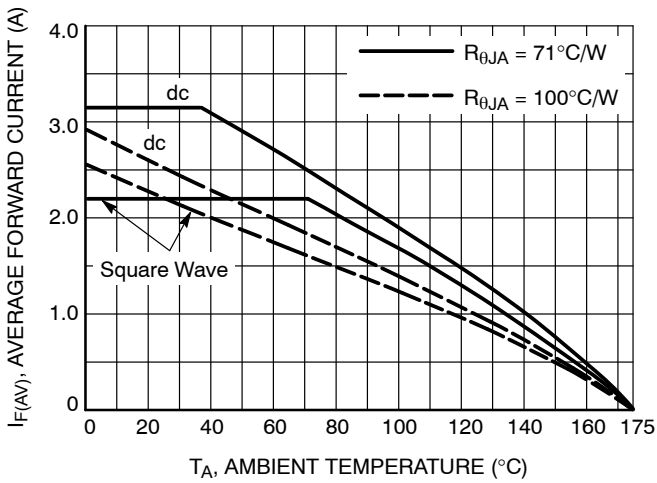

Figure 7. Current Derating, Ambient

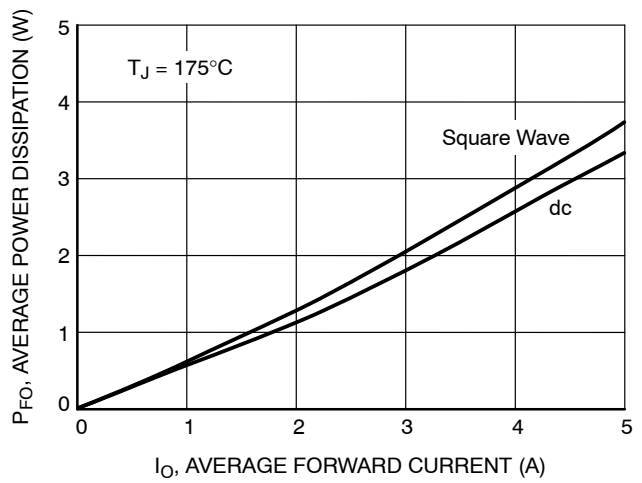
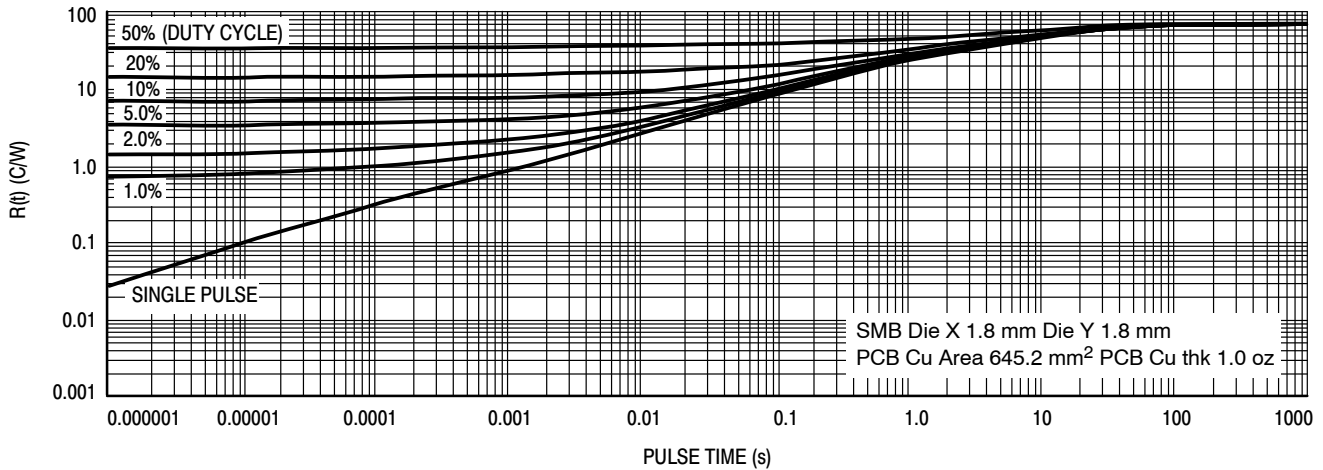
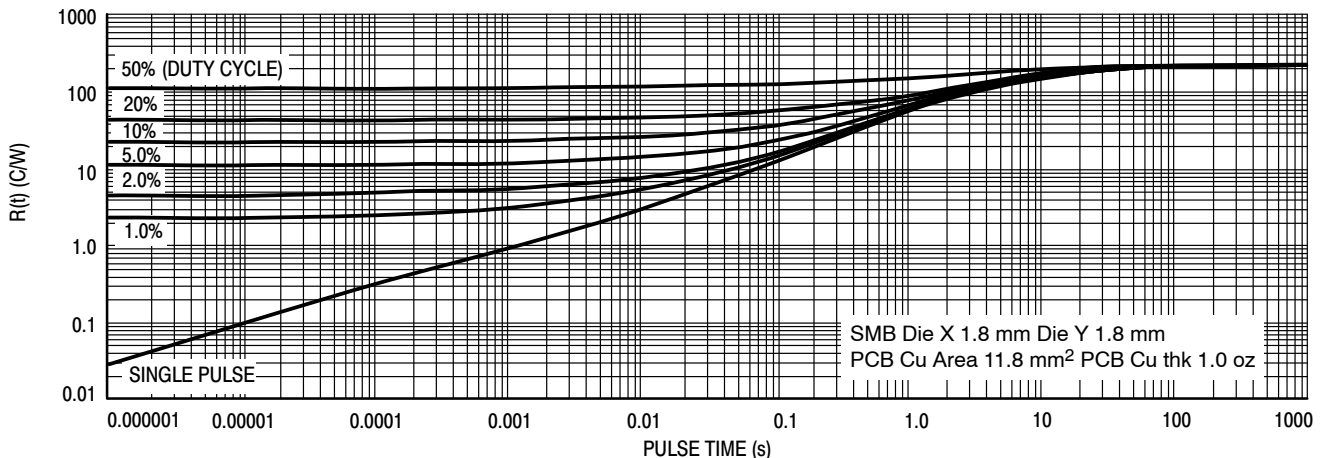

Figure 8. Maximum Forward Power Dissipation



**Figure 9. Thermal Response, Junction-to-Ambient (1 inch pad) –
MBRS2H100T3G/NBR2H100T3G/NBR2H100NT3G**



**Figure 10. Thermal Response, Junction-to-Ambient (min pad) –
MBRS2H100T3G/NBR2H100T3G/NBR2H100NT3G**

**MBRS2H100T3G, NBR2H100T3G, NBR2H100NT3G, MBRA2H100T3G,
NRVBA2H100T3G, NRVBA2H100NT3G**
TYPICAL CHARACTERISTICS

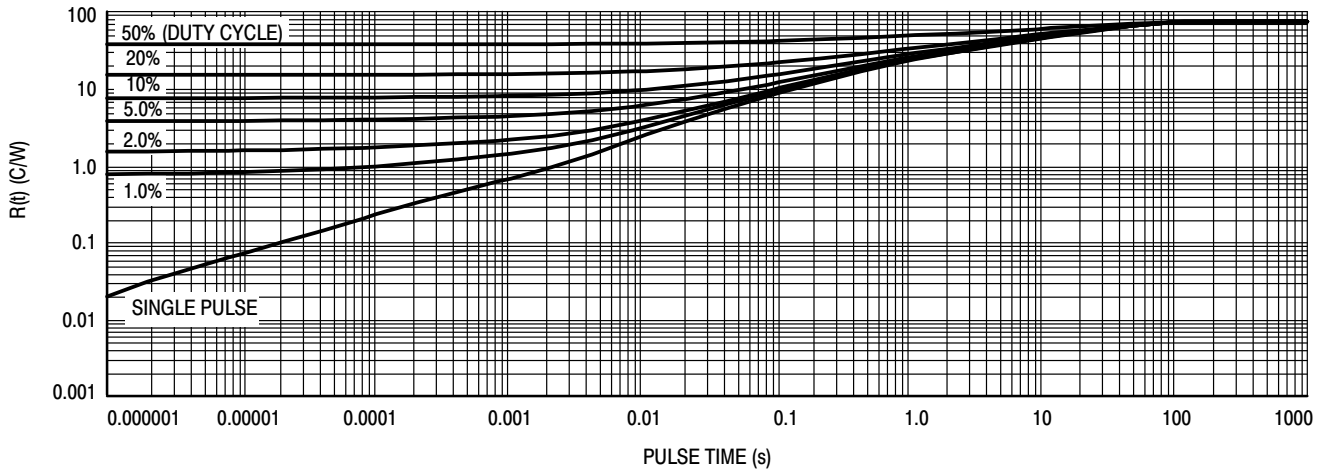

Figure 11. Thermal Response, Junction-to-Ambient (1 inch pad) – MBRA2H100T3G/NRVBA2H100T3G

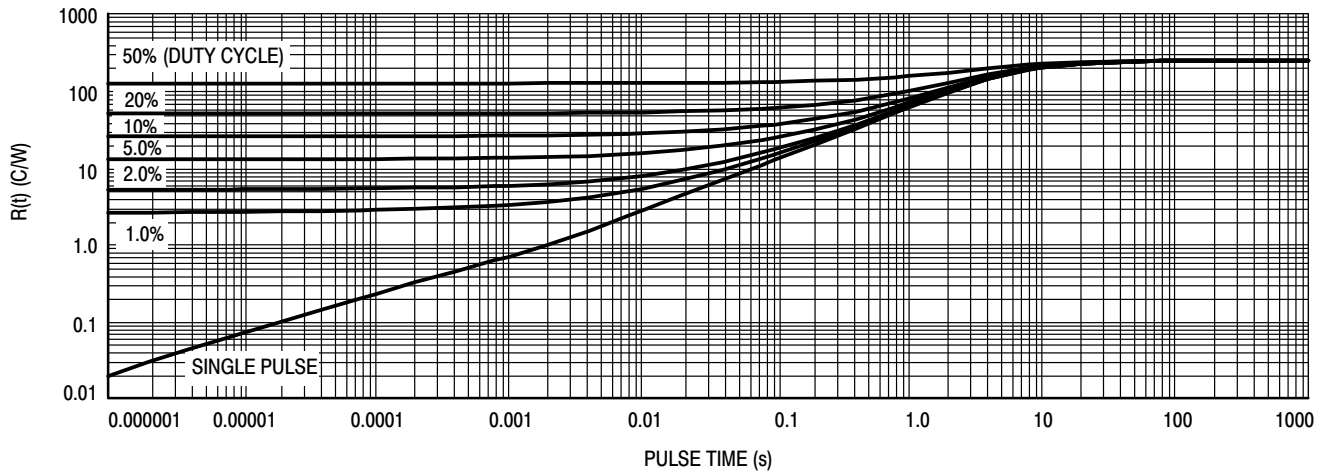

Figure 12. Thermal Response, Junction-to-Ambient (min pad) – MBRA2H100T3G/NRVBA2H100T3G

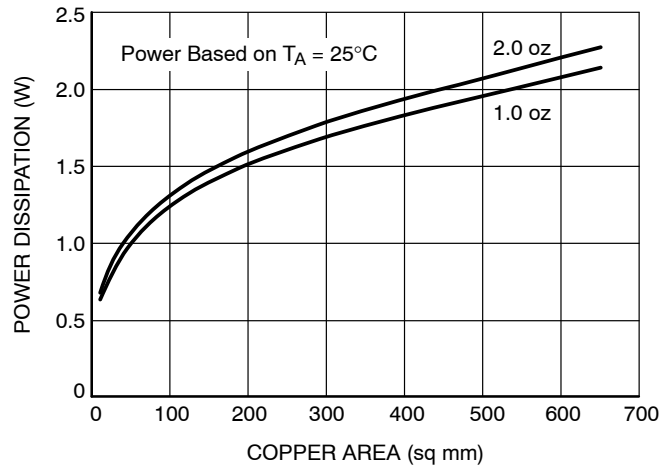

Figure 13. P_D , Junction-to-Ambient (URS copper area)

MECHANICAL CASE OUTLINE

PACKAGE DIMENSIONS

ON Semiconductor®



SCALE 1:1

Polarity Band



SCALE 1:1

Non-Polarity Band

SMB
CASE 403A-03
ISSUE J

DATE 19 JUL 2012

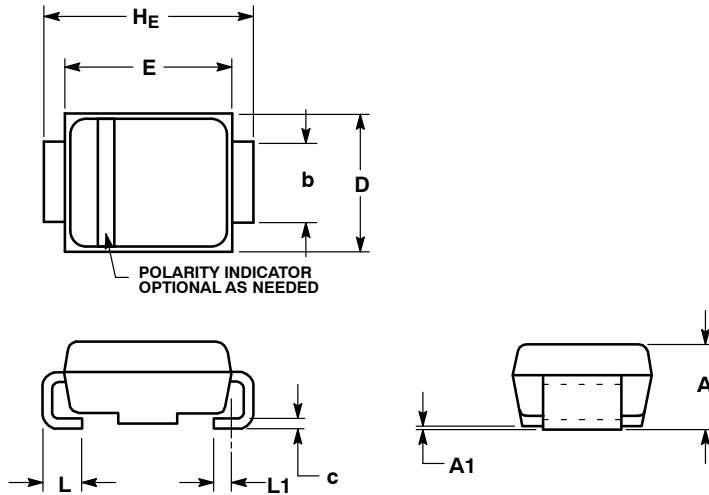

SOLDERING FOOTPRINT*

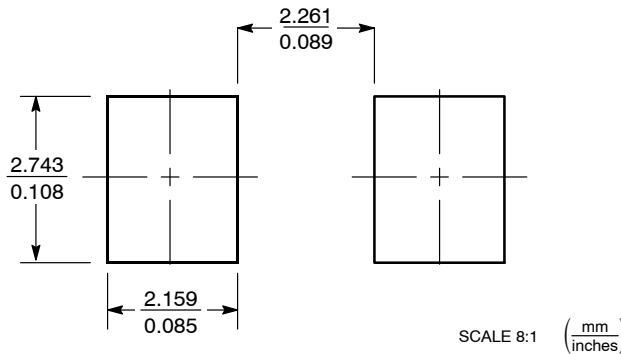

*For additional information on our Pb-Free strategy and soldering details, please download the ON Semiconductor Soldering and Mounting Techniques Reference Manual, SOLDERRM/D.

- NOTES:
1. DIMENSIONING AND TOLERANCING PER ANSI Y14.5M, 1982.
 2. CONTROLLING DIMENSION: INCH.
 3. DIMENSION b SHALL BE MEASURED WITHIN DIMENSION L1.

DIM	MILLIMETERS			INCHES		
	MIN	NOM	MAX	MIN	NOM	MAX
A	1.95	2.30	2.47	0.077	0.091	0.097
A1	0.05	0.10	0.20	0.002	0.004	0.008
b	1.96	2.03	2.20	0.077	0.080	0.087
c	0.15	0.23	0.31	0.006	0.009	0.012
D	3.30	3.56	3.95	0.130	0.140	0.156
E	4.06	4.32	4.60	0.160	0.170	0.181
HE	5.21	5.44	5.60	0.205	0.214	0.220
L	0.76	1.02	1.60	0.030	0.040	0.063
L1	0.51 REF			0.020 REF		

GENERIC MARKING DIAGRAM*

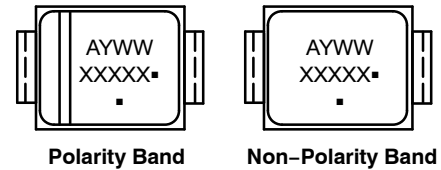

- XXXXX = Specific Device Code
 - A = Assembly Location
 - Y = Year
 - WW = Work Week
 - = Pb-Free Package
- (Note: Microdot may be in either location)

*This information is generic. Please refer to device data sheet for actual part marking. Pb-Free indicator, "G" or microdot "▪", may or may not be present.

DOCUMENT NUMBER:	98ASB42669B	Electronic versions are uncontrolled except when accessed directly from the Document Repository. Printed versions are uncontrolled except when stamped "CONTROLLED COPY" in red.
DESCRIPTION:	SMB	PAGE 1 OF 1

ON Semiconductor and ON are trademarks of Semiconductor Components Industries, LLC dba ON Semiconductor or its subsidiaries in the United States and/or other countries. ON Semiconductor reserves the right to make changes without further notice to any products herein. ON Semiconductor makes no warranty, representation or guarantee regarding the suitability of its products for any particular purpose, nor does ON Semiconductor assume any liability arising out of the application or use of any product or circuit, and specifically disclaims any and all liability, including without limitation special, consequential or incidental damages. ON Semiconductor does not convey any license under its patent rights nor the rights of others.

MECHANICAL CASE OUTLINE PACKAGE DIMENSIONS



STYLE 1 STYLE 2

SCALE 1:1

SMA
CASE 403D
ISSUE J

DATE 22 OCT 2021

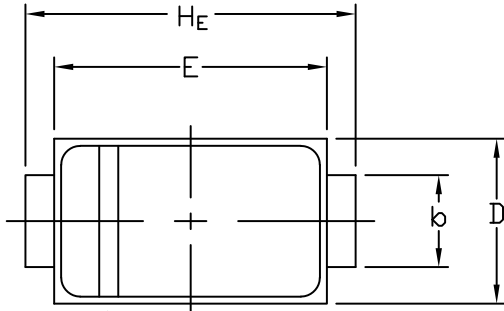

POLARITY INDICATOR
OPTIONAL AS NEEDED

NOTES:

1. DIMENSIONING AND TOLERANCING PER ANSI Y14.5M, 1982.
2. CONTROLLING DIMENSION: INCHES
3. DIMENSION *b* SHALL BE MEASURED WITHIN DIMENSION L.

DIM	MILLIMETERS			INCHES		
	MIN.	NOM.	MAX.	MIN.	NOM.	MAX.
A	1.97	2.10	2.20	0.078	0.083	0.087
A1	0.05	0.10	0.20	0.002	0.004	0.008
<i>b</i>	1.27	1.45	1.63	0.050	0.057	0.064
<i>c</i>	0.15	0.28	0.41	0.006	0.011	0.016
D	2.29	2.60	2.92	0.090	0.103	0.115
E	4.06	4.32	4.57	0.160	0.170	0.180
HE	4.83	5.21	5.59	0.190	0.205	0.220
L	0.76	1.14	1.52	0.030	0.045	0.060

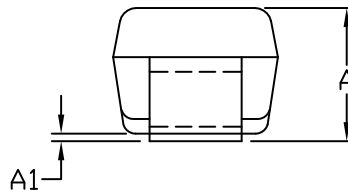
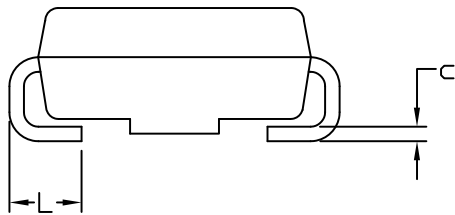

STYLE 1:
PIN 1. CATHODE (POLARITY BAND)
2. ANODE

STYLE 2:
NO POLARITY

**GENERIC
MARKING DIAGRAM***

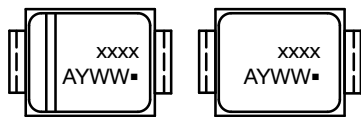

STYLE 1 STYLE 2

- xxxx = Specific Device Code
- A = Assembly Location
- Y = Year
- WW = Work Week
- = Pb-Free Package

*This information is generic. Please refer to device data sheet for actual part marking. Pb-Free indicator, "G" or microdot "▪", may or may not be present. Some products may not follow the Generic Marking.

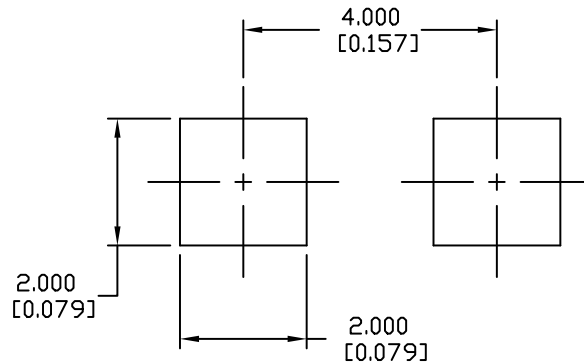

RECOMMENDED
MOUNTING FOOTPRINT

DOCUMENT NUMBER:	98AON04079D	Electronic versions are uncontrolled except when accessed directly from the Document Repository. Printed versions are uncontrolled except when stamped "CONTROLLED COPY" in red.
DESCRIPTION:	SMA	PAGE 1 OF 1

onsemi and ONSEMI are trademarks of Semiconductor Components Industries, LLC dba onsemi or its subsidiaries in the United States and/or other countries. onsemi reserves the right to make changes without further notice to any products herein. onsemi makes no warranty, representation or guarantee regarding the suitability of its products for any particular purpose, nor does onsemi assume any liability arising out of the application or use of any product or circuit, and specifically disclaims any and all liability, including without limitation special, consequential or incidental damages. onsemi does not convey any license under its patent rights nor the rights of others.

onsemi, **Onsemi**, and other names, marks, and brands are registered and/or common law trademarks of Semiconductor Components Industries, LLC dba "**onsemi**" or its affiliates and/or subsidiaries in the United States and/or other countries. **onsemi** owns the rights to a number of patents, trademarks, copyrights, trade secrets, and other intellectual property. A listing of **onsemi**'s product/patent coverage may be accessed at www.onsemi.com/site/pdf/Patent-Marking.pdf. **onsemi** reserves the right to make changes at any time to any products or information herein, without notice. The information herein is provided "as-is" and **onsemi** makes no warranty, representation or guarantee regarding the accuracy of the information, product features, availability, functionality, or suitability of its products for any particular purpose, nor does **onsemi** assume any liability arising out of the application or use of any product or circuit, and specifically disclaims any and all liability, including without limitation special, consequential or incidental damages. Buyer is responsible for its products and applications using **onsemi** products, including compliance with all laws, regulations and safety requirements or standards, regardless of any support or applications information provided by **onsemi**. "Typical" parameters which may be provided in **onsemi** data sheets and/or specifications can and do vary in different applications and actual performance may vary over time. All operating parameters, including "Typicals" must be validated for each customer application by customer's technical experts. **onsemi** does not convey any license under any of its intellectual property rights nor the rights of others. **onsemi** products are not designed, intended, or authorized for use as a critical component in life support systems or any FDA Class 3 medical devices or medical devices with a same or similar classification in a foreign jurisdiction or any devices intended for implantation in the human body. Should Buyer purchase or use **onsemi** products for any such unintended or unauthorized application, Buyer shall indemnify and hold **onsemi** and its officers, employees, subsidiaries, affiliates, and distributors harmless against all claims, costs, damages, and expenses, and reasonable attorney fees arising out of, directly or indirectly, any claim of personal injury or death associated with such unintended or unauthorized use, even if such claim alleges that **onsemi** was negligent regarding the design or manufacture of the part. **onsemi** is an Equal Opportunity/Affirmative Action Employer. This literature is subject to all applicable copyright laws and is not for resale in any manner.

PUBLICATION ORDERING INFORMATION

LITERATURE FULFILLMENT:

Email Requests to: orderlit@onsemi.com

onsemi Website: www.onsemi.com

TECHNICAL SUPPORT

North American Technical Support:
Voice Mail: 1 800-282-9855 Toll Free USA/Canada
Phone: 011 421 33 790 2910

Europe, Middle East and Africa Technical Support:

Phone: 00421 33 790 2910

For additional information, please contact your local Sales Representative

X-ON Electronics

Largest Supplier of Electrical and Electronic Components

Click to view similar products for [Schottky Diodes & Rectifiers](#) category:

Click to view products by [ON Semiconductor](#) manufacturer:

Other Similar products are found below :

[MA4E2039](#) [D1FH3-5063](#) [MBR0530L-TP](#) [MBR10100CT-BP](#) [MBR1545CT](#) [MMBD301M3T5G](#) [RB160M-50TR](#) [RB551V-30](#)
[BAS16E6433HTMA1](#) [BAT 54-02LRH E6327](#) [NSR05F40QNXT5G](#) [NTE555](#) [JANS1N6640](#) [SB07-03C-TB-H](#) [SB1003M3-TL-W](#) [SK310-T](#)
[SK32A-LTP](#) [SK33A-TP](#) [SK34B-TP](#) [SS3003CH-TL-E](#) [GA01SHT18](#) [CRS10I30A\(TE85L,QM](#) [MA4E2501L-1290](#) [MBRB30H30CT-1G](#)
[SB007-03C-TB-E](#) [SK32A-TP](#) [SK33B-TP](#) [SK35A-TP](#) [SK38B-TP](#) [NRVBM120LT1G](#) [NTE505](#) [NTSB30U100CT-1G](#) [SS15E-TP](#) [VS-](#)
[6CWQ10FNHM3](#) [ACDBA1100LR-HF](#) [ACDBA1200-HF](#) [ACDBA140-HF](#) [ACDBA2100-HF](#) [ACDBA3100-HF](#) [CDBQC0530L-HF](#)
[CDBQC0240LR-HF](#) [ACDBA340-HF](#) [ACDBA260LR-HF](#) [ACDBA1100-HF](#) [SK310B-TP](#) [MA4E2502L-1246](#) [MA4E2502H-1246](#)
[NRVBM120ET1G](#) [NSR01L30MXT5G](#) [NTE573](#)