

# NSS30071MR6T1G

## 30 V, 0.7 A, Low $V_{CE(sat)}$ NPN Transistor

ON Semiconductor's e<sup>2</sup>PowerEdge family of low  $V_{CE(sat)}$  transistors are miniature surface mount devices featuring ultra low saturation voltage ( $V_{CE(sat)}$ ) and high current gain capability. These are designed for use in low voltage, high speed switching applications where affordable efficient energy control is important.

Typical application are DC-DC converters and power management in portable and battery powered products such as cellular and cordless phones, PDAs, computers, printers, digital cameras and MP3 players. Other applications are low voltage motor controls in mass storage products such as disc drives and tape drives. In the automotive industry they can be used in air bag deployment and in the instrument cluster. The high current gain allows e<sup>2</sup>PowerEdge devices to be driven directly from PMU's control outputs, and the Linear Gain (Beta) makes them ideal components in analog amplifiers.

- This is a Pb-Free Device

### MAXIMUM RATINGS ( $T_C = 25^\circ\text{C}$ unless otherwise noted)

Rating	Symbol	Value	Unit
Collector-Emitter Voltage	$V_{CEO}$	30	V
Collector-Base Voltage	$V_{CBO}$	40	V
Emitter-Base Voltage	$V_{EBO}$	5.0	V
Collector Current	$I_C$	700	mA
Base Current	$I_B$	350	mA
Total Power Dissipation @ $T_C = 25^\circ\text{C}$	$P_D$	342	mW
Total Power Dissipation @ $T_C = 85^\circ\text{C}$	$P_D$	178	mW
Thermal Resistance - Junction-to-Ambient (Note 1)	$R_{\theta JA}$	366	$^\circ\text{C/W}$
Total Power Dissipation @ $T_C = 25^\circ\text{C}$	$P_D$	665	mW
Total Power Dissipation @ $T_C = 85^\circ\text{C}$	$P_D$	346	mW
Thermal Resistance - Junction-to-Ambient (Note 2)	$R_{\theta JA}$	188	$^\circ\text{C/W}$
Operating and Storage Temperature Range	$T_J, T_{stg}$	-55 to +150	$^\circ\text{C}$

Maximum ratings are those values beyond which device damage can occur. Maximum ratings applied to the device are individual stress limit values (not normal operating conditions) and are not valid simultaneously. If these limits are exceeded, device functional operation is not implied, damage may occur and reliability may be affected.

1. Minimum FR-4 or G-10 PCB, Operating to Steady State.
2. Mounted onto a 2" square FR-4 Board (1" sq 2 oz Cu 0.06" thick single sided), Operating to Steady State.



ON Semiconductor®

<http://onsemi.com>

30 VOLTS

0.7 AMPS

NPN LOW  $V_{CE(sat)}$  TRANSISTOR  
EQUIVALENT  $R_{DS(on)}$  200 m $\Omega$

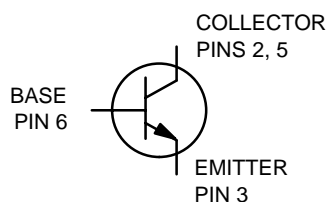

SC-74  
CASE 318F  
STYLE 2

### DEVICE MARKING

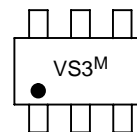

VS3 = Specific Device Code  
M = Date Code

### ORDERING INFORMATION

Device	Package	Shipping†
NSS30071MR6T1G	SC-74 (Pb-Free)	10000/Tape & Reel

†For information on tape and reel specifications, including part orientation and tape sizes, please refer to our Tape and Reel Packaging Specification Brochure. BRD8011/D.

# NSS30071MR6T1G

## ELECTRICAL CHARACTERISTICS (T<sub>C</sub> = 25°C unless otherwise noted)

Symbol	Characteristic	Min	Typ	Max	Unit
<b>OFF CHARACTERISTICS</b>					
V <sub>(BR)CBO</sub>	Collector–Base Breakdown Voltage (I <sub>C</sub> = 100 μAdc)	40	–	–	Vdc
V <sub>(BR)CEO</sub>	Collector–Emitter Breakdown Voltage (I <sub>C</sub> = 10 mAdc)	30	–	–	Vdc
V <sub>(BR)EBO</sub>	Emitter–Base Breakdown Voltage (I <sub>E</sub> = 100 μAdc)	5.0	–	–	Vdc
I <sub>CBO</sub>	Collector Cutoff Current (V <sub>CB</sub> = 25 Vdc, I <sub>E</sub> = 0 Adc) (V <sub>CB</sub> = 25 Vdc, I <sub>E</sub> = 0 Adc, T <sub>A</sub> = 125°C)	–	–	1.0 10	μAdc
I <sub>EBO</sub>	Emitter Cutoff Current (V <sub>EB</sub> = 5.0 Vdc, I <sub>C</sub> = 0 Adc)	–	–	10	μAdc
<b>ON CHARACTERISTICS</b>					
h <sub>FE</sub>	DC Current Gain (V <sub>CE</sub> = 3.0 Vdc, I <sub>C</sub> = 100 mAdc)	150	–	–	Vdc
V <sub>CE(sat)</sub>	Collector–Emitter Saturation Voltage (I <sub>C</sub> = 500 mAdc, I <sub>B</sub> = 50 mAdc)	–	–	0.25	Vdc
V <sub>CE(sat)</sub>	Collector–Emitter Saturation Voltage (I <sub>C</sub> = 700 mAdc, I <sub>B</sub> = 70 mAdc)	–	–	0.4	Vdc
V <sub>BE(sat)</sub>	Base–Emitter Saturation Voltage (I <sub>C</sub> = 700 mAdc, I <sub>B</sub> = 70 mAdc)	–	–	1.1	Vdc
V <sub>BE(on)</sub>	Collector–Emitter Saturation Voltage (I <sub>C</sub> = 700 mAdc, V <sub>CE</sub> = 1.0 Vdc)	–	–	1.0	Vdc

# NSS30071MR6T1G

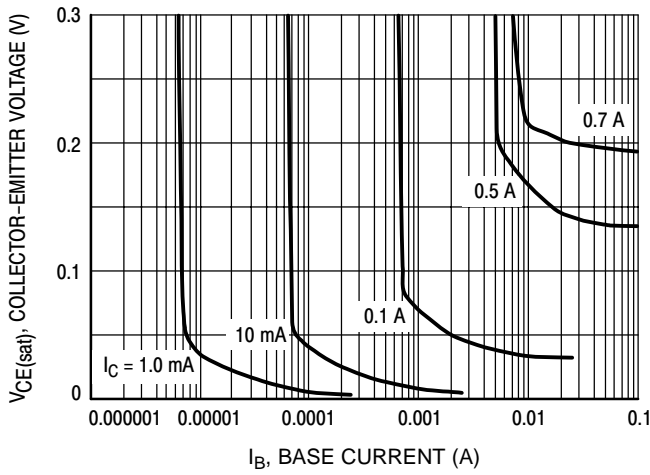

Figure 1. Collector Saturation Region

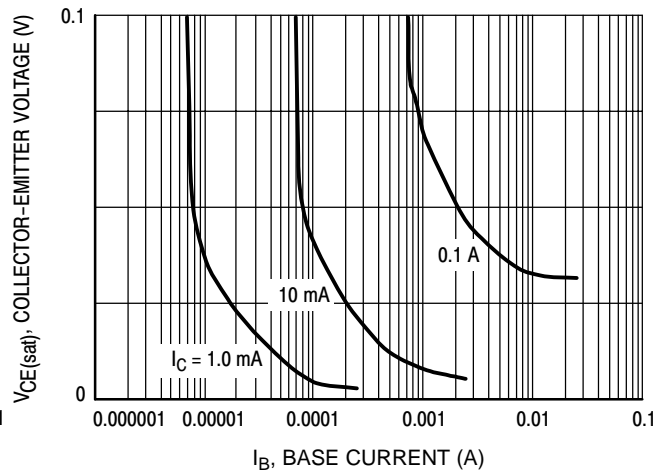

Figure 2. Collector Saturation Region

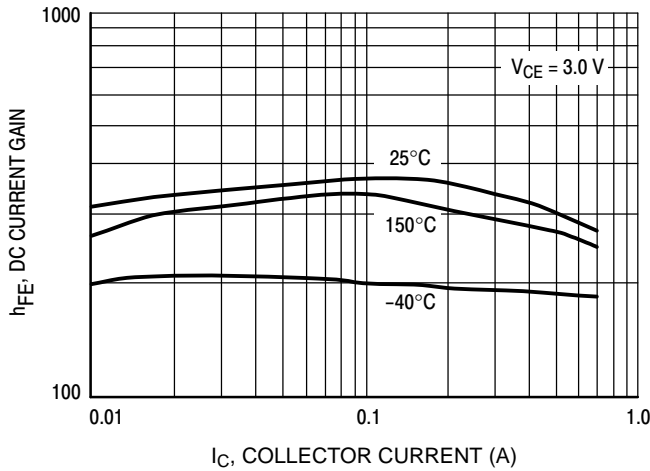

Figure 3. DC Current Gain

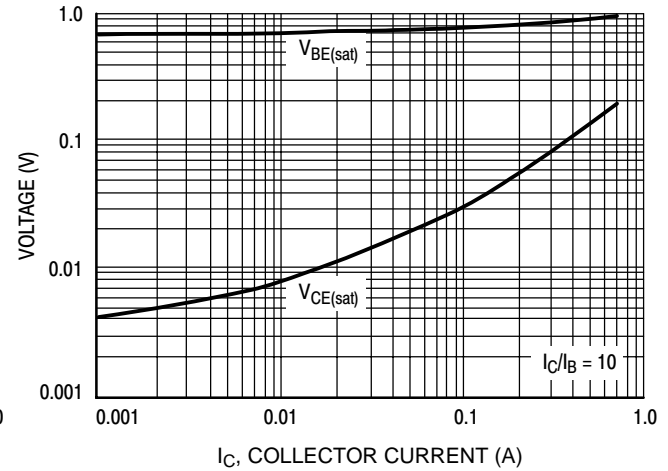

Figure 4. "ON" Voltages

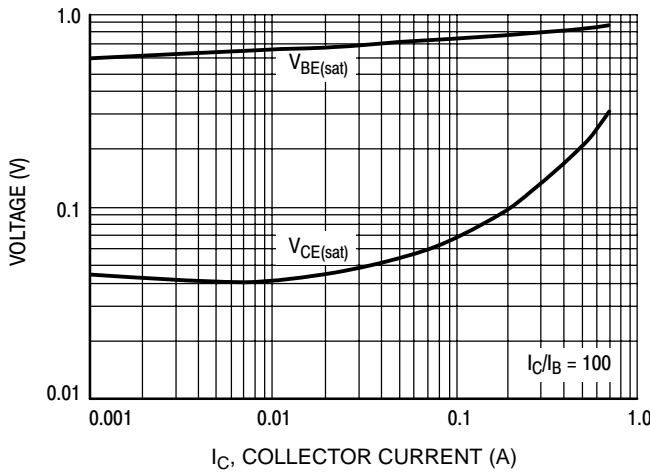

Figure 5. "ON" Voltages

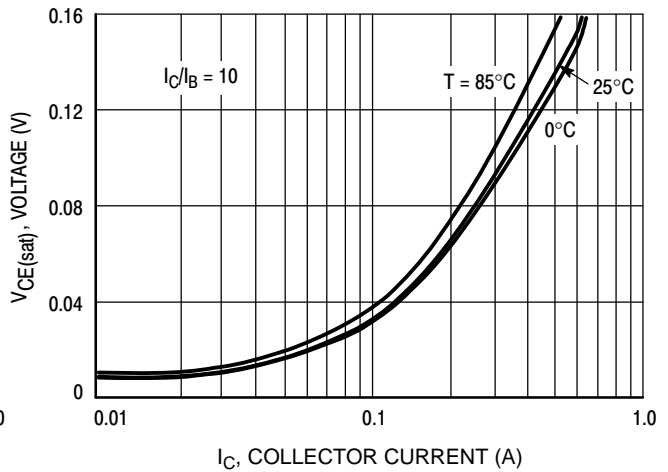

Figure 6. Collector-Emitter Saturation Voltage

# NSS30071MR6T1G

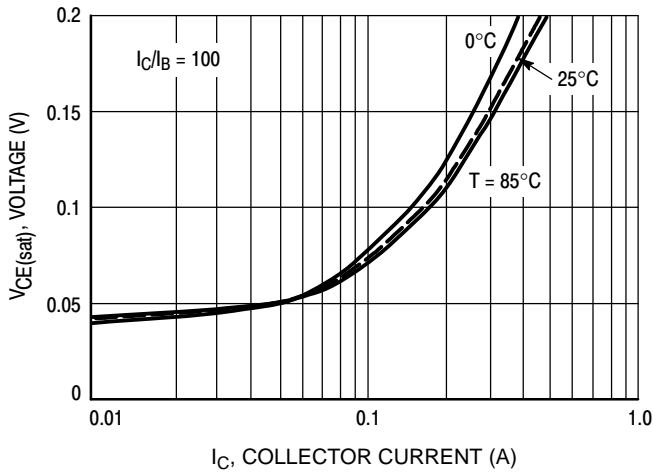

Figure 7. Collector-Emitter Saturation Voltage

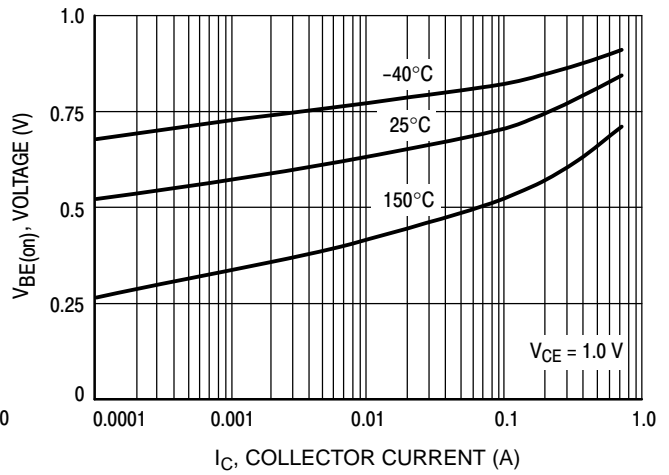

Figure 8.  $V_{BE(on)}$  Voltage

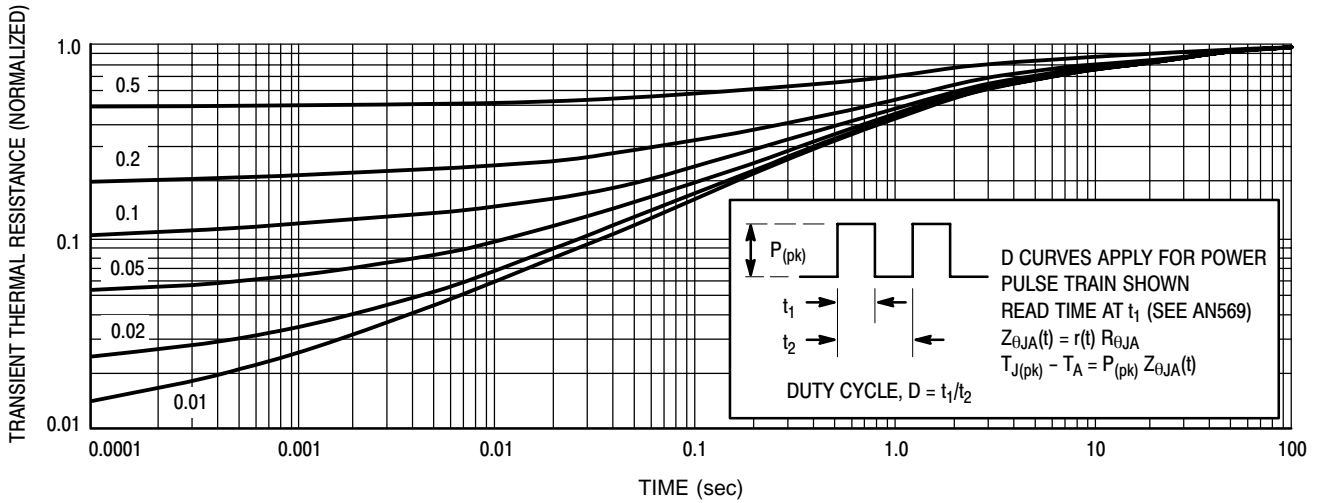

Figure 9. Thermal Response Curve

# MECHANICAL CASE OUTLINE PACKAGE DIMENSIONS



SCALE 2:1

**SC-74**  
CASE 318F  
ISSUE P

DATE 07 OCT 2021

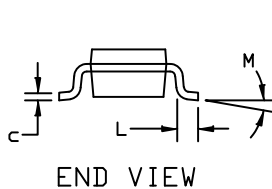
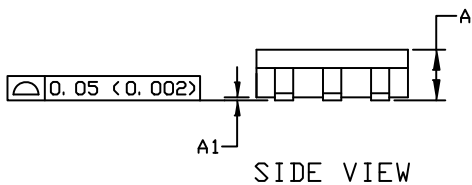
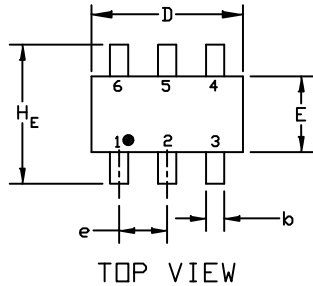

### GENERIC MARKING DIAGRAM\*

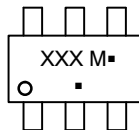

XXX = Specific Device Code  
M = Date Code  
▪ = Pb-Free Package

(Note: Microdot may be in either location)

\*This information is generic. Please refer to device data sheet for actual part marking. Pb-Free indicator, "G" or microdot "▪", may or may not be present. Some products may not follow the Generic Marking.

### NOTES:

1. DIMENSIONING AND TOLERANCING PER ASME Y14.5M, 1994
2. CONTROLLING DIMENSION: INCHES
3. MAXIMUM LEAD THICKNESS INCLUDES LEAD FINISH THICKNESS. MINIMUM LEAD THICKNESS IS THE MINIMUM THICKNESS OF THE BASE MATERIAL.

DIM	MILLIMETERS			INCHES		
	MIN.	NOM.	MAX.	MIN.	NOM.	MAX.
A	0.90	1.00	1.10	0.035	0.039	0.043
A1	0.01	0.06	0.10	0.001	0.002	0.004
b	0.25	0.37	0.50	0.010	0.015	0.020
c	0.10	0.18	0.26	0.004	0.007	0.010
D	2.90	3.00	3.10	0.114	0.118	0.122
E	1.30	1.50	1.70	0.051	0.059	0.067
e	0.85	0.95	1.05	0.034	0.037	0.041
HE	2.50	2.75	3.00	0.099	0.108	0.118
L	0.20	0.40	0.60	0.008	0.016	0.024
M	0*	---	10*	0*	---	10*

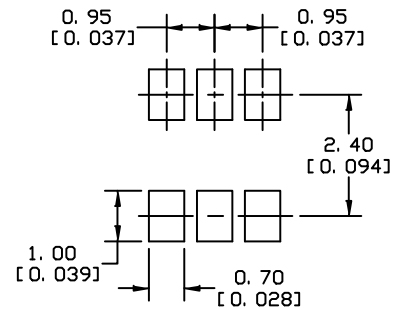

\* For additional information on our Pb-Free strategy and soldering details, please download the DN Semiconductor Soldering and Mounting Techniques Reference Manual, SOLDERM/D.

### SOLDERING FOOTPRINT

- |   |  |   |  |   |   |
|---|--|---|--|---|---|
| <b>STYLE 1:</b><br>PIN 1. CATHODE<br>2. ANODE<br>3. CATHODE<br>4. CATHODE<br>5. ANODE<br>6. CATHODE     | <b>STYLE 2:</b><br>PIN 1. NO CONNECTION<br>2. COLLECTOR<br>3. EMITTER<br>4. NO CONNECTION<br>5. COLLECTOR<br>6. BASE | <b>STYLE 3:</b><br>PIN 1. EMITTER 1<br>2. BASE 1<br>3. COLLECTOR 2<br>4. EMITTER 2<br>5. BASE 2<br>6. COLLECTOR 1 | <b>STYLE 4:</b><br>PIN 1. COLLECTOR 2<br>2. EMITTER 1/EMITTER 2<br>3. COLLECTOR 1<br>4. EMITTER 3<br>5. BASE 1/BASE 2/COLLECTOR 3<br>6. BASE 3 | <b>STYLE 5:</b><br>PIN 1. CHANNEL 1<br>2. ANODE<br>3. CHANNEL 2<br>4. CHANNEL 3<br>5. CATHODE<br>6. CHANNEL 4 | <b>STYLE 6:</b><br>PIN 1. CATHODE<br>2. ANODE<br>3. CATHODE<br>4. CATHODE<br>5. CATHODE<br>6. CATHODE |
| <b>STYLE 7:</b><br>PIN 1. SOURCE 1<br>2. GATE 1<br>3. DRAIN 2<br>4. SOURCE 2<br>5. GATE 2<br>6. DRAIN 1 | <b>STYLE 8:</b><br>PIN 1. EMITTER 1<br>2. BASE 2<br>3. COLLECTOR 2<br>4. EMITTER 2<br>5. BASE 1<br>6. COLLECTOR 1    | <b>STYLE 9:</b><br>PIN 1. EMITTER 2<br>2. BASE 2<br>3. COLLECTOR 1<br>4. EMITTER 1<br>5. BASE 1<br>6. COLLECTOR 2 | <b>STYLE 10:</b><br>PIN 1. ANODE/CATHODE<br>2. BASE<br>3. EMITTER<br>4. COLLECTOR<br>5. ANODE<br>6. CATHODE                                    | <b>STYLE 11:</b><br>PIN 1. EMITTER<br>2. BASE<br>3. ANODE/CATHODE<br>4. ANODE<br>5. CATHODE<br>6. COLLECTOR   |   |

<b>DOCUMENT NUMBER:</b>	<b>98ASB42973B</b>	Electronic versions are uncontrolled except when accessed directly from the Document Repository. Printed versions are uncontrolled except when stamped "CONTROLLED COPY" in red.
<b>DESCRIPTION:</b>	<b>SC-74</b>	<b>PAGE 1 OF 1</b>

onsemi and ONSEMI are trademarks of Semiconductor Components Industries, LLC dba onsemi or its subsidiaries in the United States and/or other countries. onsemi reserves the right to make changes without further notice to any products herein. onsemi makes no warranty, representation or guarantee regarding the suitability of its products for any particular purpose, nor does onsemi assume any liability arising out of the application or use of any product or circuit, and specifically disclaims any and all liability, including without limitation special, consequential or incidental damages. onsemi does not convey any license under its patent rights nor the rights of others.

**onsemi**, **Onsemi**, and other names, marks, and brands are registered and/or common law trademarks of Semiconductor Components Industries, LLC dba "**onsemi**" or its affiliates and/or subsidiaries in the United States and/or other countries. **onsemi** owns the rights to a number of patents, trademarks, copyrights, trade secrets, and other intellectual property. A listing of **onsemi**'s product/patent coverage may be accessed at [www.onsemi.com/site/pdf/Patent-Marking.pdf](http://www.onsemi.com/site/pdf/Patent-Marking.pdf). **onsemi** reserves the right to make changes at any time to any products or information herein, without notice. The information herein is provided "as-is" and **onsemi** makes no warranty, representation or guarantee regarding the accuracy of the information, product features, availability, functionality, or suitability of its products for any particular purpose, nor does **onsemi** assume any liability arising out of the application or use of any product or circuit, and specifically disclaims any and all liability, including without limitation special, consequential or incidental damages. Buyer is responsible for its products and applications using **onsemi** products, including compliance with all laws, regulations and safety requirements or standards, regardless of any support or applications information provided by **onsemi**. "Typical" parameters which may be provided in **onsemi** data sheets and/or specifications can and do vary in different applications and actual performance may vary over time. All operating parameters, including "Typicals" must be validated for each customer application by customer's technical experts. **onsemi** does not convey any license under any of its intellectual property rights nor the rights of others. **onsemi** products are not designed, intended, or authorized for use as a critical component in life support systems or any FDA Class 3 medical devices or medical devices with a same or similar classification in a foreign jurisdiction or any devices intended for implantation in the human body. Should Buyer purchase or use **onsemi** products for any such unintended or unauthorized application, Buyer shall indemnify and hold **onsemi** and its officers, employees, subsidiaries, affiliates, and distributors harmless against all claims, costs, damages, and expenses, and reasonable attorney fees arising out of, directly or indirectly, any claim of personal injury or death associated with such unintended or unauthorized use, even if such claim alleges that **onsemi** was negligent regarding the design or manufacture of the part. **onsemi** is an Equal Opportunity/Affirmative Action Employer. This literature is subject to all applicable copyright laws and is not for resale in any manner.

## PUBLICATION ORDERING INFORMATION

### LITERATURE FULFILLMENT:

Email Requests to: [orderlit@onsemi.com](mailto:orderlit@onsemi.com)

**onsemi Website:** [www.onsemi.com](http://www.onsemi.com)

### TECHNICAL SUPPORT

**North American Technical Support:**  
Voice Mail: 1 800-282-9855 Toll Free USA/Canada  
Phone: 011 421 33 790 2910

**Europe, Middle East and Africa Technical Support:**

Phone: 00421 33 790 2910

For additional information, please contact your local Sales Representative

## X-ON Electronics

Largest Supplier of Electrical and Electronic Components

*Click to view similar products for [Bipolar Transistors - BJT category](#):*

*Click to view products by [ON Semiconductor manufacturer](#):*

Other Similar products are found below :

[619691C](#) [MCH4017-TL-H](#) [BC546/116](#) [BC557/116](#) [BSW67A](#) [NTE158](#) [NTE187A](#) [NTE195A](#) [NTE2302](#) [NTE2330](#) [NTE63](#) [C4460](#)  
[2SA1419T-TD-H](#) [2SA1721-O\(TE85L,F\)](#) [2SA2126-E](#) [2SB1204S-TL-E](#) [2SC5488A-TL-H](#) [2SD2150T100R](#) [SP000011176](#) [FMMTA92QTA](#)  
[2N2369ADCSM](#) [2SC2412KT146S](#) [2SC5490A-TL-H](#) [2SD1816S-TL-E](#) [2SD1816T-TL-E](#) [CMXT2207 TR](#) [CPH6501-TL-E](#) [MCH4021-TL-E](#)  
[US6T6TR](#) [732314D](#) [CMXT3906 TR](#) [CPH3121-TL-E](#) [CPH6021-TL-H](#) [873787E](#) [IMZ2AT108](#) [UMX21NTR](#) [EMT2T2R](#) [MCH6102-TL-E](#)  
[FP204-TL-E](#) [NJL0302DG](#) [2N3583](#) [2SA1434-TB-E](#) [2SC3143-4-TB-E](#) [2SD1621S-TD-E](#) [NTE103](#) [30A02MH-TL-E](#) [NSV40301MZ4T1G](#)  
[NTE101](#) [NTE13](#) [NTE15](#)