

ON Semiconductor

Is Now

onsemi™

To learn more about onsemi™, please visit our website at
www.onsemi.com

onsemi and **onsemi** and other names, marks, and brands are registered and/or common law trademarks of Semiconductor Components Industries, LLC dba "**onsemi**" or its affiliates and/or subsidiaries in the United States and/or other countries. **onsemi** owns the rights to a number of patents, trademarks, copyrights, trade secrets, and other intellectual property. A listing of **onsemi** product/patent coverage may be accessed at www.onsemi.com/site/pdf/Patent-Marking.pdf. **onsemi** reserves the right to make changes at any time to any products or information herein, without notice. The information herein is provided "as-is" and **onsemi** makes no warranty, representation or guarantee regarding the accuracy of the information, product features, availability, functionality, or suitability of its products for any particular purpose, nor does **onsemi** assume any liability arising out of the application or use of any product or circuit, and specifically disclaims any and all liability, including without limitation special, consequential or incidental damages. Buyer is responsible for its products and applications using **onsemi** products, including compliance with all laws, regulations and safety requirements or standards, regardless of any support or applications information provided by **onsemi**. "Typical" parameters which may be provided in **onsemi** data sheets and/or specifications can and do vary in different applications and actual performance may vary over time. All operating parameters, including "Typicals" must be validated for each customer application by customer's technical experts. **onsemi** does not convey any license under any of its intellectual property rights nor the rights of others. **onsemi** products are not designed, intended, or authorized for use as a critical component in life support systems or any FDA Class 3 medical devices or medical devices with a same or similar classification in a foreign jurisdiction or any devices intended for implantation in the human body. Should Buyer purchase or use **onsemi** products for any such unintended or unauthorized application, Buyer shall indemnify and hold **onsemi** and its officers, employees, subsidiaries, affiliates, and distributors harmless against all claims, costs, damages, and expenses, and reasonable attorney fees arising out of, directly or indirectly, any claim of personal injury or death associated with such unintended or unauthorized use, even if such claim alleges that **onsemi** was negligent regarding the design or manufacture of the part. **onsemi** is an Equal Opportunity/Affirmative Action Employer. This literature is subject to all applicable copyright laws and is not for resale in any manner. Other names and brands may be claimed as the property of others.

NSVF4020SG4

RF Transistor for Low Noise Amplifier



ON Semiconductor®

www.onsemi.com

This RF transistor is designed for low noise amplifier applications. MCPH package is suitable for use under high temperature environment because it has superior heat radiation characteristics. This RF transistor is AEC-Q101 qualified and PPAP capable for automotive applications.

Features

- Low-noise use : $NF = 1.2 \text{ dB typ. (} f = 1 \text{ GHz)}$
- High cut-off frequency : $f_T = 16 \text{ GHz typ. (} V_{CE} = 5 \text{ V)}$
- High gain : $|S_{21e}|^2 = 17.5 \text{ dB typ. (} f = 1 \text{ GHz)}$
- AEC-Q101 qualified and PPAP capable
- MCPH4 package is pin-compatible with SC-82FL
- Pb-Free, Halogen Free and RoHS compliance

Typical Applications

- Low Noise Amplifier for Satellite Radio
- Low Noise Amplifier for TV

SPECIFICATIONS

ABSOLUTE MAXIMUM RATING at $T_a = 25^\circ\text{C}$ (Note 1)

Parameter	Symbol	Value	Unit
Collector to Base Voltage	V_{CBO}	15	V
Collector to Emitter Voltage	V_{CEO}	8	V
Emitter to Base Voltage	V_{EBO}	2	V
Collector Current	I_C	150	mA
Collector Dissipation	P_C	400	mW
Operating Junction and Storage Temperature	T_j, T_{stg}	-55 to +150	$^\circ\text{C}$

Note 1 : Stresses exceeding those listed in the Maximum Ratings table may damage the device. If any of these limits are exceeded, device functionality should not be assumed, damage may occur and reliability may be affected.

8 V, 150 mA
 $f_T = 16 \text{ GHz typ.}$
RF Transistor

ELECTRICAL CONNECTION NPN

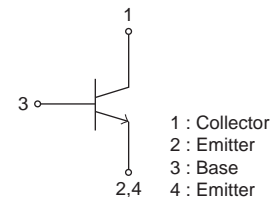

MARKING



ORDERING INFORMATION

See detailed ordering and shipping information on page 10 of this data sheet.

ELECTRICAL CHARACTERISTICS at Ta = 25°C (Note 2)

Parameter	Symbol	Conditions	Value			Unit
			min	typ	max	
Collector Cutoff Current	ICBO	V _{CB} = 5 V, I _E = 0 A			1.0	μA
Emitter Cutoff Current	IEBO	V _{EB} = 1 V, I _C = 0 A			1.0	μA
DC Current Gain	h _{FE}	V _{CE} = 5 V, I _C = 50 mA	60		150	
Gain-Bandwidth Product	f _T	V _{CE} = 5 V, I _C = 50 mA	13	16		GHz
Forward Transfer Gain	S _{21e} ²	V _{CE} = 5 V, I _C = 50 mA, f = 1 GHz		17.5		dB
Noise Figure	NF	V _{CE} = 1 V, I _C = 10 mA, f = 1 GHz		1.2	1.8	dB

Note 2 : Product parametric performance is indicated in the Electrical Characteristics for the listed test conditions, unless otherwise noted. Product performance may not be indicated by the Electrical Characteristics if operated under different conditions.

Note 3 : Pay attention to handling since it is liable to be affected by static electricity due to the high-frequency process adopted.

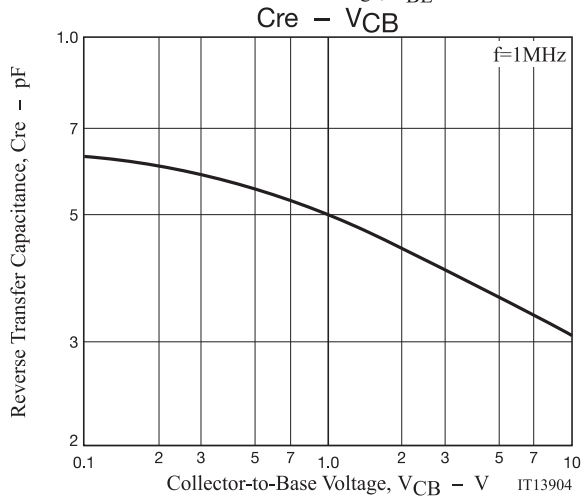
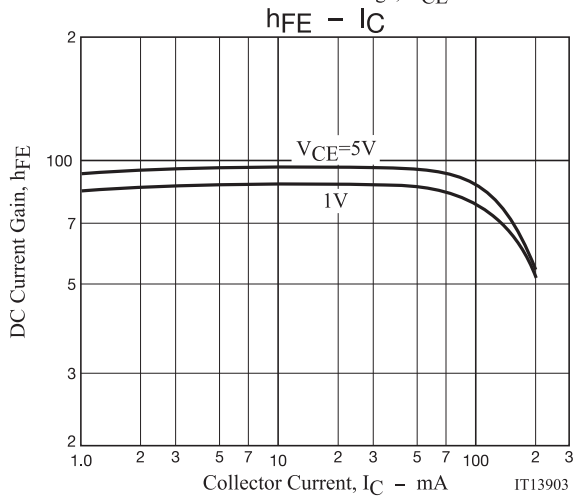
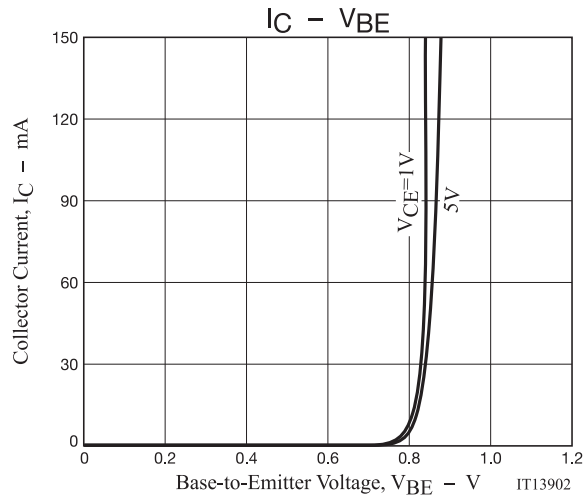
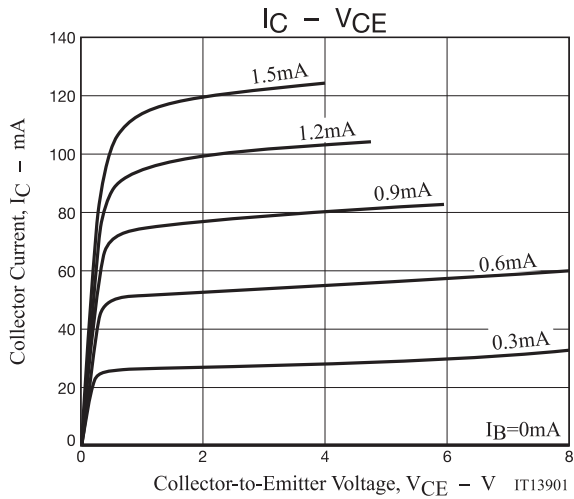

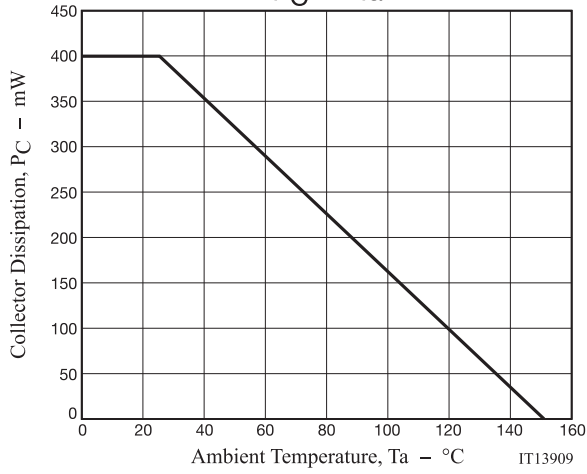
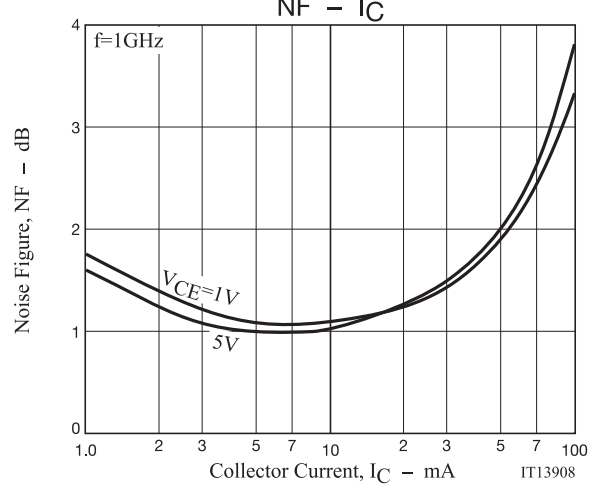
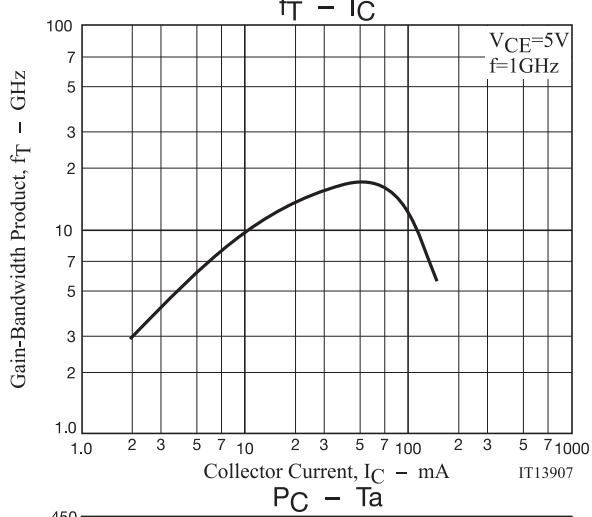
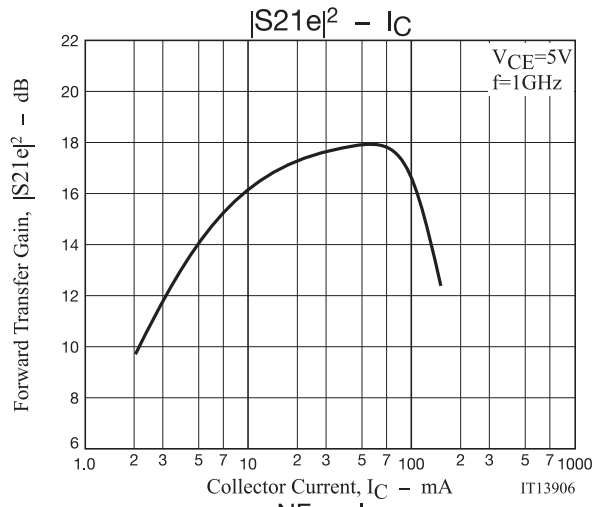
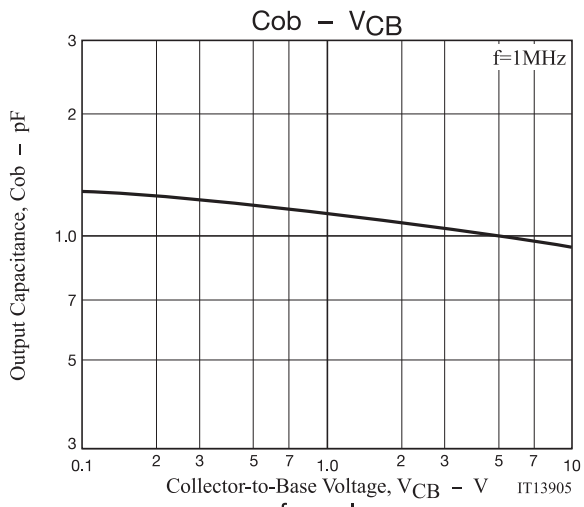

SPICE Parameters

model: Gummel-Poon

Parameter	Value	Unit	Parameter	Value	Unit
IS	2.155f	A	TF	6.700p	S
BF	122		XTF	50.00f	
NF	1.05		VTF	750.0m	V
VAF	8	V	ITF	50	A
IKF	206.4m	A	PTF	200.0m	°C
ISE	1.384p	A	CJC	175.0f	F
NE	2.278		VJC	200.0f	V
BR	14		MJC	1.150p	
NR	1.042		XCJC	1	
VAR	4	V	TR	0	S
IKR	360.0m	A	FC	500.0m	
ISC	140.0f	A	CJS	550.0f	F
NC	1.6		VJS	150.0m	V
RB	2	Ω	MJS	136.0m	
IRB	1.5	A	Lfc	110.0p	H
RBM	25.00m	Ω	Lwb	850.0p	H
RE	450.0m	Ω	Lfb	73.0p	H
RC	1.2	Ω	Lwe	145.0p	H
XTB	0		Lfe	280.0p	H
EG	1.11	eV	Cbc	325.0f	F
XTI	1		Ceb	175.0f	F
CJE	2.476p	F	Cce	120.0f	F
VJE	750.0m	V			
MJE	10.00m				

Schematic

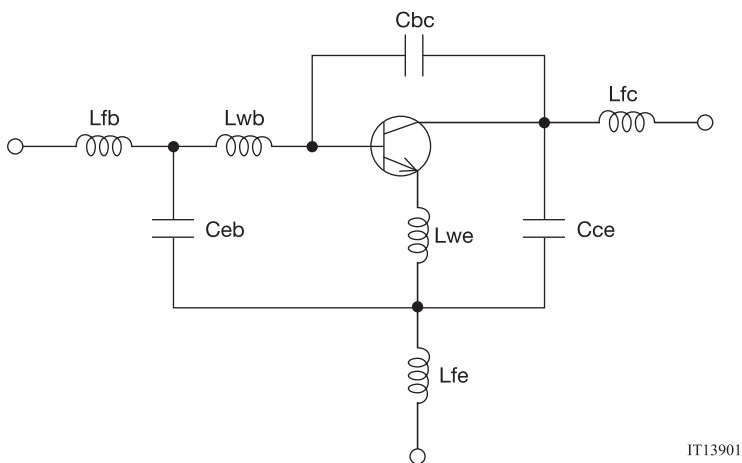

IT13901

*Information (including circuit diagrams and circuit parameters) herein is for example only ; it is not guaranteed for volume production.

S Parameters (Common emitter)V_{CE}=1V, I_C=10mA

Freq(MHz)	S11	∠S11	S21	∠S21	S12	∠S12	S22	∠S22
200	0.664	-88.0	17.728	131.6	0.046	52.6	0.753	-60.7
400	0.674	-130.4	11.682	107.8	0.061	40.5	0.567	-93.8
600	0.681	-147.2	8.523	95.7	0.071	38.0	0.513	-106.8
800	0.666	-160.0	6.411	87.9	0.076	38.4	0.445	-118.0
1000	0.658	-168.7	5.131	82.2	0.082	39.7	0.414	-126.1
1200	0.657	-175.3	4.280	77.4	0.087	41.3	0.393	-132.2
1400	0.657	179.2	3.679	73.1	0.093	42.8	0.382	-136.8
1600	0.657	174.3	3.228	69.2	0.100	44.4	0.375	-141.0
1800	0.658	170.2	2.878	65.5	0.107	45.5	0.372	-143.9
2000	0.659	166.6	2.608	62.0	0.114	46.5	0.372	-146.8
2200	0.657	162.8	2.379	58.7	0.122	47.2	0.374	-149.0
2400	0.658	159.4	2.193	55.3	0.130	47.6	0.378	-151.2
2600	0.657	156.0	2.041	52.2	0.138	47.8	0.384	-153.4
2800	0.657	152.7	1.909	49.0	0.146	47.9	0.390	-154.6
3000	0.655	149.4	1.793	46.0	0.155	47.8	0.399	-156.0
3200	0.652	146.0	1.693	42.9	0.163	47.5	0.409	-157.2
3400	0.652	142.6	1.605	39.9	0.172	47.1	0.419	-158.1
3600	0.651	139.0	1.528	37.1	0.180	46.6	0.432	-158.9
3800	0.650	135.6	1.456	34.2	0.189	45.8	0.443	-159.6
4000	0.650	131.8	1.393	31.3	0.198	45.0	0.455	-160.2
4200	0.650	128.2	1.337	28.6	0.206	44.2	0.467	-160.8
4400	0.652	124.6	1.281	26.0	0.215	43.3	0.479	-161.2
4600	0.653	120.8	1.233	23.5	0.224	42.2	0.489	-161.5
4800	0.654	117.3	1.185	20.8	0.232	41.1	0.499	-161.7
5000	0.656	113.8	1.147	18.4	0.240	40.0	0.508	-162.1

V_{CE}=1V, I_C=50mA

Freq(MHz)	S11	∠S11	S21	∠S21	S12	∠S12	S22	∠S22
200	0.652	-152.6	22.719	111.2	0.024	50.4	0.545	-102.4
400	0.694	-168.0	12.745	95.1	0.034	54.6	0.466	-133.3
600	0.693	-174.1	8.865	86.6	0.045	58.6	0.442	-140.7
800	0.694	179.3	6.618	81.7	0.055	61.5	0.422	-149.5
1000	0.693	174.3	5.279	77.7	0.066	63.1	0.415	-154.8
1200	0.697	170.1	4.399	74.2	0.078	64.0	0.410	-159.2
1400	0.698	166.3	3.771	70.8	0.089	64.0	0.407	-162.2
1600	0.700	162.8	3.307	67.7	0.100	63.8	0.405	-165.0
1800	0.700	159.6	2.961	64.7	0.111	63.3	0.403	-167.1
2000	0.700	156.8	2.683	61.8	0.122	62.7	0.405	-169.1
2200	0.699	153.5	2.457	59.0	0.134	61.8	0.407	-170.8
2400	0.699	150.5	2.260	56.0	0.145	60.6	0.410	-172.2
2600	0.696	147.6	2.105	53.2	0.156	59.4	0.413	-173.6
2800	0.696	144.6	1.976	50.5	0.167	58.2	0.416	-174.4
3000	0.692	141.5	1.861	47.8	0.177	56.8	0.422	-175.4
3200	0.688	138.3	1.761	45.0	0.188	55.4	0.429	-175.9
3400	0.687	135.0	1.674	42.3	0.198	53.8	0.433	-176.3
3600	0.684	131.6	1.598	39.7	0.209	52.4	0.441	-176.5
3800	0.681	128.3	1.526	37.0	0.219	50.8	0.448	-176.6
4000	0.680	124.7	1.462	34.3	0.229	49.2	0.456	-176.6
4200	0.679	121.2	1.403	31.7	0.239	47.5	0.463	-176.6
4400	0.678	117.7	1.351	29.3	0.248	46.0	0.470	-176.4
4600	0.678	114.1	1.305	26.8	0.257	44.3	0.476	-176.2
4800	0.676	110.7	1.260	24.3	0.266	42.5	0.480	-176.1
5000	0.676	107.4	1.224	22.0	0.274	40.9	0.485	-176.0

S Parameters (Common emitter)

V_{CE}=1V, I_C=100mA

Freq(MHz)	S11	∠S11	S21	∠S21	S12	∠S12	S22	∠S22
200	0.797	-170.2	11.994	103.3	0.023	46.0	0.462	-142.7
400	0.821	-178.6	6.267	90.3	0.032	55.8	0.471	-159.7
600	0.814	176.9	4.334	82.5	0.044	60.5	0.456	-162.5
800	0.816	172.4	3.254	78.0	0.056	63.5	0.453	-167.1
1000	0.815	168.6	2.616	73.9	0.068	65.0	0.452	-169.7
1200	0.819	165.2	2.196	70.2	0.080	65.6	0.452	-172.2
1400	0.819	162.0	1.895	66.7	0.092	65.4	0.452	-173.8
1600	0.821	158.9	1.674	63.1	0.104	64.8	0.453	-175.5
1800	0.821	155.9	1.516	59.9	0.116	64.3	0.451	-177.0
2000	0.821	153.3	1.378	56.8	0.128	63.4	0.455	-178.3
2200	0.819	150.2	1.270	53.8	0.140	62.4	0.458	-179.4
2400	0.818	147.4	1.178	50.7	0.152	61.1	0.462	179.5
2600	0.815	144.6	1.107	47.7	0.164	59.7	0.464	178.3
2800	0.814	141.6	1.048	44.9	0.176	58.3	0.469	177.7
3000	0.809	138.5	0.995	42.2	0.187	56.9	0.475	176.9
3200	0.805	135.5	0.949	39.4	0.198	55.3	0.481	176.5
3400	0.803	132.2	0.909	36.7	0.209	53.8	0.486	176.1
3600	0.799	128.9	0.875	34.2	0.221	52.2	0.493	175.9
3800	0.796	125.6	0.842	31.6	0.232	50.5	0.499	175.7
4000	0.794	122.1	0.812	29.1	0.242	48.7	0.505	175.6
4200	0.792	118.7	0.785	26.7	0.252	47.0	0.511	175.6
4400	0.790	115.3	0.762	24.5	0.262	45.3	0.516	175.7
4600	0.788	111.8	0.743	22.3	0.272	43.4	0.519	175.8
4800	0.787	108.3	0.722	20.0	0.281	41.6	0.522	175.8
5000	0.785	105.1	0.707	17.9	0.290	39.9	0.525	175.8

V_{CE}=3V, I_C=10mA

Freq(MHz)	S11	∠S11	S21	∠S21	S12	∠S12	S22	∠S22
200	0.667	-73.4	19.421	137.2	0.036	59.5	0.807	-46.2
400	0.654	-117.7	13.670	112.4	0.051	46.8	0.610	-74.6
600	0.657	-137.3	10.173	99.3	0.060	43.7	0.541	-86.7
800	0.635	-152.0	7.684	90.5	0.066	43.4	0.452	-96.5
1000	0.624	-162.0	6.158	84.2	0.071	44.2	0.407	-104.3
1200	0.621	-169.6	5.138	79.1	0.076	45.7	0.376	-110.1
1400	0.620	-175.7	4.400	74.5	0.082	47.0	0.360	-114.7
1600	0.619	178.9	3.867	70.4	0.088	48.7	0.347	-119.0
1800	0.620	174.4	3.431	66.7	0.095	49.8	0.343	-122.2
2000	0.621	170.6	3.103	63.0	0.101	50.9	0.341	-125.5
2200	0.620	166.6	2.828	59.5	0.108	51.7	0.343	-128.1
2400	0.621	163.0	2.602	56.1	0.116	52.3	0.347	-130.7
2600	0.620	159.4	2.419	52.9	0.124	52.6	0.353	-133.3
2800	0.622	156.1	2.253	49.6	0.131	52.8	0.361	-135.1
3000	0.620	152.7	2.112	46.5	0.139	52.8	0.372	-137.1
3200	0.618	149.2	1.990	43.3	0.148	52.6	0.384	-138.9
3400	0.619	145.6	1.881	40.3	0.156	52.3	0.396	-140.4
3600	0.618	142.1	1.784	37.3	0.164	51.9	0.412	-141.7
3800	0.618	138.5	1.696	34.3	0.173	51.2	0.426	-143.0
4000	0.618	134.7	1.618	31.4	0.182	50.5	0.441	-144.1
4200	0.620	130.9	1.549	28.6	0.191	49.6	0.456	-145.3
4400	0.621	127.2	1.480	25.9	0.199	48.7	0.471	-146.2
4600	0.623	123.4	1.419	23.2	0.208	47.7	0.485	-147.0
4800	0.626	119.8	1.359	20.5	0.216	46.7	0.498	-147.7
5000	0.629	116.2	1.309	18.0	0.224	45.6	0.511	-148.5

S Parameters (Common emitter)V_{CE}=3V, I_C=50mA

Freq(MHz)	S11	∠S11	S21	∠S21	S12	∠S12	S22	∠S22
200	0.516	-135.8	31.907	119.4	0.020	59.2	0.602	-73.9
400	0.593	-158.7	17.954	99.0	0.029	60.4	0.444	-104.5
600	0.602	-166.8	12.350	89.5	0.039	63.6	0.404	-113.3
800	0.606	-174.8	9.160	83.7	0.049	65.9	0.359	-123.7
1000	0.608	179.2	7.261	79.3	0.059	67.0	0.341	-131.0
1200	0.612	174.4	6.025	75.7	0.069	67.5	0.327	-136.6
1400	0.614	170.2	5.149	72.2	0.079	67.4	0.321	-140.6
1600	0.615	166.4	4.503	69.0	0.089	67.2	0.316	-144.0
1800	0.618	162.9	4.004	66.0	0.100	66.4	0.314	-146.9
2000	0.619	159.8	3.619	63.1	0.110	65.8	0.316	-149.3
2200	0.618	156.5	3.299	60.1	0.120	64.9	0.319	-151.3
2400	0.618	153.5	3.035	57.3	0.130	63.9	0.322	-152.9
2600	0.617	150.5	2.816	54.4	0.141	62.7	0.326	-154.5
2800	0.617	147.4	2.630	51.7	0.150	61.6	0.334	-155.5
3000	0.614	144.2	2.469	49.0	0.160	60.3	0.342	-156.7
3200	0.611	141.0	2.328	46.1	0.170	58.9	0.351	-157.4
3400	0.611	137.6	2.204	43.4	0.180	57.5	0.360	-157.9
3600	0.609	134.3	2.095	40.7	0.189	56.1	0.372	-158.3
3800	0.608	130.8	1.995	38.0	0.199	54.7	0.383	-158.6
4000	0.606	127.2	1.906	35.3	0.209	53.1	0.395	-158.7
4200	0.607	123.6	1.824	32.6	0.218	51.5	0.407	-158.8
4400	0.607	120.1	1.749	30.1	0.226	49.9	0.419	-158.9
4600	0.607	116.5	1.681	27.6	0.235	48.3	0.430	-158.8
4800	0.608	113.0	1.616	25.0	0.243	46.8	0.440	-158.9
5000	0.608	109.6	1.560	22.6	0.251	45.2	0.450	-159.0

V_{CE}=3V, I_C=100mA

Freq(MHz)	S11	∠S11	S21	∠S21	S12	∠S12	S22	∠S22
200	0.577	-155.5	28.271	114.9	0.017	60.5	0.496	-77.8
400	0.645	-169.1	15.432	96.4	0.025	64.9	0.367	-105.8
600	0.649	-174.6	10.567	87.2	0.036	68.7	0.339	-111.9
800	0.656	179.3	7.841	81.8	0.046	70.5	0.306	-121.4
1000	0.658	174.4	6.227	77.4	0.056	71.3	0.295	-127.8
1200	0.663	170.4	5.172	73.6	0.066	71.6	0.287	-132.7
1400	0.666	166.8	4.421	70.1	0.076	71.2	0.285	-136.0
1600	0.668	163.4	3.860	66.9	0.087	70.6	0.285	-138.9
1800	0.671	160.2	3.443	63.7	0.097	69.8	0.287	-141.5
2000	0.672	157.5	3.108	60.7	0.107	69.1	0.292	-143.6
2200	0.671	154.3	2.835	57.5	0.118	68.1	0.297	-145.5
2400	0.672	151.4	2.606	54.5	0.128	67.0	0.304	-147.0
2600	0.671	148.6	2.419	51.5	0.139	65.7	0.311	-148.5
2800	0.671	145.6	2.260	48.7	0.148	64.4	0.321	-149.6
3000	0.669	142.6	2.122	45.9	0.159	63.1	0.332	-150.9
3200	0.665	139.5	2.001	42.9	0.169	61.7	0.345	-151.7
3400	0.666	136.2	1.895	40.1	0.179	60.2	0.357	-152.5
3600	0.664	132.9	1.800	37.3	0.189	58.6	0.371	-153.0
3800	0.663	129.5	1.713	34.5	0.199	57.1	0.385	-153.6
4000	0.662	126.0	1.635	31.7	0.209	55.5	0.399	-154.0
4200	0.663	122.5	1.562	29.0	0.218	53.9	0.414	-154.4
4400	0.663	119.1	1.497	26.4	0.227	52.3	0.428	-154.8
4600	0.663	115.5	1.438	23.9	0.236	50.6	0.441	-155.0
4800	0.664	112.0	1.381	21.3	0.245	48.9	0.453	-155.3
5000	0.664	108.7	1.333	18.9	0.253	47.3	0.464	-155.7

S Parameters (Common emitter)

 V_{CE}=5V, I_C=10mA

Freq(MHz)	S11	∠S11	S21	∠S21	S12	∠S12	S22	∠S22
200	0.674	-68.7	19.895	138.9	0.032	61.8	0.826	-41.4
400	0.653	-112.8	14.318	114.0	0.047	49.2	0.632	-67.8
600	0.651	-133.4	10.744	100.5	0.057	45.9	0.560	-79.3
800	0.626	-148.8	8.133	91.4	0.062	45.3	0.466	-88.2
1000	0.613	-159.3	6.522	84.8	0.067	46.0	0.415	-95.5
1200	0.610	-167.2	5.440	79.6	0.072	47.5	0.382	-100.9
1400	0.607	-173.5	4.659	74.9	0.078	48.7	0.363	-105.3
1600	0.606	-179.1	4.091	70.7	0.084	50.5	0.349	-109.4
1800	0.608	176.2	3.630	66.9	0.090	51.6	0.344	-112.7
2000	0.609	172.2	3.280	63.2	0.096	52.7	0.341	-116.0
2200	0.608	168.1	2.988	59.7	0.103	53.5	0.343	-118.8
2400	0.608	164.5	2.749	56.2	0.110	54.2	0.347	-121.6
2600	0.608	160.9	2.553	52.9	0.118	54.6	0.353	-124.4
2800	0.610	157.5	2.377	49.6	0.125	54.9	0.361	-126.4
3000	0.607	154.0	2.225	46.5	0.133	54.9	0.372	-128.8
3200	0.606	150.5	2.095	43.2	0.141	54.9	0.385	-130.8
3400	0.607	146.9	1.979	40.2	0.150	54.6	0.398	-132.6
3600	0.607	143.3	1.875	37.1	0.158	54.2	0.414	-134.3
3800	0.607	139.7	1.780	34.1	0.167	53.6	0.430	-136.0
4000	0.608	135.9	1.697	31.1	0.175	52.9	0.446	-137.4
4200	0.610	132.0	1.623	28.3	0.184	52.1	0.461	-138.8
4400	0.612	128.3	1.549	25.5	0.193	51.1	0.477	-140.0
4600	0.613	124.5	1.484	22.8	0.202	50.1	0.492	-141.1
4800	0.617	120.7	1.419	20.0	0.210	49.1	0.507	-142.0
5000	0.620	117.1	1.364	17.5	0.218	48.0	0.520	-143.0

 V_{CE}=5V, I_C=50mA

Freq(MHz)	S11	∠S11	S21	∠S21	S12	∠S12	S22	∠S22
200	0.489	-128.9	33.664	121.6	0.019	61.0	0.625	-65.5
400	0.568	-154.7	19.269	100.2	0.028	61.3	0.449	-94.0
600	0.579	-163.6	13.271	90.3	0.038	64.6	0.404	-102.5
800	0.583	-172.3	9.829	84.2	0.047	66.7	0.350	-112.6
1000	0.584	-178.7	7.784	79.6	0.056	67.8	0.325	-119.9
1200	0.589	176.2	6.443	75.8	0.066	68.5	0.308	-125.6
1400	0.591	171.8	5.505	72.3	0.076	68.4	0.300	-129.7
1600	0.593	167.9	4.817	69.1	0.085	68.1	0.295	-133.2
1800	0.595	164.3	4.280	66.0	0.095	67.6	0.292	-136.3
2000	0.596	161.2	3.857	63.1	0.105	67.0	0.294	-138.9
2200	0.596	157.8	3.517	60.1	0.115	66.1	0.296	-141.1
2400	0.596	154.7	3.234	57.2	0.124	65.1	0.300	-142.9
2600	0.595	151.7	3.000	54.3	0.134	63.9	0.306	-144.7
2800	0.596	148.5	2.799	51.5	0.144	62.8	0.313	-145.9
3000	0.593	145.4	2.625	48.7	0.154	61.6	0.323	-147.3
3200	0.591	142.2	2.472	45.9	0.163	60.2	0.334	-148.3
3400	0.591	138.8	2.340	43.1	0.173	59.0	0.344	-149.0
3600	0.589	135.4	2.221	40.4	0.182	57.7	0.358	-149.6
3800	0.589	131.9	2.114	37.6	0.191	56.2	0.371	-150.2
4000	0.588	128.3	2.017	34.9	0.201	54.6	0.385	-150.6
4200	0.588	124.7	1.929	32.2	0.209	53.1	0.399	-150.9
4400	0.589	121.1	1.847	29.6	0.218	51.7	0.412	-151.3
4600	0.590	117.5	1.773	27.1	0.227	50.1	0.426	-151.5
4800	0.590	113.9	1.702	24.4	0.235	48.6	0.438	-151.7
5000	0.592	110.6	1.642	22.0	0.243	47.0	0.450	-152.0

PACKAGE DIMENSIONS

unit : mm

SC-82FL / MCPH4

CASE 419AR

ISSUE O

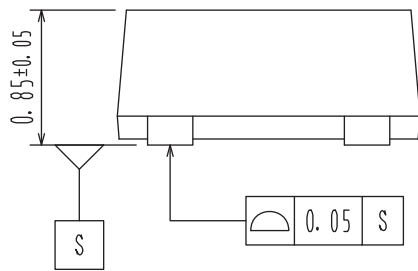
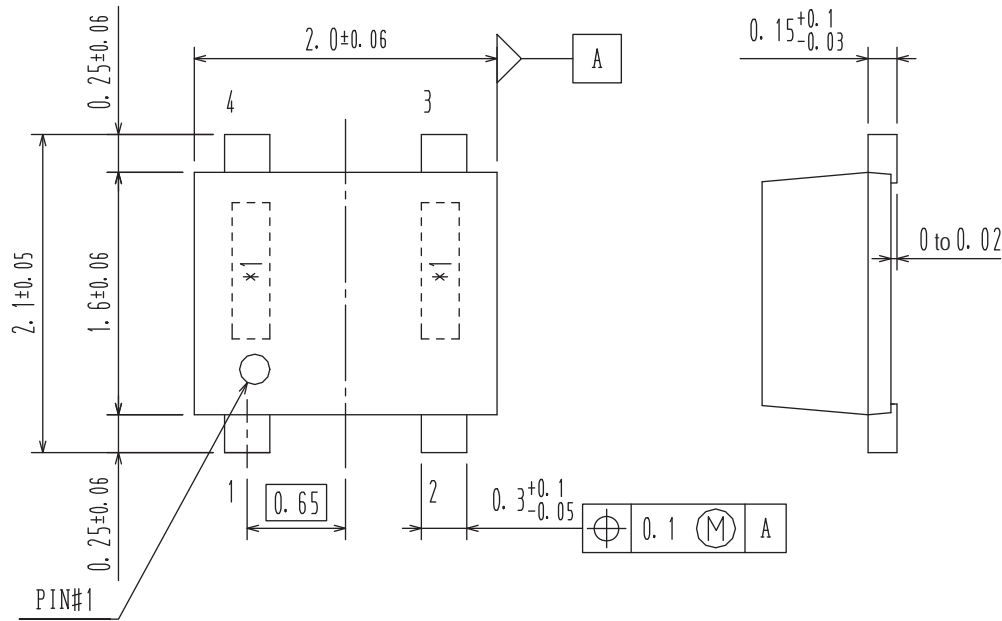

*1 : Lot Indication

RECOMMENDED SOLDERING FOOTPRINT

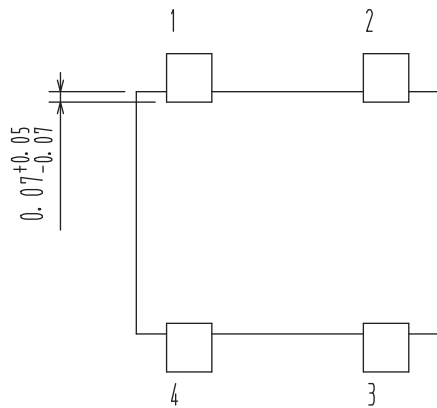
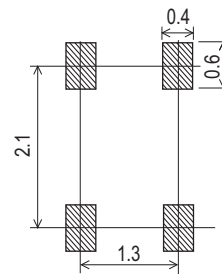

- 1 : Collector
- 2 : Emitter
- 3 : Base
- 4 : Emitter

ORDERING INFORMATION

Device	Marking	Package	Shipping (Qty / Packing)
NSVF4020SG4T1G	GT	SC-82FL / MCPH4 (Pb-Free / Halogen Free)	3,000 / Tape & Reel

† For information on tape and reel specifications, including part orientation and tape sizes, please refer to our Tape and Reel Packaging Specifications Brochure, BRD8011/D. http://www.onsemi.com/pub_link/Collateral/BRD8011-D.PDF

ON Semiconductor and the ON Semiconductor logo are trademarks of Semiconductor Components Industries, LLC dba ON Semiconductor or its subsidiaries in the United States and/or other countries. ON Semiconductor owns the rights to a number of patents, trademarks, copyrights, trade secrets, and other intellectual property. A listing of ON Semiconductor's product/patent coverage may be accessed at www.onsemi.com/site/pdf/Patent-Marking.pdf. ON Semiconductor reserves the right to make changes without further notice to any products herein. ON Semiconductor makes no warranty, representation or guarantee regarding the suitability of its products for any particular purpose, nor does ON Semiconductor assume any liability arising out of the application or use of any product or circuit, and specifically disclaims any and all liability, including without limitation special, consequential or incidental damages. Buyer is responsible for its products and applications using ON Semiconductor products, including compliance with all laws, regulations and safety requirements or standards, regardless of any support or applications information provided by ON Semiconductor. "Typical" parameters which may be provided in ON Semiconductor data sheets and/or specifications can and do vary in different applications and actual performance may vary over time. All operating parameters, including "Typicals" must be validated for each customer application by customer's technical experts. ON Semiconductor does not convey any license under its patent rights nor the rights of others. ON Semiconductor products are not designed, intended, or authorized for use as a critical component in life support systems or any FDA Class 3 medical devices or medical devices with a same or similar classification in a foreign jurisdiction or any devices intended for implantation in the human body. Should Buyer purchase or use ON Semiconductor products for any such unintended or unauthorized application, Buyer shall indemnify and hold ON Semiconductor and its officers, employees, subsidiaries, affiliates, and distributors harmless against all claims, costs, damages, and expenses, and reasonable attorney fees arising out of, directly or indirectly, any claim of personal injury or death associated with such unintended or unauthorized use, even if such claim alleges that ON Semiconductor was negligent regarding the design or manufacture of the part. ON Semiconductor is an Equal Opportunity/Affirmative Action Employer. This literature is subject to all applicable copyright laws and is not for resale in any manner.

X-ON Electronics

Largest Supplier of Electrical and Electronic Components

Click to view similar products for [RF Bipolar Transistors](#) category:

Click to view products by [ON Semiconductor](#) manufacturer:

Other Similar products are found below :

[MAPRST0912-50](#) [MCH4016-TL-H](#) [MMBT5551-G](#) [MRF10120](#) [15GN01CA-TB-E](#) [PH1214-25M](#) [MAPRST0912-350](#) [MMBTH10-TP](#) [BFP640F H6327](#) [BFP 720F H6327](#) [BFP 740F H6327](#) [BFR 360F H6765](#) [MRF10031](#) [NSVF4009SG4T1G](#) [BFP 182R E7764](#) [BFP405H6740XTSA1](#) [MRF10350](#) [ASMA201](#) [BFR360FH6765XTSA1](#) [BFP410H6327XTSA1](#) [BFP620FH7764XTSA1](#) [BFP720ESDH6327XTSA1](#) [BFP720FH6327XTSA1](#) [BFR360L3E6765XTMA1](#) [BFP420H6433XTMA1](#) [BFP420H6740XTSA1](#) [MCH4015-TL-H](#) [BF888H6327XTSA1](#) [MMBT2222A-G](#) [BFP196WH6327XTSA1](#) [BFP405FH6327XTSA1](#) [BFP640ESDH6327XTSA1](#) [BFR193L3E6327XTMA1](#) [BFS483H6327XTSA1](#) [NSVF4020SG4T1G](#) [NSVF6003SB6T1G](#) [MRF10005](#) [BFP420FH6327XTSA1](#) [BFP740FESDH6327XTSA1](#) [BFR181E6327HTSA1](#) [BFR181WH6327XTSA1](#) [BFR182E6327HTSA1](#) [BFR193E6327HTSA1](#) [BFP181E7764HTSA1](#) [BFP183WH6327XTSA1](#) [BFP720H6327XTSA1](#) [BFR182WH6327XTSA1](#) [BFU590GX](#) [MAPR-000912-500S00](#) [BFR340FH6327XTSA1](#)