

MUN531335DW1

Complementary Bias Resistor Transistors

NPN - R1=47 kΩ, R2=47 kΩ
PNP - R1=2.2 kΩ, R2=47 kΩ
 NPN and PNP Transistors with Monolithic Bias Resistor Network

This series of digital transistors is designed to replace a single device and its external resistor bias network. The Bias Resistor Transistor (BRT) contains a single transistor with a monolithic bias network consisting of two resistors; a series base resistor and a base-emitter resistor. The BRT eliminates these individual components by integrating them into a single device. The use of a BRT can reduce both system cost and board space.

Features

- Simplifies Circuit Design
- Reduces Board Space
- Reduces Component Count
- NSV Prefix for Automotive and Other Applications Requiring Unique Site and Control Change Requirements; AEC-Q101 Qualified and PPAP Capable
- These Devices are Pb-Free, Halogen Free/BFR Free and are RoHS Compliant

MAXIMUM RATINGS

(T_A = 25°C, common for Q₁ (PNP), unless otherwise noted)

Rating	Symbol	Max	Unit
Collector-Base Voltage	V _{CBO}	50	Vdc
Collector-Emitter Voltage	V _{CEO}	50	Vdc
Collector Current – Continuous	I _C	100	mAdc
Input Forward Voltage	V _{IN(fwd)}	12	Vdc
Input Reverse Voltage	V _{IN(rev)}	5	Vdc

MAXIMUM RATINGS

(T_A = 25°C, common for Q₂ (NPN), unless otherwise noted)

Rating	Symbol	Max	Unit
Collector-Base Voltage	V _{CBO}	50	Vdc
Collector-Emitter Voltage	V _{CEO}	50	Vdc
Collector Current – Continuous	I _C	100	mAdc
Input Forward Voltage	V _{IN(fwd)}	40	Vdc
Input Reverse Voltage	V _{IN(rev)}	10	Vdc

Stresses exceeding those listed in the Maximum Ratings table may damage the device. If any of these limits are exceeded, device functionality should not be assumed, damage may occur and reliability may be affected.



ON Semiconductor®

www.onsemi.com

PIN CONNECTIONS

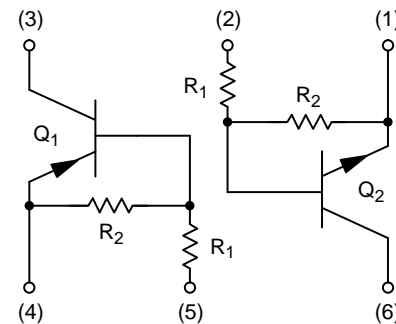

MARKING DIAGRAM



- AJ = Specific Device Code
- M = Date Code*
- = Pb-Free Package

(Note: Microdot may be in either location)

*Date Code orientation may vary depending upon manufacturing location.

ORDERING INFORMATION

Device	Package	Shipping†
NSVMUN531335DW1T1G	SOT-363 (Pb-Free)	3000 / Tape & Reel
NSVMUN531335DW1T3G	SOT-363 (Pb-Free)	10000 / Tape & Reel

†For information on tape and reel specifications, including part orientation and tape sizes, please refer to our Tape and Reel Packaging Specification Brochure, BRD8011/D.

MUN531335DW1

THERMAL CHARACTERISTICS

Characteristic	Symbol	Max	Unit
----------------	--------	-----	------

MUN531335DW1 (SOT-363) ONE JUNCTION HEATED

Total Device Dissipation $T_A = 25^\circ\text{C}$ (Note 1) (Note 2)	P_D	187	mW
Derate above 25°C (Note 1) (Note 2)		256 1.5 2.0	mW/ $^\circ\text{C}$
Thermal Resistance, Junction to Ambient (Note 1) (Note 2)	$R_{\theta JA}$	670 490	$^\circ\text{C/W}$

MUN531335DW1 (SOT-363) BOTH JUNCTION HEATED (Note 3)

Total Device Dissipation $T_A = 25^\circ\text{C}$ (Note 1) (Note 2)	P_D	250	mW
Derate above 25°C (Note 1) (Note 2)		385 2.0 3.0	mW/ $^\circ\text{C}$
Thermal Resistance, Junction to Ambient (Note 1) (Note 2)	$R_{\theta JA}$	493 325	$^\circ\text{C/W}$
Thermal Resistance, Junction to Lead (Note 1) (Note 2)	$R_{\theta JL}$	188 208	$^\circ\text{C/W}$
Junction and Storage Temperature Range	T_J, T_{stg}	-55 to +150	$^\circ\text{C}$

- FR-4 @ Minimum Pad.
- FR-4 @ 1.0×1.0 Inch Pad.
- Both junction heated values assume total power is sum of two equally powered channels.

MUN531335DW1

ELECTRICAL CHARACTERISTICS ($T_A = 25^\circ\text{C}$, common for Q₁ (PNP))

Characteristic	Symbol	Min	Typ	Max	Unit
OFF CHARACTERISTICS					
Collector–Base Cutoff Current ($V_{CB} = 50\text{ V}$, $I_E = 0$)	I_{CBO}	–	–	100	nAdc
Collector–Emitter Cutoff Current ($V_{CE} = 50\text{ V}$, $I_B = 0$)	I_{CEO}	–	–	500	nAdc
Emitter–Base Cutoff Current ($V_{EB} = 6.0\text{ V}$, $I_C = 0$)	I_{EBO}	–	–	0.2	mAdc
Collector–Base Breakdown Voltage ($I_C = 10\ \mu\text{A}$, $I_E = 0$)	$V_{(BR)CBO}$	50	–	–	Vdc
Collector–Emitter Breakdown Voltage (Note 4) ($I_C = 2.0\text{ mA}$, $I_B = 0$)	$V_{(BR)CEO}$	50	–	–	Vdc
ON CHARACTERISTICS					
DC Current Gain (Note 4) ($I_C = 5.0\text{ mA}$, $V_{CE} = 10\text{ V}$)	h_{FE}	80	140	–	
Collector–Emitter Saturation Voltage (Note 4) ($I_C = 10\text{ mA}$, $I_B = 0.3\text{ mA}$)	$V_{CE(sat)}$	–	–	0.25	Vdc
Input Voltage (off) ($V_{CE} = 5.0\text{ V}$, $I_C = 100\ \mu\text{A}$)	$V_{i(off)}$	–	0.6	–	Vdc
Input Voltage (on) ($V_{CE} = 0.2\text{ V}$, $I_C = 5.0\text{ mA}$)	$V_{i(on)}$	–	0.8	–	Vdc
Output Voltage (on) ($V_{CC} = 5.0\text{ V}$, $V_B = 2.5\text{ V}$, $R_L = 1.0\text{ k}\Omega$)	V_{OL}	–	–	0.2	Vdc
Output Voltage (off) ($V_{CC} = 5.0\text{ V}$, $V_B = 0.5\text{ V}$, $R_L = 1.0\text{ k}\Omega$)	V_{OH}	4.9	–	–	Vdc
Input Resistor	R_1	1.5	2.2	2.9	$\text{k}\Omega$
Resistor Ratio	R_1/R_2	0.038	0.047	0.056	

Product parametric performance is indicated in the Electrical Characteristics for the listed test conditions, unless otherwise noted. Product performance may not be indicated by the Electrical Characteristics if operated under different conditions.

4. Pulsed Condition: Pulse Width = 300 msec, Duty Cycle \leq 2%.

MUN531335DW1

ELECTRICAL CHARACTERISTICS (T_A = 25°C, common for Q₂ (NPN))

Characteristic	Symbol	Min	Typ	Max	Unit
OFF CHARACTERISTICS					
Collector-Base Cutoff Current (V _{CB} = 50 V, I _E = 0)	I _{CBO}	–	–	100	nAdc
Collector-Emitter Cutoff Current (V _{CE} = 50 V, I _B = 0)	I _{CEO}	–	–	500	nAdc
Emitter-Base Cutoff Current (V _{EB} = 6.0 V, I _C = 0)	I _{EBO}	–	–	0.1	mAdc
Collector-Base Breakdown Voltage (I _C = 10 μA, I _E = 0)	V _{(BR)CBO}	50	–	–	Vdc
Collector-Emitter Breakdown Voltage (Note 5) (I _C = 2.0 mA, I _B = 0)	V _{(BR)CEO}	50	–	–	Vdc

ON CHARACTERISTICS

DC Current Gain (Note 5) (I _C = 5.0 mA, V _{CE} = 10 V)	h _{FE}	80	140	–	
Collector-Emitter Saturation Voltage (Note 5) (I _C = 10 mA, I _B = 0.3 mA)	V _{CE(sat)}	–	–	0.25	V
Input Voltage (Off) (V _{CE} = 5.0 V, I _C = 100 μA)	V _{i(off)}	–	1.2	–	Vdc
Input Voltage (On) (V _{CE} = 0.2 V, I _C = 3.0 mA)	V _{i(on)}	–	1.9	–	Vdc
Output Voltage (On) (V _{CC} = 5.0 V, V _B = 3.5 V, R _L = 1.0 kΩ)	V _{OL}	–	–	0.2	Vdc
Output Voltage (Off) (V _{CC} = 5.0 V, V _B = 0.5 V, R _L = 1.0 kΩ)	V _{OH}	4.9	–	–	Vdc
Input Resistor	R1	32.9	47	61.1	kΩ
Resistor Ratio	R ₁ /R ₂	0.8	1.0	1.2	

Product parametric performance is indicated in the Electrical Characteristics for the listed test conditions, unless otherwise noted. Product performance may not be indicated by the Electrical Characteristics if operated under different conditions.

5. Pulsed Condition: Pulse Width = 300 ms, Duty Cycle ≤ 2%.

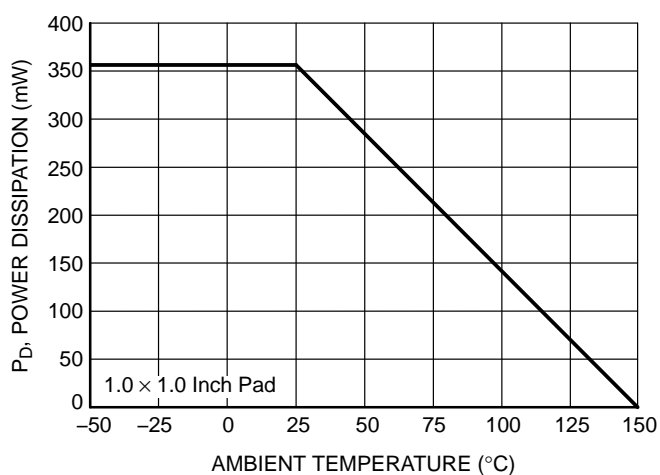

Figure 1. Derating Curve

TYPICAL CHARACTERISTICS – PNP TRANSISTOR

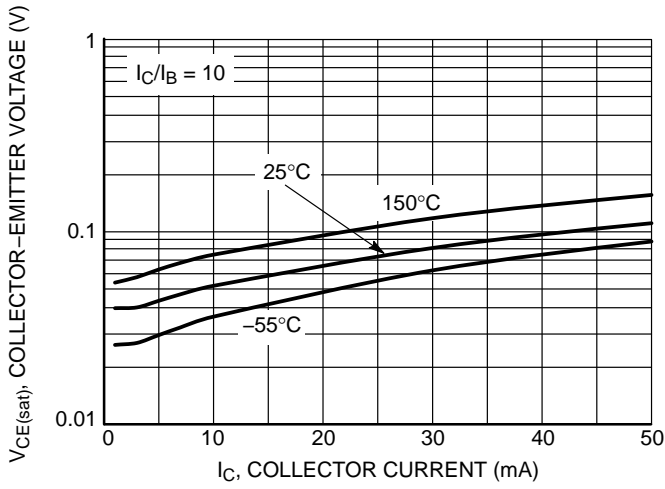

Figure 2. $V_{CE(sat)}$ vs. I_C

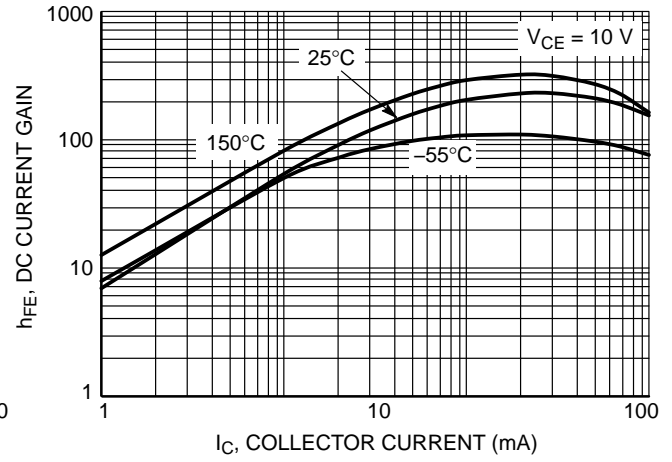

Figure 3. DC Current Gain

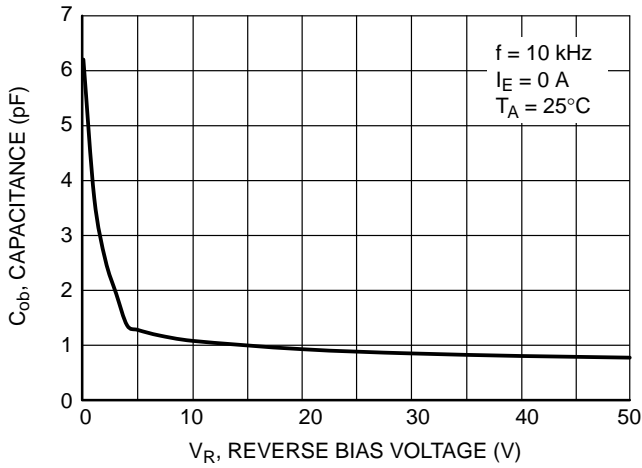

Figure 4. Output Capacitance

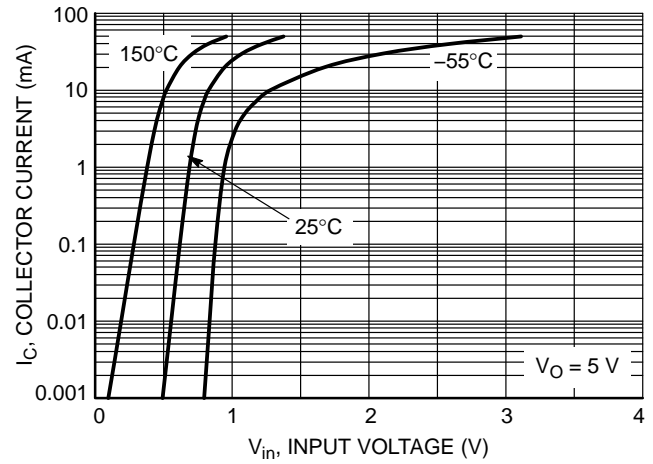

Figure 5. Output Current vs. Input Voltage

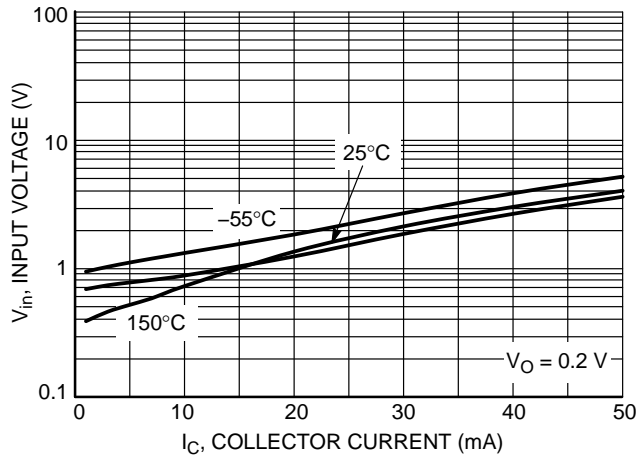

Figure 6. Input Voltage vs. Output Current

TYPICAL CHARACTERISTICS – NPN TRANSISTOR

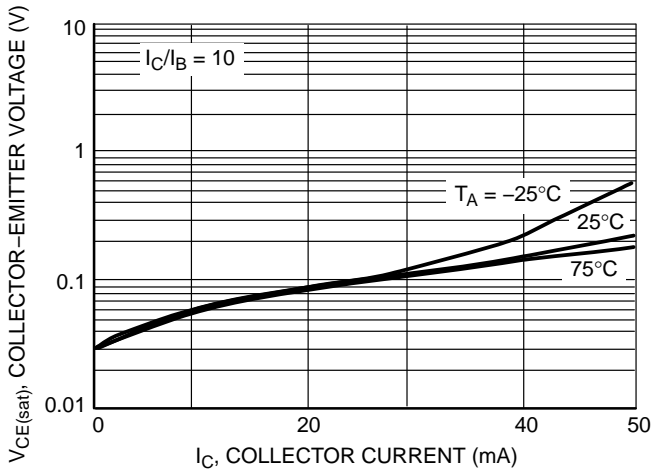

Figure 7. $V_{CE(sat)}$ vs. I_C

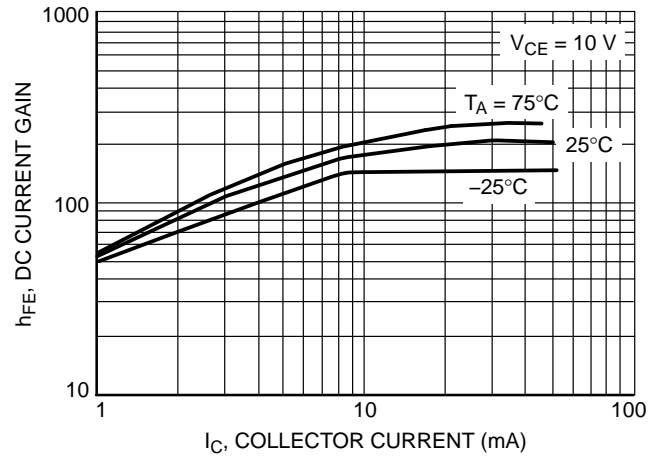

Figure 8. DC Current Gain

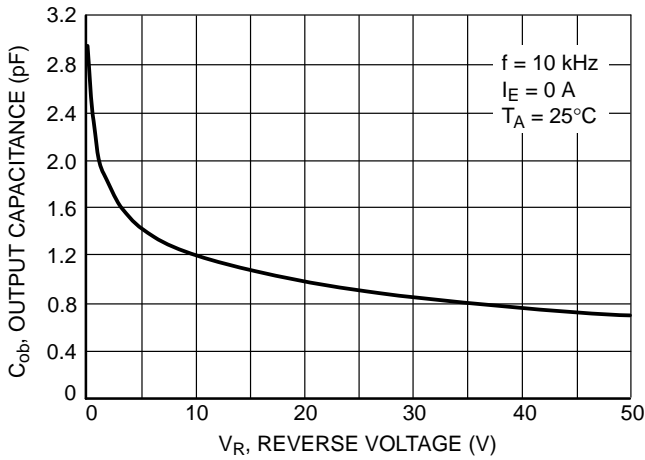

Figure 9. Output Capacitance

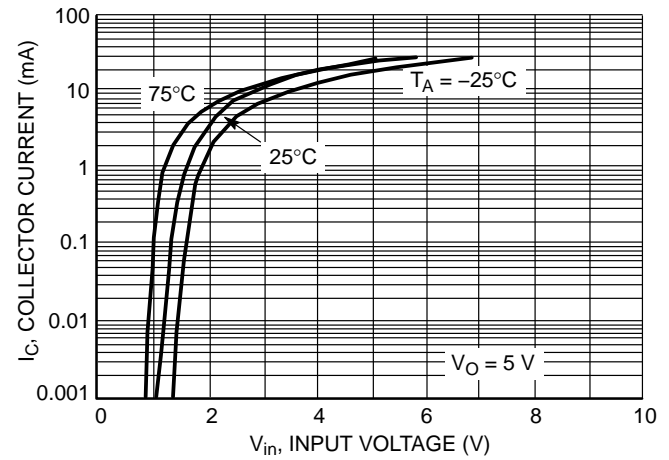

Figure 10. Output Current vs. Input Voltage

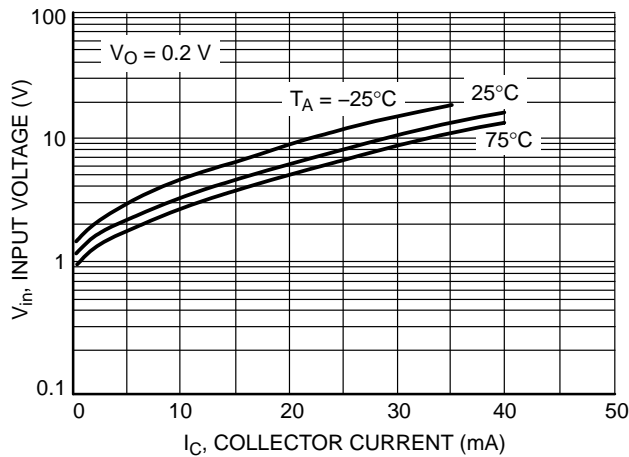

Figure 11. Input Voltage vs. Output Current



1
 SCALE 2:1

SC-88/SC70-6/SOT-363
 CASE 419B-02
 ISSUE Y

DATE 11 DEC 2012

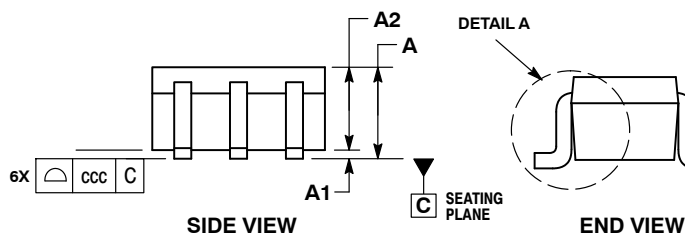
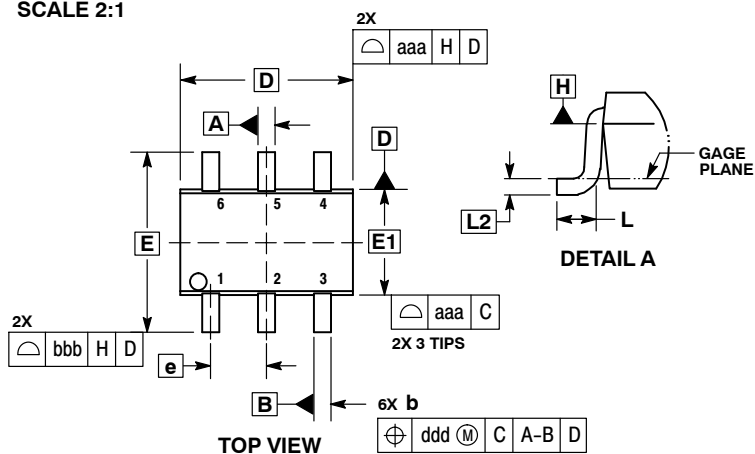

- NOTES:
1. DIMENSIONING AND TOLERANCING PER ASME Y14.5M, 1994.
 2. CONTROLLING DIMENSION: MILLIMETERS.
 3. DIMENSIONS D AND E1 DO NOT INCLUDE MOLD FLASH, PROTRUSIONS, OR GATE BURRS. MOLD FLASH, PROTRUSIONS, OR GATE BURRS SHALL NOT EXCEED 0.20 PER END.
 4. DIMENSIONS D AND E1 AT THE OUTERMOST EXTREMES OF THE PLASTIC BODY AND DATUM H.
 5. DATUMS A AND B ARE DETERMINED AT DATUM H.
 6. DIMENSIONS b AND c APPLY TO THE FLAT SECTION OF THE LEAD BETWEEN 0.08 AND 0.15 FROM THE TIP.
 7. DIMENSION b DOES NOT INCLUDE DAMBAR PROTRUSION. ALLOWABLE DAMBAR PROTRUSION SHALL BE 0.08 TOTAL IN EXCESS OF DIMENSION b AT MAXIMUM MATERIAL CONDITION. THE DAMBAR CANNOT BE LOCATED ON THE LOWER RADIUS OF THE FOOT.

DIM	MILLIMETERS			INCHES		
	MIN	NOM	MAX	MIN	NOM	MAX
A	---	---	1.10	---	---	0.043
A1	0.00	---	0.10	0.000	---	0.004
A2	0.70	0.90	1.00	0.027	0.035	0.039
b	0.15	0.20	0.25	0.006	0.008	0.010
C	0.08	0.15	0.22	0.003	0.006	0.009
D	1.80	2.00	2.20	0.070	0.078	0.086
E	2.00	2.10	2.20	0.078	0.082	0.086
E1	1.15	1.25	1.35	0.045	0.049	0.053
e	0.65 BSC			0.026 BSC		
L	0.26	0.36	0.46	0.010	0.014	0.018
L2	0.15 BSC			0.006 BSC		
aaa	0.15			0.006		
bbb	0.30			0.012		
ccc	0.10			0.004		
ddd	0.10			0.004		

GENERIC MARKING DIAGRAM*

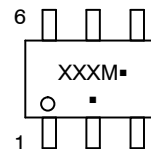

- XXX = Specific Device Code
- M = Date Code*
- = Pb-Free Package

(Note: Microdot may be in either location)

*Date Code orientation and/or position may vary depending upon manufacturing location.

*This information is generic. Please refer to device data sheet for actual part marking. Pb-Free indicator, "G" or microdot "▪", may or may not be present. Some products may not follow the Generic Marking.

RECOMMENDED SOLDERING FOOTPRINT*

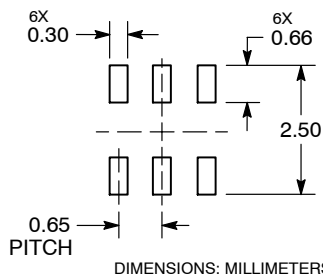

*For additional information on our Pb-Free strategy and soldering details, please download the ON Semiconductor Soldering and Mounting Techniques Reference Manual, SOLDERRM/D.

STYLES ON PAGE 2

DOCUMENT NUMBER:	98ASB42985B	Electronic versions are uncontrolled except when accessed directly from the Document Repository. Printed versions are uncontrolled except when stamped "CONTROLLED COPY" in red.
DESCRIPTION:	SC-88/SC70-6/SOT-363	PAGE 1 OF 2

ON Semiconductor and ON are trademarks of Semiconductor Components Industries, LLC dba ON Semiconductor or its subsidiaries in the United States and/or other countries. ON Semiconductor reserves the right to make changes without further notice to any products herein. ON Semiconductor makes no warranty, representation or guarantee regarding the suitability of its products for any particular purpose, nor does ON Semiconductor assume any liability arising out of the application or use of any product or circuit, and specifically disclaims any and all liability, including without limitation special, consequential or incidental damages. ON Semiconductor does not convey any license under its patent rights nor the rights of others.

SC-88/SC70-6/SOT-363
CASE 419B-02
ISSUE Y

DATE 11 DEC 2012

STYLE 1: PIN 1. EMITTER 2 2. BASE 2 3. COLLECTOR 1 4. EMITTER 1 5. BASE 1 6. COLLECTOR 2	STYLE 2: CANCELLED	STYLE 3: CANCELLED	STYLE 4: PIN 1. CATHODE 2. CATHODE 3. COLLECTOR 4. EMITTER 5. BASE 6. ANODE	STYLE 5: PIN 1. ANODE 2. ANODE 3. COLLECTOR 4. EMITTER 5. BASE 6. CATHODE	STYLE 6: PIN 1. ANODE 2 2. N/C 3. CATHODE 1 4. ANODE 1 5. N/C 6. CATHODE 2
STYLE 7: PIN 1. SOURCE 2 2. DRAIN 2 3. GATE 1 4. SOURCE 1 5. DRAIN 1 6. GATE 2	STYLE 8: CANCELLED	STYLE 9: PIN 1. EMITTER 2 2. EMITTER 1 3. COLLECTOR 1 4. BASE 1 5. BASE 2 6. COLLECTOR 2	STYLE 10: PIN 1. SOURCE 2 2. SOURCE 1 3. GATE 1 4. DRAIN 1 5. DRAIN 2 6. GATE 2	STYLE 11: PIN 1. CATHODE 2 2. CATHODE 2 3. ANODE 1 4. CATHODE 1 5. CATHODE 1 6. ANODE 2	STYLE 12: PIN 1. ANODE 2 2. ANODE 2 3. CATHODE 1 4. ANODE 1 5. ANODE 1 6. CATHODE 2
STYLE 13: PIN 1. ANODE 2. N/C 3. COLLECTOR 4. EMITTER 5. BASE 6. CATHODE	STYLE 14: PIN 1. VREF 2. GND 3. GND 4. IOUT 5. VEN 6. VCC	STYLE 15: PIN 1. ANODE 1 2. ANODE 2 3. ANODE 3 4. CATHODE 3 5. CATHODE 2 6. CATHODE 1	STYLE 16: PIN 1. BASE 1 2. EMITTER 2 3. COLLECTOR 2 4. BASE 2 5. EMITTER 1 6. COLLECTOR 1	STYLE 17: PIN 1. BASE 1 2. EMITTER 1 3. COLLECTOR 2 4. BASE 2 5. EMITTER 2 6. COLLECTOR 1	STYLE 18: PIN 1. VIN1 2. VCC 3. VOUT2 4. VIN2 5. GND 6. VOUT1
STYLE 19: PIN 1. IOUT 2. GND 3. GND 4. V CC 5. V EN 6. V REF	STYLE 20: PIN 1. COLLECTOR 2. COLLECTOR 3. BASE 4. EMITTER 5. COLLECTOR 6. COLLECTOR	STYLE 21: PIN 1. ANODE 1 2. N/C 3. ANODE 2 4. CATHODE 2 5. N/C 6. CATHODE 1	STYLE 22: PIN 1. D1 (i) 2. GND 3. D2 (i) 4. D2 (c) 5. VBUS 6. D1 (c)	STYLE 23: PIN 1. Vn 2. CH1 3. Vp 4. N/C 5. CH2 6. N/C	STYLE 24: PIN 1. CATHODE 2. ANODE 3. CATHODE 4. CATHODE 5. CATHODE 6. CATHODE
STYLE 25: PIN 1. BASE 1 2. CATHODE 3. COLLECTOR 2 4. BASE 2 5. EMITTER 6. COLLECTOR 1	STYLE 26: PIN 1. SOURCE 1 2. GATE 1 3. DRAIN 2 4. SOURCE 2 5. GATE 2 6. DRAIN 1	STYLE 27: PIN 1. BASE 2 2. BASE 1 3. COLLECTOR 1 4. EMITTER 1 5. EMITTER 2 6. COLLECTOR 2	STYLE 28: PIN 1. DRAIN 2. DRAIN 3. GATE 4. SOURCE 5. DRAIN 6. DRAIN	STYLE 29: PIN 1. ANODE 2. ANODE 3. COLLECTOR 4. EMITTER 5. BASE/ANODE 6. CATHODE	STYLE 30: PIN 1. SOURCE 1 2. DRAIN 2 3. DRAIN 2 4. SOURCE 2 5. GATE 1 6. DRAIN 1

Note: Please refer to datasheet for style callout. If style type is not called out in the datasheet refer to the device datasheet pinout or pin assignment.

DOCUMENT NUMBER:	98ASB42985B	Electronic versions are uncontrolled except when accessed directly from the Document Repository. Printed versions are uncontrolled except when stamped "CONTROLLED COPY" in red.
DESCRIPTION:	SC-88/SC70-6/SOT-363	PAGE 2 OF 2

ON Semiconductor and  are trademarks of Semiconductor Components Industries, LLC dba ON Semiconductor or its subsidiaries in the United States and/or other countries. ON Semiconductor reserves the right to make changes without further notice to any products herein. ON Semiconductor makes no warranty, representation or guarantee regarding the suitability of its products for any particular purpose, nor does ON Semiconductor assume any liability arising out of the application or use of any product or circuit, and specifically disclaims any and all liability, including without limitation special, consequential or incidental damages. ON Semiconductor does not convey any license under its patent rights nor the rights of others.

onsemi, **Onsemi**, and other names, marks, and brands are registered and/or common law trademarks of Semiconductor Components Industries, LLC dba "**onsemi**" or its affiliates and/or subsidiaries in the United States and/or other countries. **onsemi** owns the rights to a number of patents, trademarks, copyrights, trade secrets, and other intellectual property. A listing of **onsemi**'s product/patent coverage may be accessed at www.onsemi.com/site/pdf/Patent-Marking.pdf. **onsemi** reserves the right to make changes at any time to any products or information herein, without notice. The information herein is provided "as-is" and **onsemi** makes no warranty, representation or guarantee regarding the accuracy of the information, product features, availability, functionality, or suitability of its products for any particular purpose, nor does **onsemi** assume any liability arising out of the application or use of any product or circuit, and specifically disclaims any and all liability, including without limitation special, consequential or incidental damages. Buyer is responsible for its products and applications using **onsemi** products, including compliance with all laws, regulations and safety requirements or standards, regardless of any support or applications information provided by **onsemi**. "Typical" parameters which may be provided in **onsemi** data sheets and/or specifications can and do vary in different applications and actual performance may vary over time. All operating parameters, including "Typicals" must be validated for each customer application by customer's technical experts. **onsemi** does not convey any license under any of its intellectual property rights nor the rights of others. **onsemi** products are not designed, intended, or authorized for use as a critical component in life support systems or any FDA Class 3 medical devices or medical devices with a same or similar classification in a foreign jurisdiction or any devices intended for implantation in the human body. Should Buyer purchase or use **onsemi** products for any such unintended or unauthorized application, Buyer shall indemnify and hold **onsemi** and its officers, employees, subsidiaries, affiliates, and distributors harmless against all claims, costs, damages, and expenses, and reasonable attorney fees arising out of, directly or indirectly, any claim of personal injury or death associated with such unintended or unauthorized use, even if such claim alleges that **onsemi** was negligent regarding the design or manufacture of the part. **onsemi** is an Equal Opportunity/Affirmative Action Employer. This literature is subject to all applicable copyright laws and is not for resale in any manner.

PUBLICATION ORDERING INFORMATION

LITERATURE FULFILLMENT:

Email Requests to: orderlit@onsemi.com

onsemi Website: www.onsemi.com

TECHNICAL SUPPORT

North American Technical Support:

Voice Mail: 1 800-282-9855 Toll Free USA/Canada

Phone: 011 421 33 790 2910

Europe, Middle East and Africa Technical Support:

Phone: 00421 33 790 2910

For additional information, please contact your local Sales Representative

X-ON Electronics

Largest Supplier of Electrical and Electronic Components

Click to view similar products for [Bipolar Transistors - Pre-Biased](#) category:

Click to view products by [ON Semiconductor](#) manufacturer:

Other Similar products are found below :

[RN1607\(TE85L,F\)](#) [DTA124GKAT146](#) [DTA144WETL](#) [DTA144WKAT146](#) [DTC113EET1G](#) [DTC115TKAT146](#) [DTC144ECA-TP](#)
[DTC144VUAT106](#) [MUN5241T1G](#) [BCR158WH6327XTSA1](#) [NSBA114TDP6T5G](#) [NSBA143ZF3T5G](#) [NSBC114YF3T5G](#) [NSBC123TF3T5G](#)
[SMUN5235T1G](#) [SMUN5330DW1T1G](#) [SSVMUN5312DW1T2G](#) [RN1303\(TE85L,F\)](#) [RN4605\(TE85L,F\)](#) [TTEPROTOTYPE79](#)
[DDTC114EUAQ-7-F](#) [EMH15T2R](#) [SMUN2214T3G](#) [NSBC114TF3T5G](#) [NSBC143ZPDP6T5G](#) [NSVMUN5113DW1T3G](#)
[SMUN5230DW1T1G](#) [SMUN5133T1G](#) [SMUN2214T1G](#) [DTC114EUA-TP](#) [NSBA144EF3T5G](#) [NSVDTA114EET1G](#) [2SC2223-T1B-A](#)
[2SC3912-TB-E](#) [SMUN5237DW1T1G](#) [SMUN5213DW1T1G](#) [SMUN5114DW1T1G](#) [SMUN2111T1G](#) [NSVDTC144EM3T5G](#) [DTC124ECA-](#)
[TP](#) [DTC123TM3T5G](#) [DTA114ECA-TP](#) [DTA113EM3T5G](#) [DCX115EK-7-F](#) [DTC113EM3T5G](#) [NSVMUN5135DW1T1G](#)
[NSVDTC143ZM3T5G](#) [SMUN5335DW1T2G](#) [SMUN5216DW1T1G](#) [NSVMUN5312DW1T2G](#)