

NTB75N03R, NTP75N03R

Power MOSFET 75 Amps, 25 Volts N-Channel D²PAK, TO-220

Features

- Planar HD3e Process for Fast Switching Performance
- Low $R_{DS(on)}$ to Minimize Conduction Loss
- Low C_{iss} to Minimize Driver Loss
- Low Gate Charge
- Pb-Free Packages are Available

MAXIMUM RATINGS ($T_J = 25^\circ\text{C}$ Unless otherwise specified)

Parameter	Symbol	Value	Unit
Drain-to-Source Voltage	V_{DS}	25	V_{dc}
Gate-to-Source Voltage – Continuous	V_{GS}	± 20	V_{dc}
Thermal Resistance – Junction-to-Case	$R_{\theta JC}$	1.68	$^\circ\text{C/W}$
Total Power Dissipation @ $T_C = 25^\circ\text{C}$	P_D	74.4	W
Drain Current			
– Continuous @ $T_C = 25^\circ\text{C}$	I_D	75	A
– Single Pulse ($t_p = 10 \mu\text{s}$)	I_{DM}	225	A
Thermal Resistance – Junction-to-Ambient (Note 1)	$R_{\theta JA}$	60	$^\circ\text{C/W}$
Total Power Dissipation @ $T_A = 25^\circ\text{C}$	P_D	2.08	W
Drain Current – Continuous @ $T_A = 25^\circ\text{C}$	I_D	12.6	A
Thermal Resistance – Junction-to-Ambient (Note 2)	$R_{\theta JA}$	100	$^\circ\text{C/W}$
Total Power Dissipation @ $T_A = 25^\circ\text{C}$	P_D	1.25	W
Drain Current – Continuous @ $T_A = 25^\circ\text{C}$	I_D	9.7	A
Operating and Storage Temperature Range	T_J, T_{stg}	-55 to 150	$^\circ\text{C}$
Single Pulse Drain-to-Source Avalanche Energy – Starting $T_J = 25^\circ\text{C}$ ($V_{DD} = 30 V_{dc}$, $V_{GS} = 10 V_{dc}$, $I_L = 12 A_{pk}$, $L = 1 \text{ mH}$, $R_G = 25 \Omega$)	E_{AS}	71.7	mJ
Maximum Lead Temperature for Soldering Purposes, 1/8" from Case for 10 Seconds	T_L	260	$^\circ\text{C}$

Stresses exceeding Maximum Ratings may damage the device. Maximum Ratings are stress ratings only. Functional operation above the Recommended Operating Conditions is not implied. Extended exposure to stresses above the Recommended Operating Conditions may affect device reliability.

1. When surface mounted to an FR4 board using 1 inch pad size, (Cu Area 1.127 in²).
2. When surface mounted to an FR4 board using minimum recommended pad size, (Cu Area 0.412 in²).



ON Semiconductor®

<http://onsemi.com>

**75 AMPERES
25 VOLTS**

$R_{DS(on)} = 5.6 \text{ m}\Omega$ (Typ)

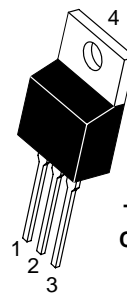

TO-220AB
CASE 221A
STYLE 5

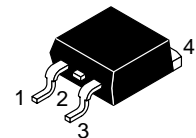

D²PAK
CASE 418B

MARKING DIAGRAMS & PIN ASSIGNMENTS

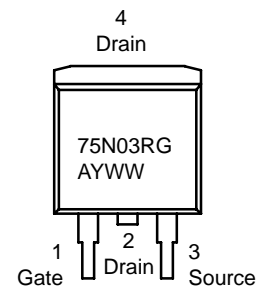
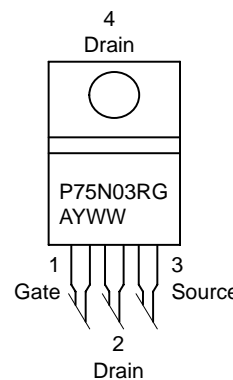

xxxxxxx = Device Code
G = Pb-Free Device
A = Assembly Location
Y = Year
WW = Work Week

ORDERING INFORMATION

See detailed ordering and shipping information in the package dimensions section on page 6 of this data sheet.

NTB75N03R, NTP75N03R

ELECTRICAL CHARACTERISTICS ($T_J = 25^\circ\text{C}$ Unless otherwise specified)

Characteristics	Symbol	Min	Typ	Max	Unit	
OFF CHARACTERISTICS						
Drain-to-Source Breakdown Voltage (Note 3) ($V_{GS} = 0 V_{dc}$, $I_D = 250 \mu A_{dc}$) Temperature Coefficient (Positive)	$V_{(br)DSS}$	25 –	28 20.5	– –	V_{dc} mV/ $^\circ\text{C}$	
Zero Gate Voltage Drain Current ($V_{DS} = 20 V_{dc}$, $V_{GS} = 0 V_{dc}$) ($V_{DS} = 20 V_{dc}$, $V_{GS} = 0 V_{dc}$, $T_J = 150^\circ\text{C}$)	I_{DSS}	– –	– –	1.0 10	μA_{dc}	
Gate-Body Leakage Current ($V_{GS} = \pm 20 V_{dc}$, $V_{DS} = 0 V_{dc}$)	I_{GSS}	–	–	± 100	nA $_{dc}$	
ON CHARACTERISTICS (Note 3)						
Gate Threshold Voltage (Note 3) ($V_{DS} = V_{GS}$, $I_D = 250 \mu A_{dc}$) Threshold Temperature Coefficient (Negative)	$V_{GS(th)}$	1.0 –	1.5 4.0	2.0 –	V_{dc} mV/ $^\circ\text{C}$	
Static Drain-to-Source On-Resistance (Note 3) ($V_{GS} = 4.5 V_{dc}$, $I_D = 20 A_{dc}$) ($V_{GS} = 10 V_{dc}$, $I_D = 20 A_{dc}$)	$R_{DS(on)}$	– –	8.1 5.6	13 8.0	m Ω	
Forward Transconductance (Note 3) ($V_{DS} = 10 V_{dc}$, $I_D = 15 A_{dc}$)	g_{FS}	–	27	–	Mhos	
DYNAMIC CHARACTERISTICS						
Input Capacitance	$(V_{DS} = 20 V_{dc}$, $V_{GS} = 0 V$, $f = 1 \text{ MHz}$)	C_{iss}	–	1333	–	pF
Output Capacitance		C_{oss}	–	600	–	
Transfer Capacitance		C_{rss}	–	218	–	
SWITCHING CHARACTERISTICS (Note 4)						
Turn-On Delay Time	$(V_{GS} = 10 V_{dc}$, $V_{DD} = 10 V_{dc}$, $I_D = 30 A_{dc}$, $R_G = 3 \Omega$)	$t_{d(on)}$	–	6.9	–	ns
Rise Time		t_r	–	1.3	–	
Turn-Off Delay Time		$t_{d(off)}$	–	18.4	–	
Fall Time		t_f	–	5.5	–	
Gate Charge	$(V_{GS} = 5 V_{dc}$, $I_D = 30 A_{dc}$, $V_{DS} = 10 V_{dc}$) (Note 3)	Q_T	–	13.2	–	nC
		Q_1	–	3.3	–	
		Q_2	–	6.2	–	
SOURCE-DRAIN DIODE CHARACTERISTICS						
Forward On-Voltage	$(I_S = 20 A_{dc}$, $V_{GS} = 0 V_{dc}$) (Note 3) $(I_S = 20 A_{dc}$, $V_{GS} = 0 V_{dc}$, $T_J = 125^\circ\text{C}$)	V_{SD}	– –	0.86 0.73	1.2 –	V_{dc}
Reverse Recovery Time		$(I_S = 35 A_{dc}$, $V_{GS} = 0 V_{dc}$, $dI_S/dt = 100 A/\mu\text{s}$) (Note 3)	t_{rr}	–	15.6	–
	t_a		–	13.8	–	
	t_b		–	1.78	–	
Reverse Recovery Stored Charge		Q_{RR}	–	0.004	–	μC

3. Pulse Test: Pulse Width = 300 μs , Duty Cycle = 2%.

4. Switching characteristics are independent of operating junction temperatures.

NTB75N03R, NTP75N03R

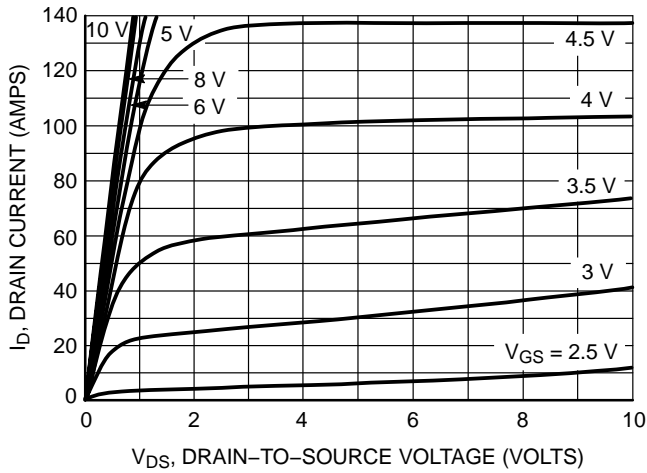

Figure 1. On-Region Characteristics

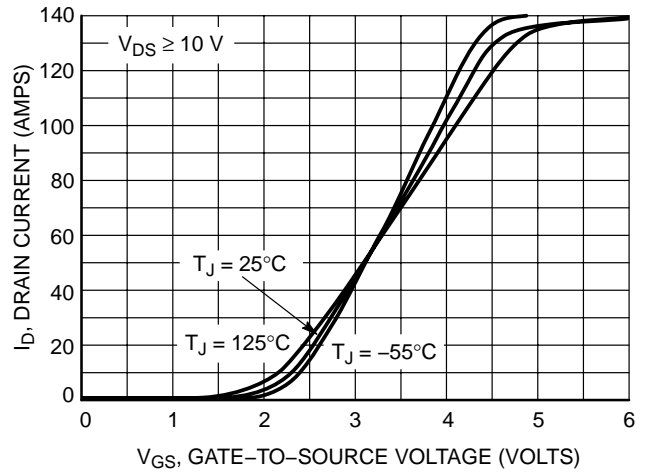

Figure 2. Transfer Characteristics

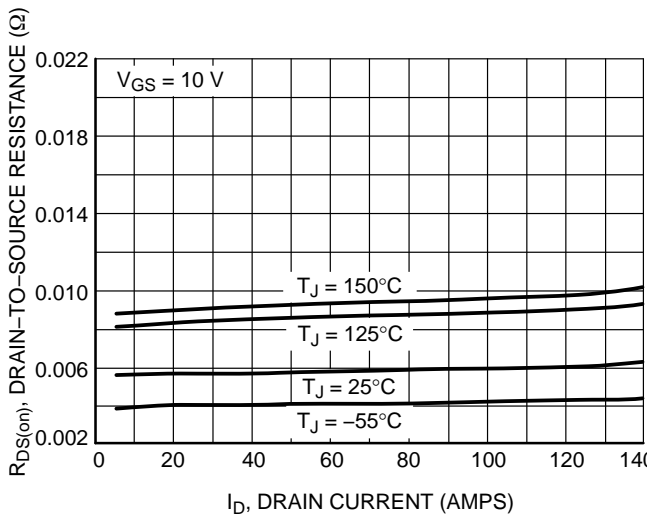

Figure 3. On-Resistance versus Drain Current and Temperature

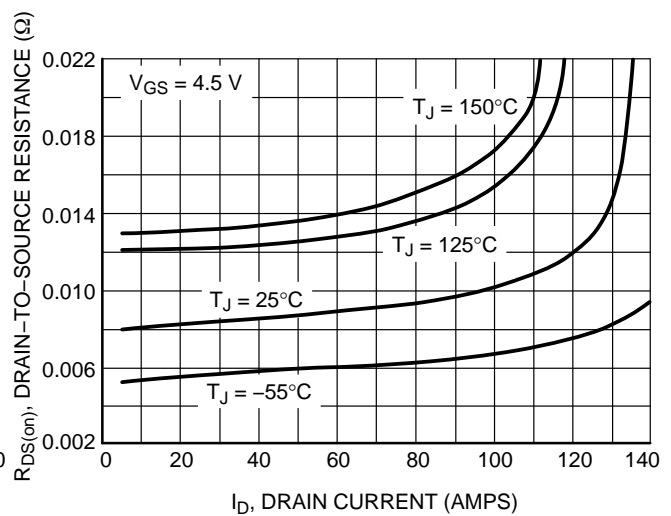

Figure 4. On-Resistance versus Drain Current and Temperature

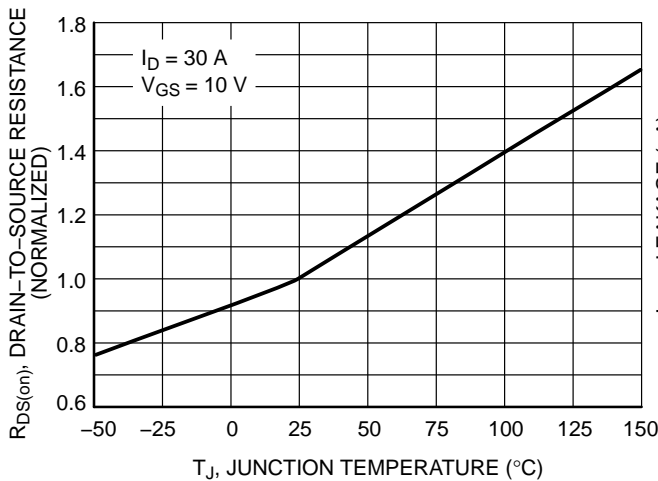

Figure 5. On-Resistance Variation with Temperature

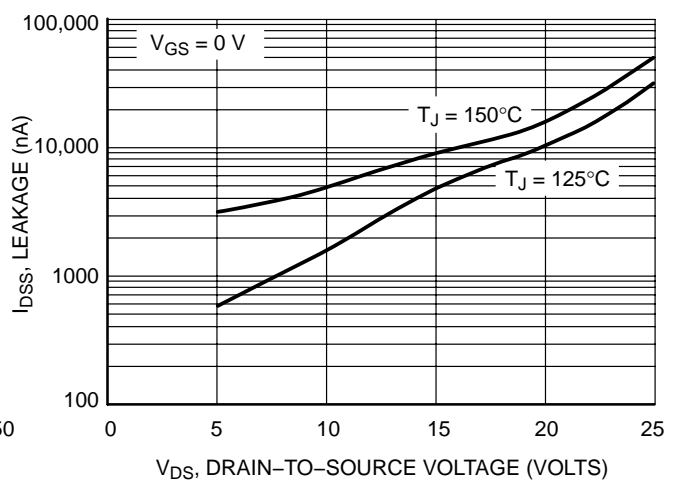

Figure 6. Drain-to-Source Leakage Current versus Voltage

POWER MOSFET SWITCHING

Switching behavior is most easily modeled and predicted by recognizing that the power MOSFET is charge controlled. The lengths of various switching intervals (Δt) are determined by how fast the FET input capacitance can be charged by current from the generator.

The published capacitance data is difficult to use for calculating rise and fall because drain–gate capacitance varies greatly with applied voltage. Accordingly, gate charge data is used. In most cases, a satisfactory estimate of average input current ($I_{G(AV)}$) can be made from a rudimentary analysis of the drive circuit so that

$$t = Q/I_{G(AV)}$$

During the rise and fall time interval when switching a resistive load, V_{GS} remains virtually constant at a level known as the plateau voltage, V_{SGSP} . Therefore, rise and fall times may be approximated by the following:

$$t_r = Q_2 \times R_G / (V_{GG} - V_{SGSP})$$

$$t_f = Q_2 \times R_G / V_{SGSP}$$

where

V_{GG} = the gate drive voltage, which varies from zero to V_{GG}

R_G = the gate drive resistance

and Q_2 and V_{SGSP} are read from the gate charge curve.

During the turn–on and turn–off delay times, gate current is not constant. The simplest calculation uses appropriate values from the capacitance curves in a standard equation for voltage change in an RC network. The equations are:

$$t_{d(on)} = R_G C_{iss} \ln [V_{GG}/(V_{GG} - V_{SGSP})]$$

$$t_{d(off)} = R_G C_{iss} \ln (V_{GG}/V_{SGSP})$$

The capacitance (C_{iss}) is read from the capacitance curve at a voltage corresponding to the off–state condition when calculating $t_{d(on)}$ and is read at a voltage corresponding to the on–state when calculating $t_{d(off)}$.

At high switching speeds, parasitic circuit elements complicate the analysis. The inductance of the MOSFET source lead, inside the package and in the circuit wiring which is common to both the drain and gate current paths, produces a voltage at the source which reduces the gate drive current. The voltage is determined by $L di/dt$, but since di/dt is a function of drain current, the mathematical solution is complex. The MOSFET output capacitance also complicates the mathematics. And finally, MOSFETs have finite internal gate resistance which effectively adds to the resistance of the driving source, but the internal resistance is difficult to measure and, consequently, is not specified.

The resistive switching time variation versus gate resistance (Figure 9) shows how typical switching performance is affected by the parasitic circuit elements. If the parasitics were not present, the slope of the curves would maintain a value of unity regardless of the switching speed. The circuit used to obtain the data is constructed to minimize common inductance in the drain and gate circuit loops and is believed readily achievable with board mounted components. Most power electronic loads are inductive; the data in the figure is taken with a resistive load, which approximates an optimally snubbed inductive load. Power MOSFETs may be safely operated into an inductive load; however, snubbing reduces switching losses.

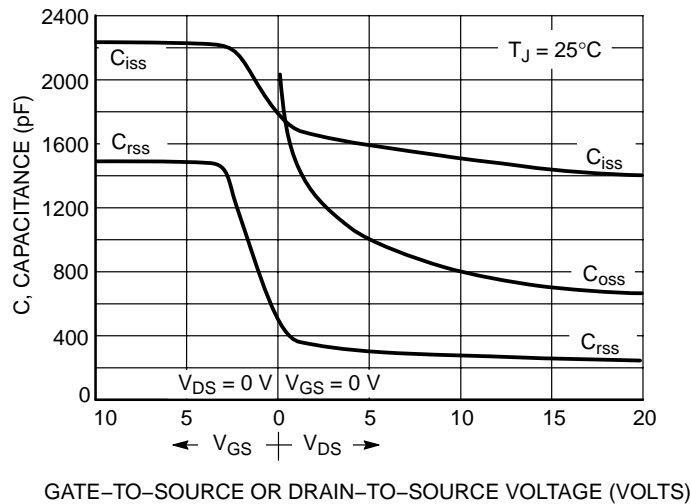

Figure 7. Capacitance Variation

NTB75N03R, NTP75N03R

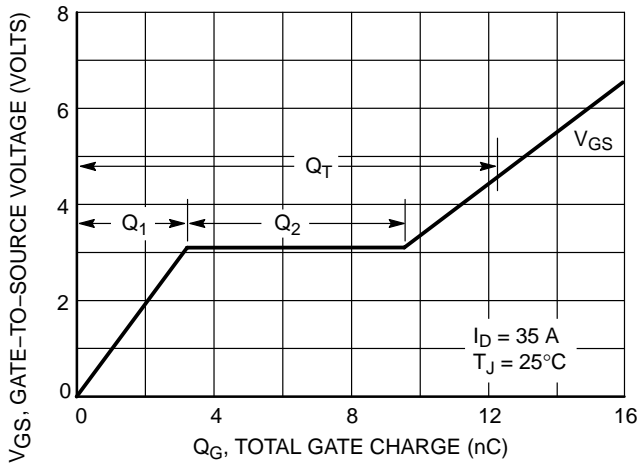

Figure 8. Gate-to-Source and Drain-to-Source Voltage versus Total Charge

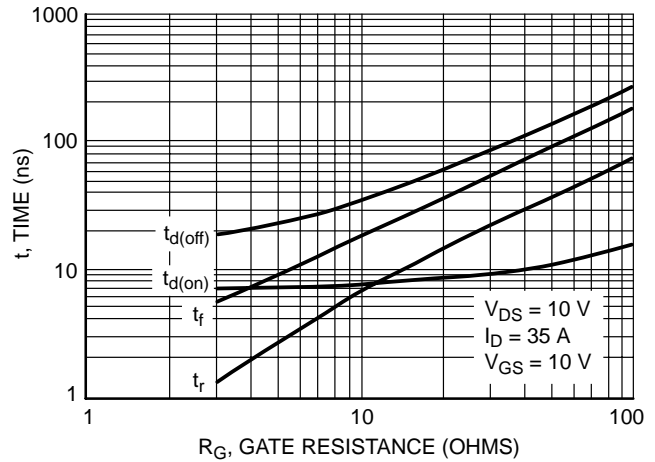

Figure 9. Resistive Switching Time Variation versus Gate Resistance

DRAIN-TO-SOURCE DIODE CHARACTERISTICS

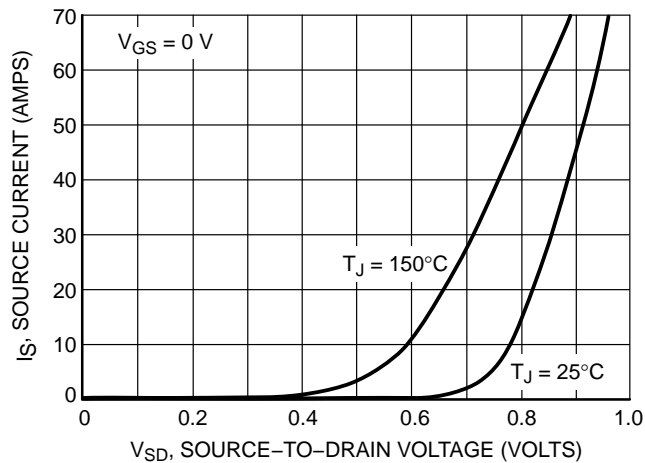

Figure 10. Diode Forward Voltage versus Current

SAFE OPERATING AREA

The Forward Biased Safe Operating Area curves define the maximum simultaneous drain-to-source voltage and drain current that a transistor can handle safely when it is forward biased. Curves are based upon maximum peak junction temperature and a case temperature (T_C) of 25°C. Peak repetitive pulsed power limits are determined by using the thermal response data in conjunction with the procedures discussed in AN569, “Transient Thermal Resistance – General Data and Its Use.”

Switching between the off-state and the on-state may traverse any load line provided neither rated peak current (I_{DM}) nor rated voltage (V_{DSS}) is exceeded and the transition time (t_r, t_f) do not exceed 10 μ s. In addition the total power averaged over a complete switching cycle must not exceed $(T_{J(MAX)} - T_C)/(R_{\theta JC})$.

A Power MOSFET designated E-FET can be safely used in switching circuits with unclamped inductive loads. For

reliable operation, the stored energy from circuit inductance dissipated in the transistor while in avalanche must be less than the rated limit and adjusted for operating conditions differing from those specified. Although industry practice is to rate in terms of energy, avalanche energy capability is not a constant. The energy rating decreases non-linearly with an increase of peak current in avalanche and peak junction temperature.

Although many E-FETs can withstand the stress of drain-to-source avalanche at currents up to rated pulsed current (I_{DM}), the energy rating is specified at rated continuous current (I_D), in accordance with industry custom. The energy rating must be derated for temperature as shown in the accompanying graph (Figure 12). Maximum energy at currents below rated continuous I_D can safely be assumed to equal the values indicated.

NTB75N03R, NTP75N03R

SAFE OPERATING AREA

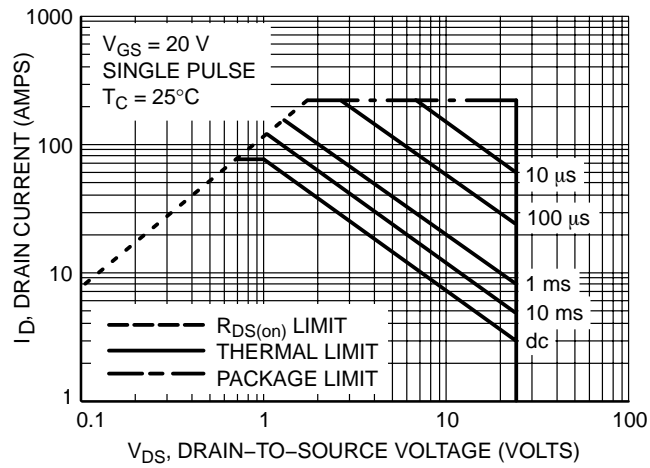

Figure 11. Maximum Rated Forward Biased Safe Operating Area

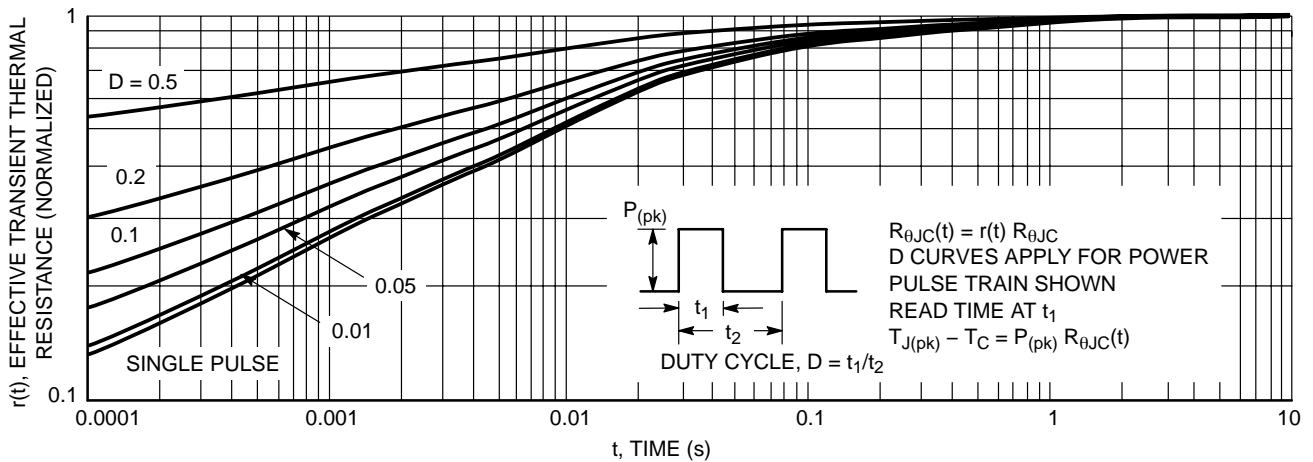

Figure 12. Thermal Response

ORDERING INFORMATION

Device	Package	Shipping†
NTP75N03R	TO-220AB	50 Units / Rail
NTB75N03R	D ² PAK	50 Units / Rail
NTB75N03RG	D ² PAK (Pb-Free)	50 Units / Rail
NTB75N03RT4	D ² PAK	800 Tape & Reel
NTB75N03RT4G	D ² PAK (Pb-Free)	800 Tape & Reel

†For information on tape and reel specifications, including part orientation and tape sizes, please refer to our Tape and Reel Packaging Specifications Brochure, BRD8011/D.

MECHANICAL CASE OUTLINE

PACKAGE DIMENSIONS

ON Semiconductor®

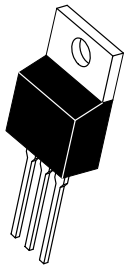

SCALE 1:1

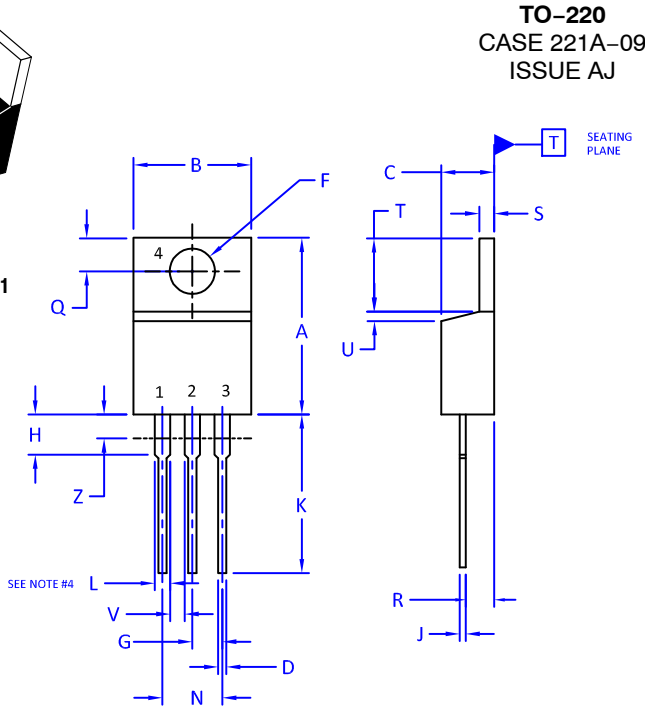

TO-220
CASE 221A-09
ISSUE AJ

DATE 05 NOV 2019

NOTES:

1. DIMENSIONING AND TOLERANCING PER ANSI Y14.5M, 2009.
2. CONTROLLING DIMENSION: INCHES
3. DIMENSION Z DEFINES A ZONE WHERE ALL BODY AND LEAD IRREGULARITIES ARE ALLOWED.
4. MAX WIDTH FOR F102 DEVICE = 1.35MM

DIM	INCHES		MILLIMETERS	
	MIN.	MAX.	MIN.	MAX.
A	0.570	0.620	14.48	15.75
B	0.380	0.415	9.66	10.53
C	0.160	0.190	4.07	4.83
D	0.025	0.038	0.64	0.96
F	0.142	0.161	3.60	4.09
G	0.095	0.105	2.42	2.66
H	0.110	0.161	2.80	4.10
J	0.014	0.024	0.36	0.61
K	0.500	0.562	12.70	14.27
L	0.045	0.060	1.15	1.52
N	0.190	0.210	4.83	5.33
Q	0.100	0.120	2.54	3.04
R	0.080	0.110	2.04	2.79
S	0.045	0.055	1.15	1.41
T	0.235	0.255	5.97	6.47
U	0.000	0.050	0.00	1.27
V	0.045	---	1.15	---
Z	---	0.080	---	2.04

STYLE 1:

- PIN 1. BASE
- 2. COLLECTOR
- 3. EMITTER
- 4. COLLECTOR

STYLE 2:

- PIN 1. BASE
- 2. EMITTER
- 3. COLLECTOR
- 4. EMITTER

STYLE 3:

- PIN 1. CATHODE
- 2. ANODE
- 3. GATE
- 4. ANODE

STYLE 4:

- PIN 1. MAIN TERMINAL 1
- 2. MAIN TERMINAL 2
- 3. GATE
- 4. MAIN TERMINAL 2

STYLE 5:

- PIN 1. GATE
- 2. DRAIN
- 3. SOURCE
- 4. DRAIN

STYLE 6:

- PIN 1. ANODE
- 2. CATHODE
- 3. ANODE
- 4. CATHODE

STYLE 7:

- PIN 1. CATHODE
- 2. ANODE
- 3. CATHODE
- 4. ANODE

STYLE 8:

- PIN 1. CATHODE
- 2. ANODE
- 3. EXTERNAL TRIP/DELAY
- 4. ANODE

STYLE 9:

- PIN 1. GATE
- 2. COLLECTOR
- 3. EMITTER
- 4. COLLECTOR

STYLE 10:

- PIN 1. GATE
- 2. SOURCE
- 3. DRAIN
- 4. SOURCE

STYLE 11:

- PIN 1. DRAIN
- 2. SOURCE
- 3. GATE
- 4. SOURCE

STYLE 12:

- PIN 1. MAIN TERMINAL 1
- 2. MAIN TERMINAL 2
- 3. GATE
- 4. NOT CONNECTED

DOCUMENT NUMBER:	98ASB42148B	Electronic versions are uncontrolled except when accessed directly from the Document Repository. Printed versions are uncontrolled except when stamped "CONTROLLED COPY" in red.
DESCRIPTION:	TO-220	PAGE 1 OF 1

ON Semiconductor and are trademarks of Semiconductor Components Industries, LLC dba ON Semiconductor or its subsidiaries in the United States and/or other countries. ON Semiconductor reserves the right to make changes without further notice to any products herein. ON Semiconductor makes no warranty, representation or guarantee regarding the suitability of its products for any particular purpose, nor does ON Semiconductor assume any liability arising out of the application or use of any product or circuit, and specifically disclaims any and all liability, including without limitation special, consequential or incidental damages. ON Semiconductor does not convey any license under its patent rights nor the rights of others.

MECHANICAL CASE OUTLINE PACKAGE DIMENSIONS

ON Semiconductor®



D²PAK 3
CASE 418B-04
ISSUE L

DATE 17 FEB 2015

SCALE 1:1

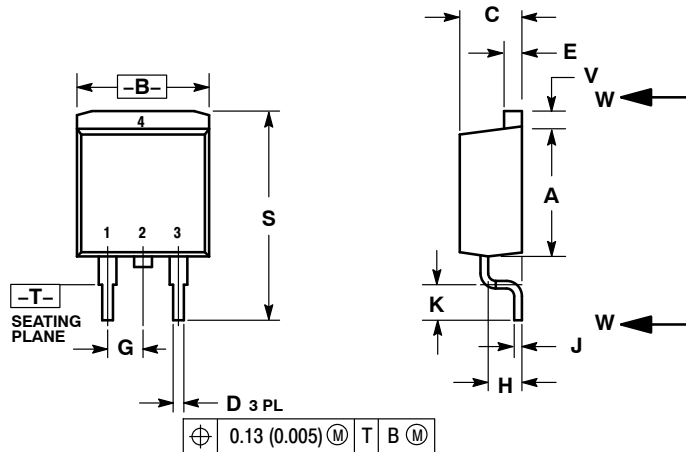

NOTES:

1. DIMENSIONING AND TOLERANCING PER ANSI Y14.5M, 1982.
2. CONTROLLING DIMENSION: INCH.
3. 418B-01 THRU 418B-03 OBSOLETE, NEW STANDARD 418B-04.

DIM	INCHES		MILLIMETERS	
	MIN	MAX	MIN	MAX
A	0.340	0.380	8.64	9.65
B	0.380	0.405	9.65	10.29
C	0.160	0.190	4.06	4.83
D	0.020	0.035	0.51	0.89
E	0.045	0.055	1.14	1.40
F	0.310	0.350	7.87	8.89
G	0.100	BSC	2.54	BSC
H	0.080	0.110	2.03	2.79
J	0.018	0.025	0.46	0.64
K	0.090	0.110	2.29	2.79
L	0.052	0.072	1.32	1.83
M	0.280	0.320	7.11	8.13
N	0.197	REF	5.00	REF
P	0.079	REF	2.00	REF
R	0.039	REF	0.99	REF
S	0.575	0.625	14.60	15.88
V	0.045	0.055	1.14	1.40

VARIABLE CONFIGURATION ZONE

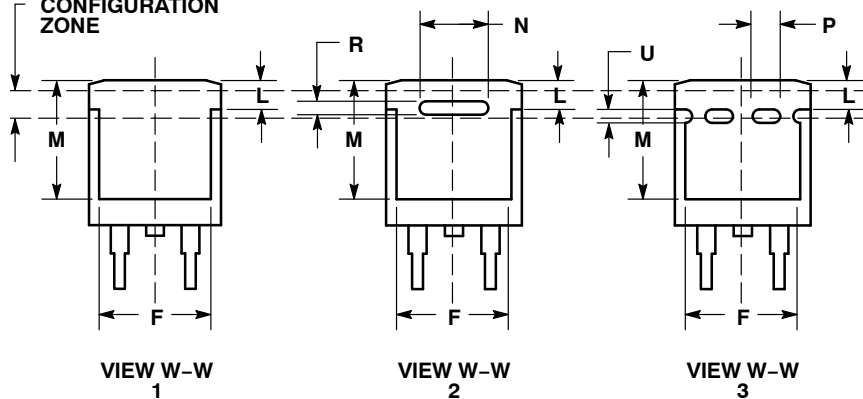

- | | | | | | |
|--|---|---|--|---|--|
| STYLE 1:
PIN 1. BASE
2. COLLECTOR
3. EMITTER
4. COLLECTOR | STYLE 2:
PIN 1. GATE
2. DRAIN
3. SOURCE
4. DRAIN | STYLE 3:
PIN 1. ANODE
2. CATHODE
3. ANODE
4. CATHODE | STYLE 4:
PIN 1. GATE
2. COLLECTOR
3. EMITTER
4. COLLECTOR | STYLE 5:
PIN 1. CATHODE
2. ANODE
3. CATHODE
4. ANODE | STYLE 6:
PIN 1. NO CONNECT
2. CATHODE
3. ANODE
4. CATHODE |
|--|---|---|--|---|--|

MARKING INFORMATION AND FOOTPRINT ON PAGE 2

DOCUMENT NUMBER:	98ASB42761B	Electronic versions are uncontrolled except when accessed directly from the Document Repository. Printed versions are uncontrolled except when stamped "CONTROLLED COPY" in red.
DESCRIPTION:	D²PAK 3	PAGE 1 OF 2

ON Semiconductor and ON are trademarks of Semiconductor Components Industries, LLC dba ON Semiconductor or its subsidiaries in the United States and/or other countries. ON Semiconductor reserves the right to make changes without further notice to any products herein. ON Semiconductor makes no warranty, representation or guarantee regarding the suitability of its products for any particular purpose, nor does ON Semiconductor assume any liability arising out of the application or use of any product or circuit, and specifically disclaims any and all liability, including without limitation special, consequential or incidental damages. ON Semiconductor does not convey any license under its patent rights nor the rights of others.

D²PAK 3
CASE 418B-04
ISSUE L

DATE 17 FEB 2015

**GENERIC
MARKING DIAGRAM***

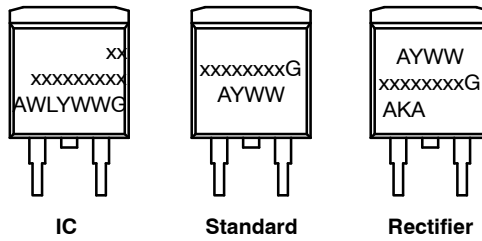

- xx = Specific Device Code
- A = Assembly Location
- WL = Wafer Lot
- Y = Year
- WW = Work Week
- G = Pb-Free Package
- AKA = Polarity Indicator

*This information is generic. Please refer to device data sheet for actual part marking. Pb-Free indicator, "G" or microdot "•", may or may not be present.

SOLDERING FOOTPRINT*

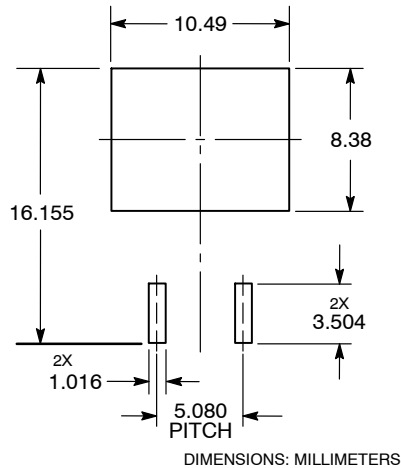

*For additional information on our Pb-Free strategy and soldering details, please download the ON Semiconductor Soldering and Mounting Techniques Reference Manual, SOLDERRM/D.

DOCUMENT NUMBER:	98ASB42761B	Electronic versions are uncontrolled except when accessed directly from the Document Repository. Printed versions are uncontrolled except when stamped "CONTROLLED COPY" in red.
DESCRIPTION:	D²PAK 3	PAGE 2 OF 2

ON Semiconductor and are trademarks of Semiconductor Components Industries, LLC dba ON Semiconductor or its subsidiaries in the United States and/or other countries. ON Semiconductor reserves the right to make changes without further notice to any products herein. ON Semiconductor makes no warranty, representation or guarantee regarding the suitability of its products for any particular purpose, nor does ON Semiconductor assume any liability arising out of the application or use of any product or circuit, and specifically disclaims any and all liability, including without limitation special, consequential or incidental damages. ON Semiconductor does not convey any license under its patent rights nor the rights of others.

ON Semiconductor and  are trademarks of Semiconductor Components Industries, LLC dba ON Semiconductor or its subsidiaries in the United States and/or other countries. ON Semiconductor owns the rights to a number of patents, trademarks, copyrights, trade secrets, and other intellectual property. A listing of ON Semiconductor's product/patent coverage may be accessed at www.onsemi.com/site/pdf/Patent-Markings.pdf. ON Semiconductor reserves the right to make changes without further notice to any products herein. ON Semiconductor makes no warranty, representation or guarantee regarding the suitability of its products for any particular purpose, nor does ON Semiconductor assume any liability arising out of the application or use of any product or circuit, and specifically disclaims any and all liability, including without limitation special, consequential or incidental damages. Buyer is responsible for its products and applications using ON Semiconductor products, including compliance with all laws, regulations and safety requirements or standards, regardless of any support or applications information provided by ON Semiconductor. "Typical" parameters which may be provided in ON Semiconductor data sheets and/or specifications can and do vary in different applications and actual performance may vary over time. All operating parameters, including "Typicals" must be validated for each customer application by customer's technical experts. ON Semiconductor does not convey any license under its patent rights nor the rights of others. ON Semiconductor products are not designed, intended, or authorized for use as a critical component in life support systems or any FDA Class 3 medical devices or medical devices with a same or similar classification in a foreign jurisdiction or any devices intended for implantation in the human body. Should Buyer purchase or use ON Semiconductor products for any such unintended or unauthorized application, Buyer shall indemnify and hold ON Semiconductor and its officers, employees, subsidiaries, affiliates, and distributors harmless against all claims, costs, damages, and expenses, and reasonable attorney fees arising out of, directly or indirectly, any claim of personal injury or death associated with such unintended or unauthorized use, even if such claim alleges that ON Semiconductor was negligent regarding the design or manufacture of the part. ON Semiconductor is an Equal Opportunity/Affirmative Action Employer. This literature is subject to all applicable copyright laws and is not for resale in any manner.

PUBLICATION ORDERING INFORMATION

LITERATURE FULFILLMENT:

Email Requests to: orderlit@onsemi.com

ON Semiconductor Website: www.onsemi.com

TECHNICAL SUPPORT

North American Technical Support:
Voice Mail: 1 800-282-9855 Toll Free USA/Canada
Phone: 011 421 33 790 2910

Europe, Middle East and Africa Technical Support:

Phone: 00421 33 790 2910

For additional information, please contact your local Sales Representative

X-ON Electronics

Largest Supplier of Electrical and Electronic Components

Click to view similar products for ON Semiconductor manufacturer:

Other Similar products are found below :

[1.5SMC82AT3G](#) [74LCX574WM](#) [FST3126MX](#) [MC78L08ACP](#) [MMBTA42](#) [FDD8424H_F085A](#) [NTZD3154NT1H](#) [KSA1015GRTA](#)
[BAT42XV2](#) [007851X](#) [702607H](#) [MC33079DG](#) [MC34072DR2G](#) [MC34151P](#) [MC78L08ACDG](#) [74VHC14MX](#) [74VHC541MTCX](#)
[FAN3111ESX](#) [FDMC86262P](#) [FDMD8530](#) [FEBFL7733A_L53U021A](#) [FEBFOD8333](#) [MM74HC138MX](#) [MMBZ5233B](#) [FOD3120SD](#)
[FPAB30BH60B](#) [FQP2N80](#) [1.5KE16AG](#) [MT9V115EBKSTCH-GEVB](#) [NB6L295MNGEVB](#) [NB7L1008MNGEVB](#) [NC7WZ126K8X](#)
[NCL30000LED2GEVB](#) [NCN9252MUGEVB](#) [NCP1075PSRGEVB](#) [NCV4274CDT33RKG](#) [NCV887100D1R2G](#) [NDT2955](#) [1N5339B](#)
[NSIC2030JBT3G](#) [NV890231MWTXGEVB](#) [CAT4101AEVB](#) [KA7818ETU](#) [S3JB](#) [2SC5569-TD-E](#) [FEBFL7734_L55L008A](#) [1V5KE39CA](#)
[FNB33060T](#) [AMIS30422DBGEBV](#) [AMIS3062XGEVK](#)