

MOSFET – Power, Single N-Channel, Logic Level, SO8FL

40 V, 0.7 mΩ, 349 A

NTMFS0D7N04XL

Features

- Low $R_{DS(on)}$ to Minimize Conduction Loss
- Low Q_{RR} with Soft Recovery to Minimize E_{RR} Loss and Voltage Spike
- Low Q_G and Capacitance to Minimize Driving and Switching Loss
- These Devices are Pb-Free, Halogen Free/BFR Free and are RoHS Compliant

Typical Applications

- High Switching Frequency DC-DC Conversion
- Synchronous Rectification

MAXIMUM RATINGS ($T_J = 25^\circ\text{C}$ unless otherwise stated)

| Parameter | Symbol | Value | Unit |
|--|----------------|---|------------------|
| Drain-to-Source Voltage | V_{DSS} | 40 | V |
| Gate-to-Source Voltage | DC V_{GS} | ± 20 | V |
| Continuous Drain Current (Note 2) | I_D | $T_C = 25^\circ\text{C}$ | 349 |
| | | $T_C = 100^\circ\text{C}$ | 247 |
| Power Dissipation (Note 2) | P_D | $T_C = 25^\circ\text{C}$ | 167 |
| | | $T_C = 100^\circ\text{C}$ | 83 |
| Pulsed Drain Current | I_{DM} | $T_C = 25^\circ\text{C}, t_p = 100 \mu\text{s}$ | 1667 |
| Pulsed Source Current (Body Diode) | | | I_{SM} |
| Operating Junction and Storage Temperature Range | T_J, T_{STG} | -55 to +175 | $^\circ\text{C}$ |
| Source Current (Body Diode) | I_S | 256 | A |
| Single Pulse Avalanche Energy ($I_{PK} = 97 \text{ A}$) (Note 3) | E_{AS} | 470 | mJ |
| Lead Temperature for Soldering Purposes (1/8" from case for 10 s) | T_L | 260 | $^\circ\text{C}$ |

Stresses exceeding those listed in the Maximum Ratings table may damage the device. If any of these limits are exceeded, device functionality should not be assumed, damage may occur and reliability may be affected.

1. Surface-mounted on FR4 board using 1 in² pad size, 1 oz Cu pad.
2. The entire application environment impacts the thermal resistance values shown, they are not constants and are only valid for the particular conditions noted.
3. E_{AS} of 470 mJ is based on started $T_J = 25^\circ\text{C}$, $I_{AS} = 97 \text{ A}$, $V_{DD} = 32 \text{ V}$, $V_{GS} = 10 \text{ V}$, 100% avalanche tested.
4. $R_{\theta JCT}$ Thermal Resistance - Junction to Case Top = 20 $^\circ\text{C}/\text{W}$.

| $V_{(BR)DSS}$ | $R_{DS(ON) MAX}$ | $I_D MAX$ |
|---------------|------------------|-----------|
| 40 V | 0.7 mΩ @ 10 V | 349 A |
| | 1.1 mΩ @ 4.5 V | |

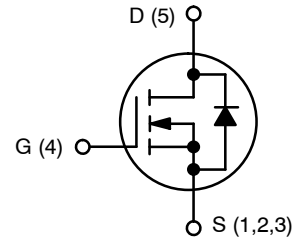

N-CHANNEL MOSFET

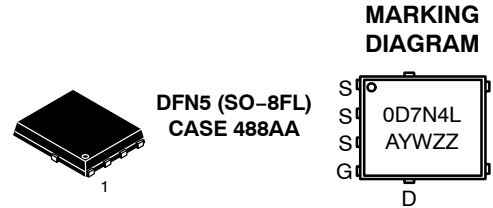

0D7N4L = Specific Device Code
 A = Assembly Location
 Y = Year
 W = Work Week
 ZZ = Lot Traceability

ORDERING INFORMATION

See detailed ordering, marking and shipping information on page 6 of this data sheet.

NTMFS0D7N04XL

THERMAL CHARACTERISTICS

| Parameter | Symbol | Value | Unit |
|---|-----------------|-------|------|
| Thermal Resistance, Junction-to-Case | $R_{\theta JC}$ | 0.9 | °C/W |
| Thermal Resistance, Junction-to-Ambient | $R_{\theta JA}$ | 38 | |

ELECTRICAL CHARACTERISTICS ($T_J = 25^\circ\text{C}$ unless otherwise specified)

| Parameter | Symbol | Test Conditions | Min | Typ | Max | Unit |
|-----------|--------|-----------------|-----|-----|-----|------|
|-----------|--------|-----------------|-----|-----|-----|------|

OFF CHARACTERISTICS

| | | | | | | |
|---|-----------------------------------|--|----|------|-----|---------------|
| Drain-to-Source Breakdown Voltage | $V_{(BR)DSS}$ | $V_{GS} = 0\text{ V}, I_D = 1\text{ mA}$ | 40 | | | V |
| Drain-to-Source Breakdown Voltage Temperature Coefficient | $\Delta V_{(BR)DSS} / \Delta T_J$ | $I_D = 1\text{ mA}$, Referenced to 25°C | | 16.6 | | mV/°C |
| Zero Gate Voltage Drain Current | I_{DSS} | $V_{DS} = 40\text{ V}, T_J = 25^\circ\text{C}$ | | | 10 | μA |
| | | $V_{DS} = 40\text{ V}, T_J = 125^\circ\text{C}$ | | | 100 | |
| Gate-to-Source Leakage Current | I_{GSS} | $V_{GS} = 20\text{ V}, V_{DS} = 0\text{ V}$ | | | 100 | nA |

ON CHARACTERISTICS

| | | | | | | |
|--|----------------------------------|--|-----|-------|-----|------------|
| Drain-to-Source On Resistance | $R_{DS(on)}$ | $V_{GS} = 10\text{ V}, I_D = 49\text{ A}$ | | 0.58 | 0.7 | m Ω |
| | | $V_{GS} = 6\text{ V}, I_D = 49\text{ A}$ | | 0.66 | 0.9 | |
| | | $V_{GS} = 4.5\text{ V}, I_D = 39\text{ A}$ | | 0.77 | 1.1 | |
| Gate Threshold Voltage | $V_{GS(TH)}$ | $V_{GS} = V_{DS}, I_D = 250\ \mu\text{A}$ | 1.3 | | 2.2 | V |
| Gate Threshold Voltage Temperature Coefficient | $\Delta V_{GS(TH)} / \Delta T_J$ | $V_{GS} = V_{DS}, I_D = 250\ \mu\text{A}$ | | -5.35 | | mV/°C |
| Forward Transconductance | g_{FS} | $V_{DS} = 5\text{ V}, I_D = 49\text{ A}$ | | 245 | | S |

CHARGES, CAPACITANCES & GATE RESISTANCE

| | | | | | | |
|------------------------------|--------------|--|--------------------|------|-----|----|
| Input Capacitance | C_{ISS} | $V_{GS} = 0\text{ V}, V_{DS} = 20\text{ V}, f = 1\text{ MHz}$ | | 7090 | | pF |
| Output Capacitance | C_{OSS} | | | 1860 | | |
| Reverse Transfer Capacitance | C_{RSS} | | | 40 | | |
| Output Charge | Q_{OSS} | $V_{GS} = 0\text{ V}, V_{DS} = 20\text{ V}$ | | 72 | | nC |
| Total Gate Charge | $Q_{G(TOT)}$ | $V_{GS} = 4.5\text{ V}, V_{DD} = 20\text{ V}; I_D = 49\text{ A}$ | | 42 | | |
| | | $V_{GS} = 6\text{ V}, V_{DD} = 20\text{ V}; I_D = 49\text{ A}$ | | 57 | | |
| | | $V_{GS} = 10\text{ V}, V_{DD} = 20\text{ V}; I_D = 49\text{ A}$ | | 96 | | |
| Threshold Gate Charge | $Q_{G(TH)}$ | $V_{GS} = 10\text{ V}, V_{DD} = 20\text{ V}; I_D = 49\text{ A}$ | | 11 | | |
| Gate-to-Source Charge | Q_{GS} | | | 20 | | |
| Gate-to-Drain Charge | Q_{GD} | | | 6 | | |
| Gate Plateau Voltage | V_{GP} | | | 2.89 | | V |
| Gate Resistance | R_G | | $f = 1\text{ MHz}$ | | 0.5 | |

SWITCHING CHARACTERISTICS

| | | | | | | |
|---------------------|--------------|--|--|----|--|----|
| Turn-On Delay Time | $t_{d(ON)}$ | Resistive Load, $V_{GS} = 0/10\text{ V}, V_{DD} = 20\text{ V},$ $I_D = 49\text{ A}, R_G = 2.5\ \Omega$ | | 25 | | ns |
| Rise Time | t_r | | | 7 | | |
| Turn-Off Delay Time | $t_{d(OFF)}$ | | | 64 | | |
| Fall Time | t_f | | | 5 | | |

NTMFS0D7N04XL

ELECTRICAL CHARACTERISTICS ($T_J = 25^\circ\text{C}$ unless otherwise specified)

| Parameter | Symbol | Test Conditions | Min | Typ | Max | Unit |
|--|----------|---|-----|------|-----|------|
| SOURCE-TO-DRAIN DIODE CHARACTERISTICS | | | | | | |
| Forward Diode Voltage | V_{SD} | $V_{GS} = 0\text{ V}, I_S = 49\text{ A}, T_J = 25^\circ\text{C}$ | | 0.8 | 1.2 | V |
| | | $V_{GS} = 0\text{ V}, I_S = 49\text{ A}, T_J = 125^\circ\text{C}$ | | 0.65 | | |
| Reverse Recovery Time | t_{RR} | $V_{GS} = 0\text{ V}, di/dt = 300\text{ A}/\mu\text{s},$ $I_S = 49\text{ A}, V_{DD} = 20\text{ V}$ | | 39 | | ns |
| Charge Time | t_a | | | 21 | | |
| Discharge Time | t_b | | | 18 | | |
| Reverse Recovery Charge | Q_{RR} | | | 87 | | |

Product parametric performance is indicated in the Electrical Characteristics for the listed test conditions, unless otherwise noted. Product performance may not be indicated by the Electrical Characteristics if operated under different conditions.

NTMFS0D7N04XL

TYPICAL CHARACTERISTICS

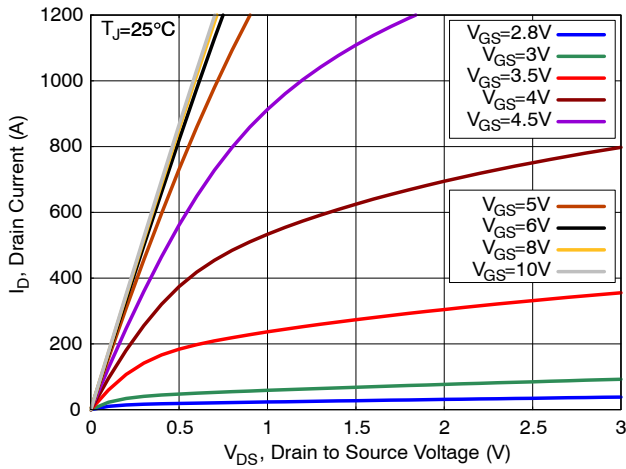

Figure 1. On-Region Characteristics

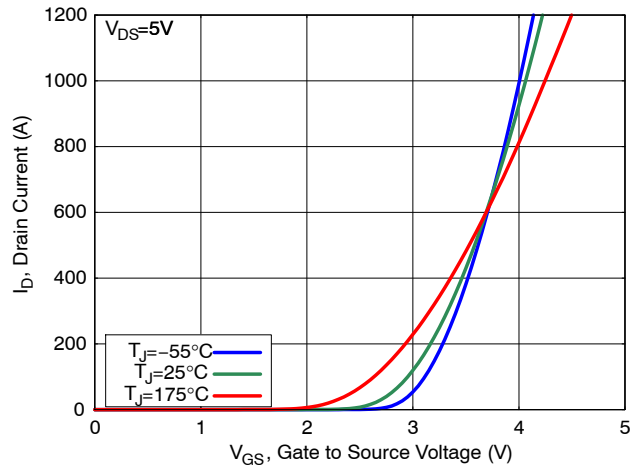

Figure 2. Transfer Characteristics

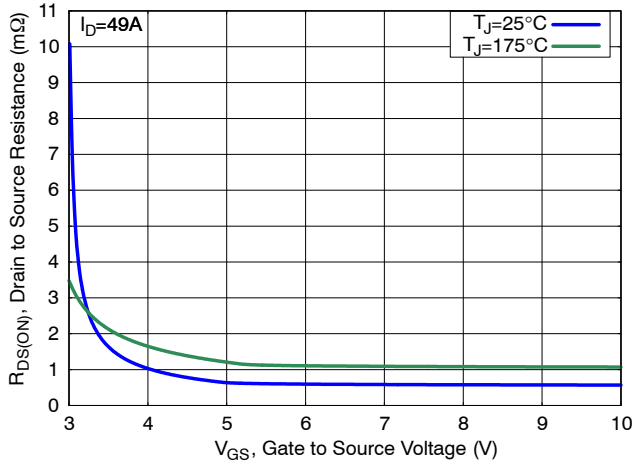

Figure 3. On-Resistance vs. Gate Voltage

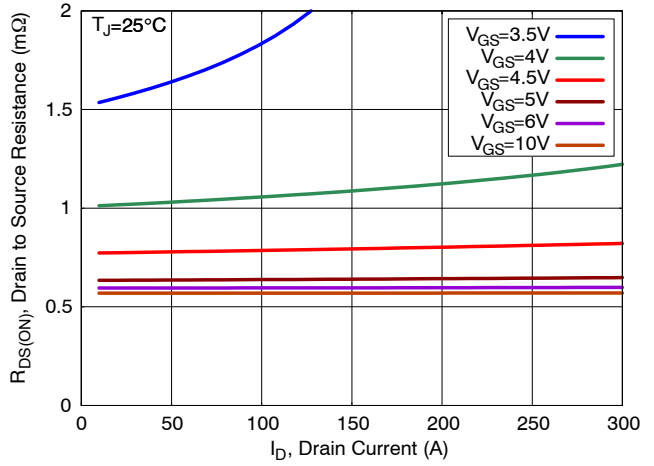

Figure 4. On-Resistance vs. Drain Current

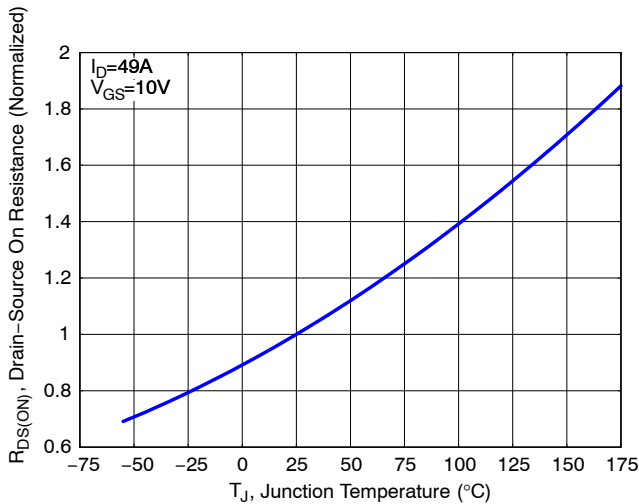

Figure 5. Normalized ON Resistance vs. Junction Temperature

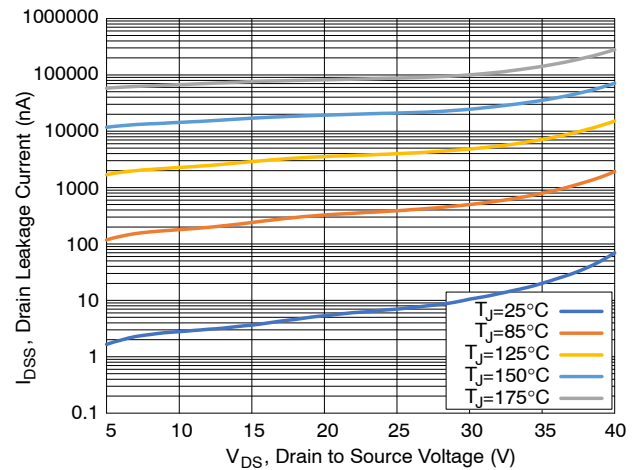

Figure 6. Drain Leakage Current vs. Drain Voltage

NTMFS0D7N04XL

TYPICAL CHARACTERISTICS (CONTINUED)

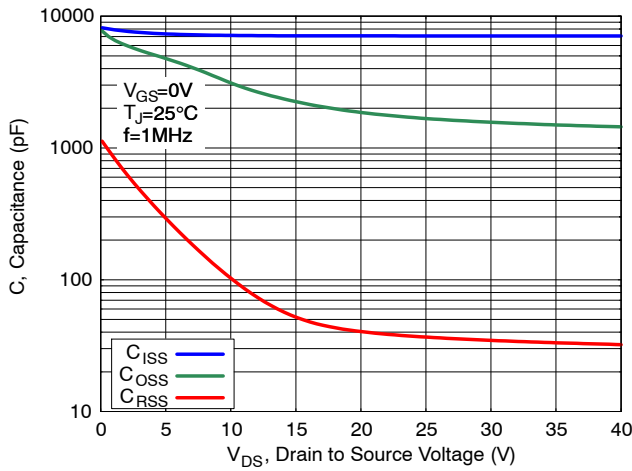

Figure 7. Capacitance Characteristics

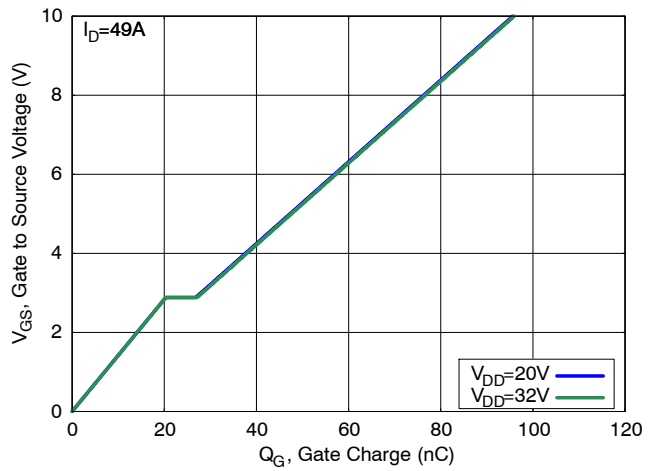

Figure 8. Gate Charge Characteristics

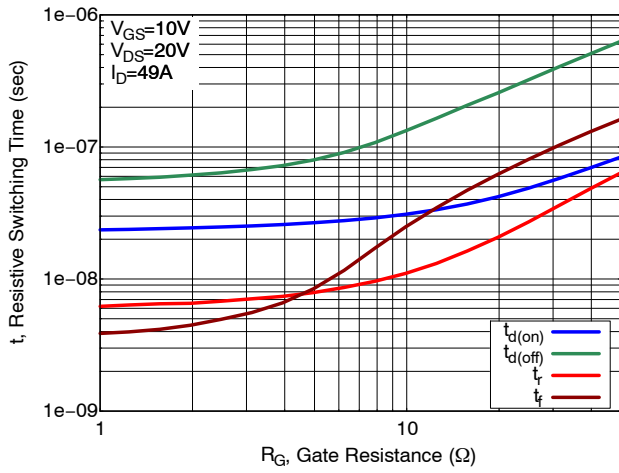

Figure 9. Resistive Switching Time Variation vs. Gate Resistance

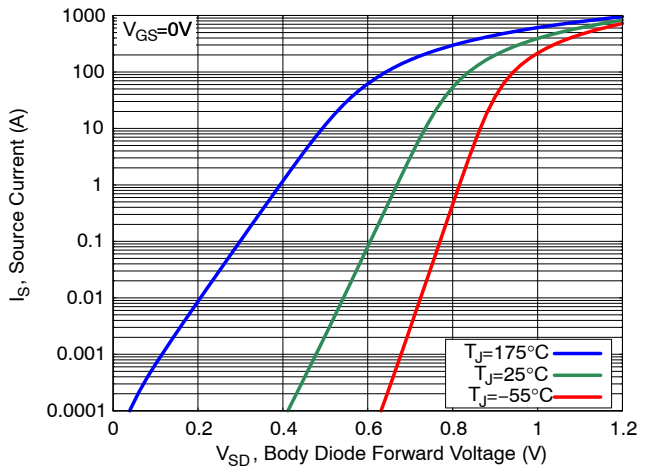

Figure 10. Diode Forward Characteristics

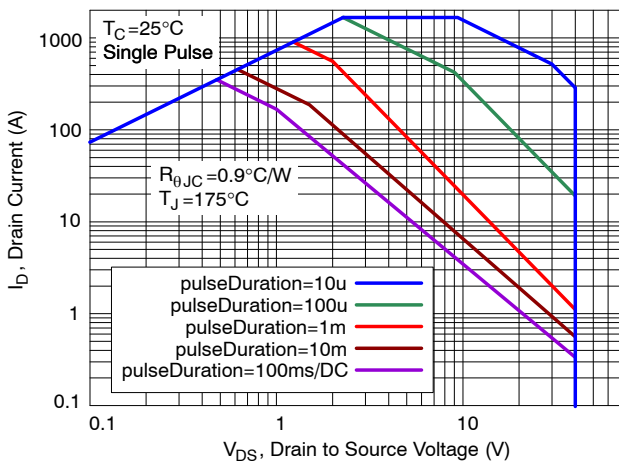

Figure 11. Safe Operating Area (SOA)

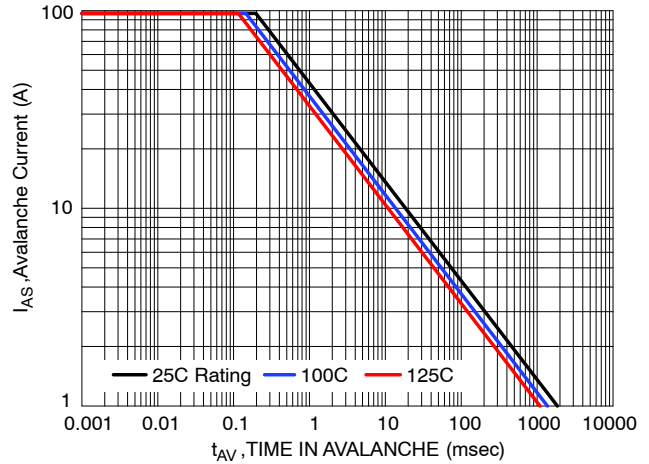

Figure 12. Avalanche Current vs. Pulse Time (UIS)

NTMFS0D7N04XL

TYPICAL CHARACTERISTICS (CONTINUED)

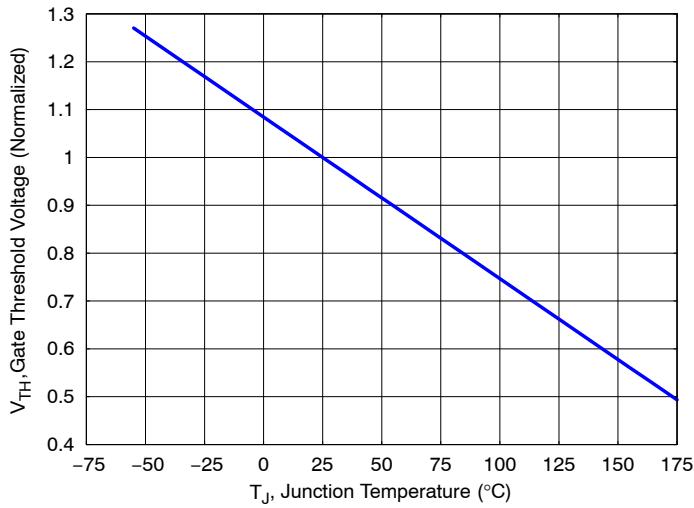

Figure 13. Gate Threshold Voltage vs. Junction Temperature

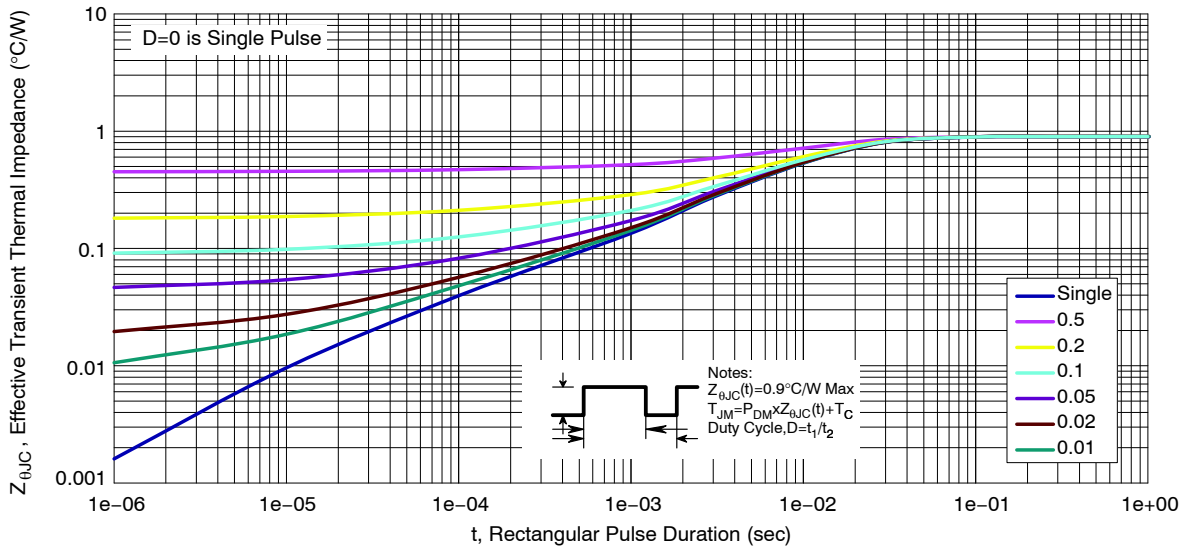

Figure 14. Thermal Characteristics

DEVICE ORDERING INFORMATION

| Device | Marking | Package | Shipping [†] |
|------------------|---------|-------------------|-----------------------|
| NTMFS0D7N04XLT1G | 0D7N4L | DFN5 (Pb-Free) | 1500 / Tape & Reel |

[†]For information on tape and reel specifications, including part orientation and tape sizes, please refer to our Tape and Reel Packaging Specifications Brochure, BRD8011/D.

MECHANICAL CASE OUTLINE

PACKAGE DIMENSIONS



1
SCALE 2:1

DFN5 5x6, 1.27P
(SO-8FL)
CASE 488AA
ISSUE N

DATE 25 JUN 2018



NOTES:

1. DIMENSIONING AND TOLERANCING PER ASME Y14.5M, 1994.
2. CONTROLLING DIMENSION: MILLIMETER.
3. DIMENSION D1 AND E1 DO NOT INCLUDE MOLD FLASH PROTRUSIONS OR GATE BURRS.

| DIM | MILLIMETERS | | |
|-----|-------------|-------|------|
| | MIN | NOM | MAX |
| A | 0.90 | 1.00 | 1.10 |
| A1 | 0.00 | --- | 0.05 |
| b | 0.33 | 0.41 | 0.51 |
| c | 0.23 | 0.28 | 0.33 |
| D | 5.00 | 5.15 | 5.30 |
| D1 | 4.70 | 4.90 | 5.10 |
| D2 | 3.80 | 4.00 | 4.20 |
| E | 6.00 | 6.15 | 6.30 |
| E1 | 5.70 | 5.90 | 6.10 |
| E2 | 3.45 | 3.65 | 3.85 |
| e | 1.27 BSC | | |
| G | 0.51 | 0.575 | 0.71 |
| K | 1.20 | 1.35 | 1.50 |
| L | 0.51 | 0.575 | 0.71 |
| L1 | 0.125 REF | | |
| M | 3.00 | 3.40 | 3.80 |
| θ | 0° | --- | 12° |

GENERIC MARKING DIAGRAM*



- XXXXXX = Specific Device Code
- A = Assembly Location
- Y = Year
- W = Work Week
- ZZ = Lot Traceability

*This information is generic. Please refer to device data sheet for actual part marking. Pb-Free indicator, "G" or microdot "•", may or may not be present. Some products may not follow the Generic Marking.

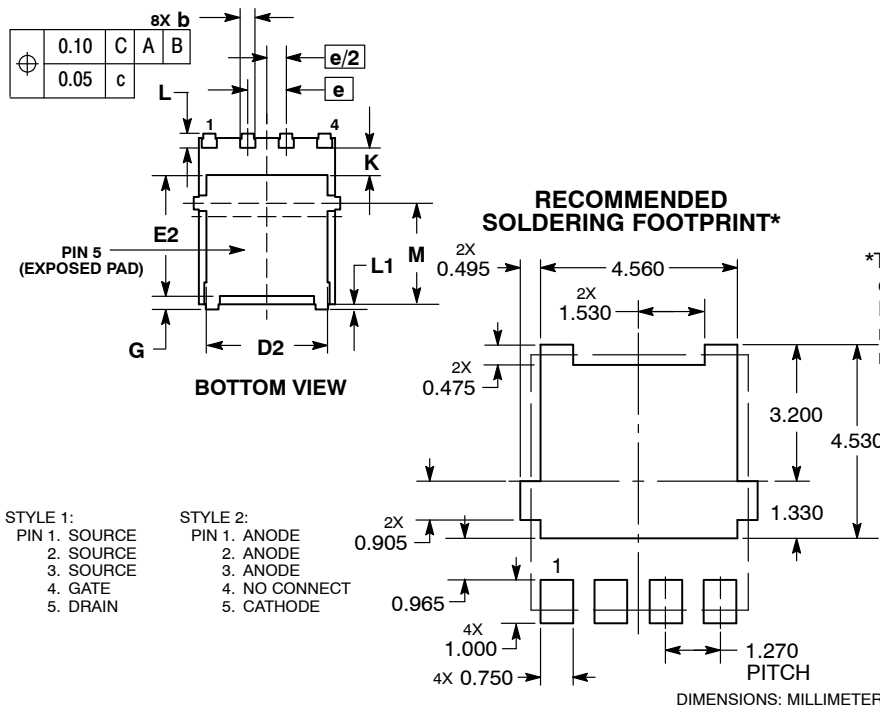

- STYLE 1:
PIN 1. SOURCE
2. SOURCE
3. SOURCE
4. GATE
5. DRAIN
- STYLE 2:
PIN 1. ANODE
2. ANODE
3. ANODE
4. NO CONNECT
5. CATHODE

DIMENSIONS: MILLIMETERS

*For additional information on our Pb-Free strategy and soldering details, please download the ON Semiconductor Soldering and Mounting Techniques Reference Manual, SOLDERRM/D.

| | | |
|------------------|--------------------------|--|
| DOCUMENT NUMBER: | 98AON14036D | Electronic versions are uncontrolled except when accessed directly from the Document Repository. Printed versions are uncontrolled except when stamped "CONTROLLED COPY" in red. |
| DESCRIPTION: | DFN5 5x6, 1.27P (SO-8FL) | PAGE 1 OF 1 |

onsemi and ONSEMI are trademarks of Semiconductor Components Industries, LLC dba onsemi or its subsidiaries in the United States and/or other countries. onsemi reserves the right to make changes without further notice to any products herein. onsemi makes no warranty, representation or guarantee regarding the suitability of its products for any particular purpose, nor does onsemi assume any liability arising out of the application or use of any product or circuit, and specifically disclaims any and all liability, including without limitation special, consequential or incidental damages. onsemi does not convey any license under its patent rights nor the rights of others.

onsemi, **Onsemi**, and other names, marks, and brands are registered and/or common law trademarks of Semiconductor Components Industries, LLC dba "**onsemi**" or its affiliates and/or subsidiaries in the United States and/or other countries. **onsemi** owns the rights to a number of patents, trademarks, copyrights, trade secrets, and other intellectual property. A listing of **onsemi**'s product/patent coverage may be accessed at www.onsemi.com/site/pdf/Patent-Marking.pdf. **onsemi** reserves the right to make changes at any time to any products or information herein, without notice. The information herein is provided "as-is" and **onsemi** makes no warranty, representation or guarantee regarding the accuracy of the information, product features, availability, functionality, or suitability of its products for any particular purpose, nor does **onsemi** assume any liability arising out of the application or use of any product or circuit, and specifically disclaims any and all liability, including without limitation special, consequential or incidental damages. Buyer is responsible for its products and applications using **onsemi** products, including compliance with all laws, regulations and safety requirements or standards, regardless of any support or applications information provided by **onsemi**. "Typical" parameters which may be provided in **onsemi** data sheets and/or specifications can and do vary in different applications and actual performance may vary over time. All operating parameters, including "Typicals" must be validated for each customer application by customer's technical experts. **onsemi** does not convey any license under any of its intellectual property rights nor the rights of others. **onsemi** products are not designed, intended, or authorized for use as a critical component in life support systems or any FDA Class 3 medical devices or medical devices with a same or similar classification in a foreign jurisdiction or any devices intended for implantation in the human body. Should Buyer purchase or use **onsemi** products for any such unintended or unauthorized application, Buyer shall indemnify and hold **onsemi** and its officers, employees, subsidiaries, affiliates, and distributors harmless against all claims, costs, damages, and expenses, and reasonable attorney fees arising out of, directly or indirectly, any claim of personal injury or death associated with such unintended or unauthorized use, even if such claim alleges that **onsemi** was negligent regarding the design or manufacture of the part. **onsemi** is an Equal Opportunity/Affirmative Action Employer. This literature is subject to all applicable copyright laws and is not for resale in any manner.

ADDITIONAL INFORMATION

TECHNICAL PUBLICATIONS:

Technical Library: www.onsemi.com/design/resources/technical-documentation
onsemi Website: www.onsemi.com

ONLINE SUPPORT: www.onsemi.com/support

For additional information, please contact your local Sales Representative at www.onsemi.com/support/sales

X-ON Electronics

Largest Supplier of Electrical and Electronic Components

Click to view similar products for ON Semiconductor manufacturer:

Other Similar products are found below :

[041950FB](#) [0W888-002-XTP](#) [100307QCX](#) [12A02CH-TL-E](#) [15025-512-XTD](#) [15C01C-TB-E](#) [15C01M-TL-E](#) [15C01SS-TL-E](#) [15C02CH-TL-E](#)
[15C02MH-TL-E](#) [15GN03CA-TB-E](#) [15GN03MA-TL-E](#) [1.5KE120ARL4](#) [1.5KE18ARL4G](#) [1.5KE250A](#) [1.5KE27ARL4G](#) [1.5KE39ARL4G](#)
[1.5KE47ARL4G](#) [1.5SMC20AT3](#) [1.5SMC24AT3](#) [1.5SMC27AT3](#) [1.5SMC39AT3](#) [1.5SMC47AT3](#) [1.5SMC68AT3](#) [1.5SMC82AT3](#)
[1HN04CH-TL-W](#) [1HP04CH-TL-W](#) [1N3064](#) [1N3070TR](#) [1N3595](#) [1N3595TR](#) [1N4001G](#) [1N4001RLG](#) [1N4002G](#) [1N4002RLG](#) [1N4003G](#)
[1N4003RLG](#) [1N4004G](#) [1N4004RLG](#) [1N4005G](#) [1N4005RLG](#) [1N4005TR](#) [1N4006FFG](#) [1N4006G](#) [1N4006RLG](#) [1N4007FFG](#) [1N4007G](#)
[1N4007RLG](#) [1N4148](#) [1N4148_T26A](#)