

MOSFET - Power, Single N-Channel, SO8FL

40 V, 1.3 mΩ, 195 A

NTMFS1D3N04XM

Features

- Low $R_{DS(on)}$ to Minimize Conduction Losses
- Low Capacitance to Minimize Driver Losses
- Small Footprint (5 x 6 mm) with Compact Design
- These Devices are Pb-Free, Halogen Free/BFR Free and are RoHS Compliant

Applications

- Motor Drive
- Battery Protection
- ORing

MAXIMUM RATINGS ($T_J = 25^\circ\text{C}$ unless otherwise stated)

Parameter	Symbol	Value	Unit
Drain-to-Source Voltage	V_{DSS}	40	V
Gate-to-Source Voltage	DC V_{GS}	± 20	V
Continuous Drain Current	$T_C = 25^\circ\text{C}$	I_D	195
		$T_C = 100^\circ\text{C}$	138
Power Dissipation	$T_C = 25^\circ\text{C}$	P_D	90
Continuous Drain Current $R_{\theta JA}$	$T_A = 25^\circ\text{C}$	I_{DA}	40
	$T_A = 100^\circ\text{C}$		28
Pulsed Drain Current	$T_C = 25^\circ\text{C}, t_p = 10 \mu\text{s}$	I_{DM}	1175
Operating Junction and Storage Temperature Range	T_J, T_{STG}	-55 to +175	$^\circ\text{C}$
Source Current (Body Diode)	I_S	74.5	A
Single Pulse Avalanche Energy ($I_{PK} = 11.1 \text{ A}$)	E_{AS}	306	mJ
Lead Temperature for Soldering Purposes (1/8" from case for 10 s)	T_L	260	$^\circ\text{C}$

Stresses exceeding those listed in the Maximum Ratings table may damage the device. If any of these limits are exceeded, device functionality should not be assumed, damage may occur and reliability may be affected.

$V_{(BR)DSS}$	$R_{DS(on)} \text{ MAX}$	$I_D \text{ MAX}$
40 V	1.3 mΩ @ $V_{GS} = 10 \text{ V}$	195 A

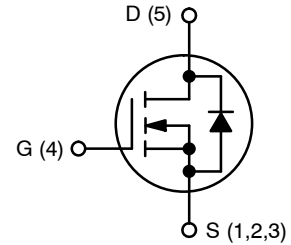

N-CHANNEL MOSFET

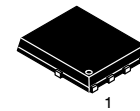

SO-8FL
CASE 488AA
(DFN5)

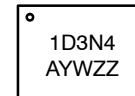

1D3N4 = Specific Device Code
A = Assembly Location
Y = Year
W = Work Week
ZZ = Assembly Lot Code

ORDERING INFORMATION

See detailed ordering, marking and shipping information in the package dimensions section on page 5 of this data sheet.

NTMFS1D3N04XM

THERMAL CHARACTERISTICS

Parameter	Symbol	Value	Unit
Thermal Resistance, Junction-to-Case (Note 2)	$R_{\theta JC}$	1.67	°C/W
Thermal Resistance, Junction-to-Ambient (Notes 1, 2)	$R_{\theta JA}$	40.1	

- Surface mounted on FR4 board using 650 mm², 2 oz Cu pad.
- The entire application environment impacts the thermal resistance values shown, they are not constants and are only valid for the particular conditions noted.

ELECTRICAL CHARACTERISTICS ($T_J = 25^\circ\text{C}$ unless otherwise specified)

Parameter	Symbol	Test Condition	Min	Typ	Max	Unit
-----------	--------	----------------	-----	-----	-----	------

OFF CHARACTERISTICS

Drain-to-Source Breakdown Voltage	$V_{(BR)DSS}$	$V_{GS} = 0\text{ V}, I_D = 1\text{ mA}, T_J = 25^\circ\text{C}$	40			V
Drain-to-Source Breakdown Voltage Temperature Coefficient	$\Delta V_{(BR)DSS} / \Delta T_J$	$I_D = 1\text{ mA}$, Referenced to 25°C		15		mV/°C
Zero Gate Voltage Drain Current	I_{DSS}	$V_{DS} = 40\text{ V}, T_J = 25^\circ\text{C}$			10	μA
		$V_{DS} = 40\text{ V}, T_J = 125^\circ\text{C}$			100	
Gate-to-Source Leakage Current	I_{GSS}	$V_{GS} = 20\text{ V}, V_{DS} = 0\text{ V}$			100	nA

ON CHARACTERISTICS

Drain-to-Source On Resistance	$R_{DS(on)}$	$V_{GS} = 10\text{ V}, I_D = 20\text{ A}, T_J = 25^\circ\text{C}$		1.17	1.3	mΩ
Gate Threshold Voltage	$V_{GS(TH)}$	$V_{GS} = V_{DS}, I_D = 100\text{ }\mu\text{A}, T_J = 25^\circ\text{C}$	2.5	3.0	3.5	V
Gate Threshold Voltage Temperature Coefficient	$\Delta V_{GS(TH)} / \Delta T_J$	$V_{GS} = V_{DS}, I_D = 100\text{ }\mu\text{A}$		-7.23		mV/°C
Forward Trans-conductance	g_{FS}	$V_{DS} = 5\text{ V}, I_D = 20\text{ A}$		105		S

CHARGES, CAPACITANCES & GATE RESISTANCE

Input Capacitance	C_{ISS}	$V_{GS} = 0\text{ V}, V_{DS} = 20\text{ V}, f = 1\text{ MHz}$		2473		pF
Output Capacitance	C_{OSS}			1763		
Reverse Transfer Capacitance	C_{RSS}			37.3		
Total Gate Charge	$Q_{G(TOT)}$	$V_{GS} = 10\text{ V}, V_{DD} = 20\text{ V}; I_D = 50\text{ A}$		38.5		nC
Threshold Gate Charge	$Q_{G(TH)}$			7.27		
Gate-to-Source Charge	Q_{GS}			11.3		
Gate-to-Drain Charge	Q_{GD}			7.07		
Gate Resistance	R_G		$f = 1\text{ MHz}$		1.21	

SWITCHING CHARACTERISTICS

Turn-On Delay Time	$t_{d(ON)}$	Resistive Load, $V_{GS} = 0/10\text{ V}, V_{DD} = 20\text{ V},$ $I_D = 50\text{ A}, R_G = 0\text{ }\Omega$		20		ns
Rise Time	t_r			6.27		
Turn-Off Delay Time	$t_{d(OFF)}$			29.2		
Fall Time	t_f			5.47		

SOURCE-TO-DRAIN DIODE CHARACTERISTICS

Forward Diode Voltage	V_{SD}	$V_{GS} = 0\text{ V}, I_S = 20\text{ A}, T_J = 25^\circ\text{C}$		0.79	1.2	V
		$V_{GS} = 0\text{ V}, I_S = 20\text{ A}, T_J = 125^\circ\text{C}$		0.63		
Reverse Recovery Time	t_{RR}	$V_{GS} = 0\text{ V}, I_S = 50\text{ A},$ $di/dt = 100\text{ A}/\mu\text{s}, V_{DD} = 20\text{ V}$		47.1		ns
Charge Time	t_a			23.4		
Discharge Time	t_b			23.7		
Reverse Recovery Charge	Q_{RR}			53.7		

Product parametric performance is indicated in the Electrical Characteristics for the listed test conditions, unless otherwise noted. Product performance may not be indicated by the Electrical Characteristics if operated under different conditions.

NTMFS1D3N04XM

TYPICAL CHARACTERISTICS

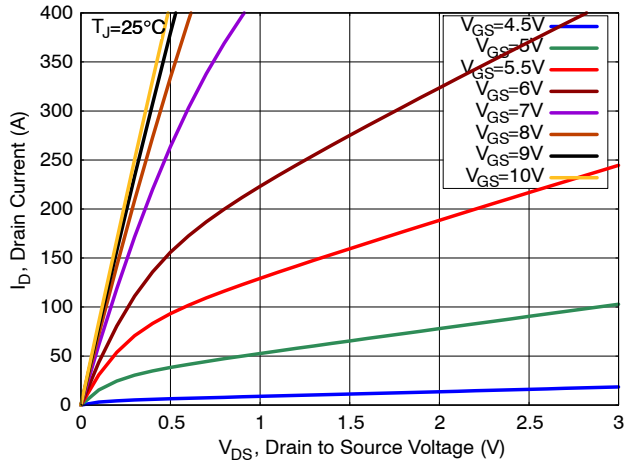

Figure 1. On-Region Characteristics

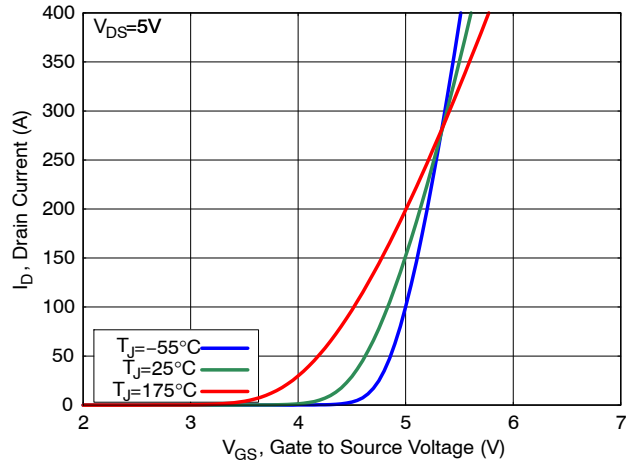

Figure 2. Transfer Characteristics

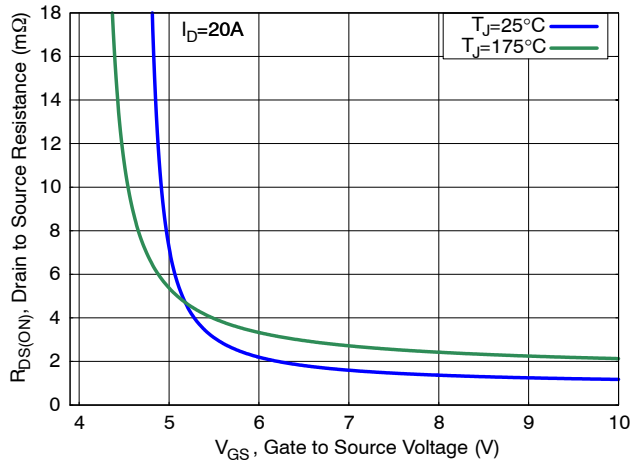

Figure 3. On-Resistance vs. V_{GS}

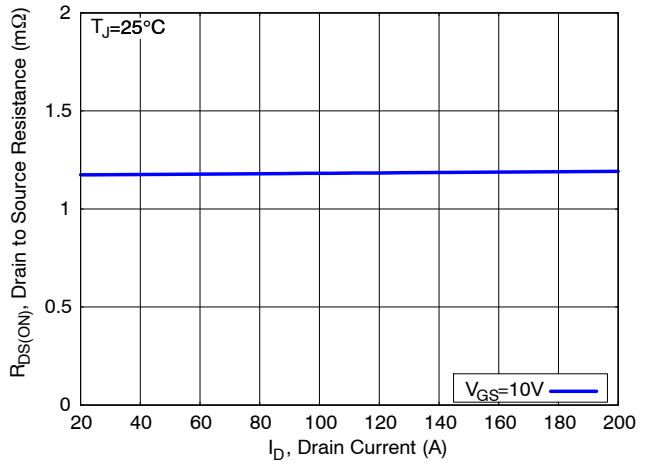

Figure 4. On-Resistance vs. Drain Current and Gate Voltage

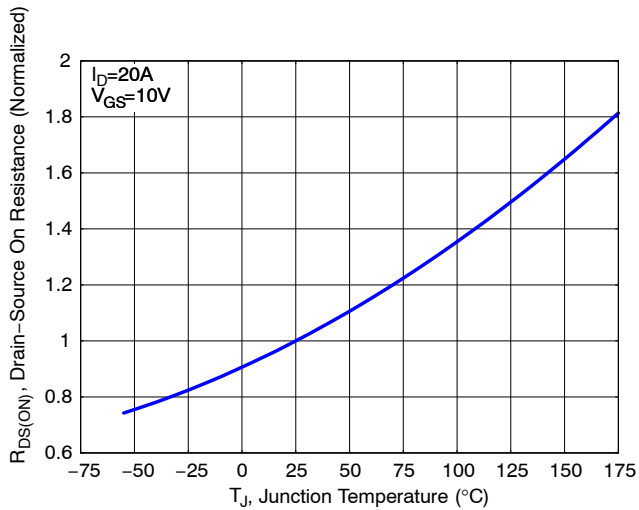

Figure 5. On-Resistance Variation with Temperature

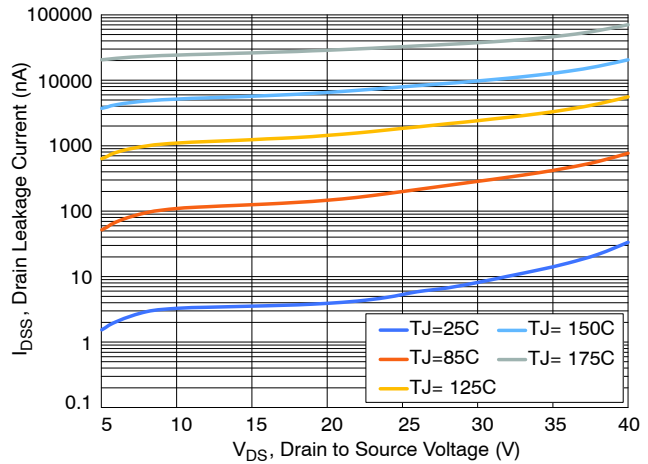

Figure 6. Drain-to-Source Leakage Current vs. Voltage

NTMFS1D3N04XM

TYPICAL CHARACTERISTICS

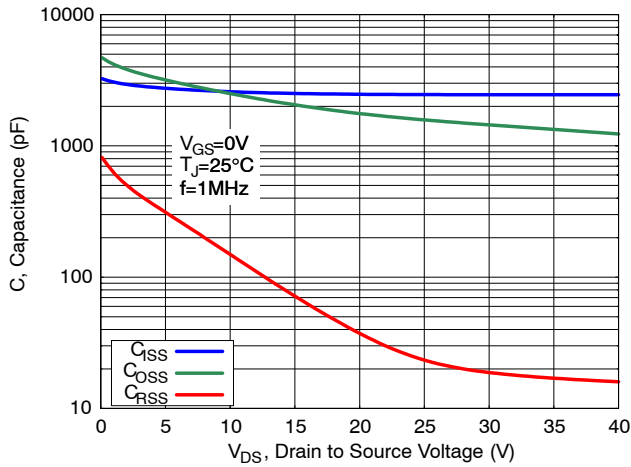

Figure 7. Capacitance Characteristics

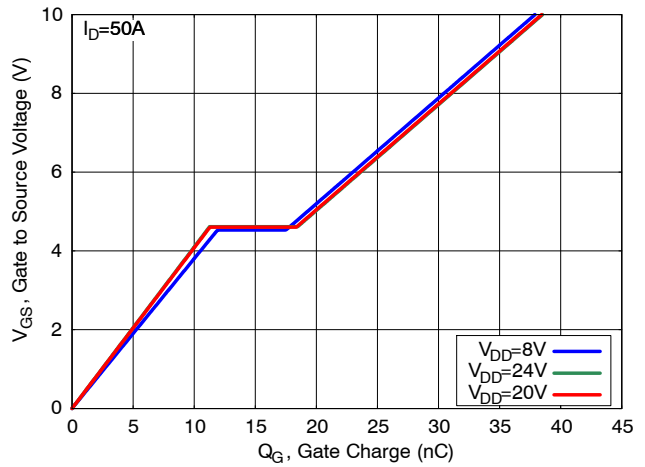

Figure 8. Gate-to-Source Voltage vs. Total Charge

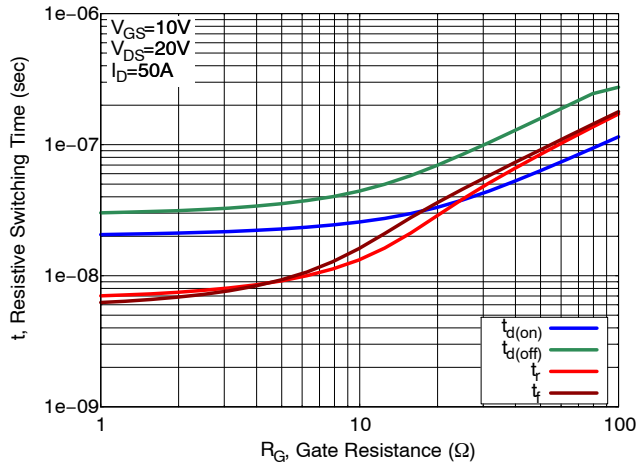

Figure 9. Resistive Switching Time Variation vs. Gate Resistance

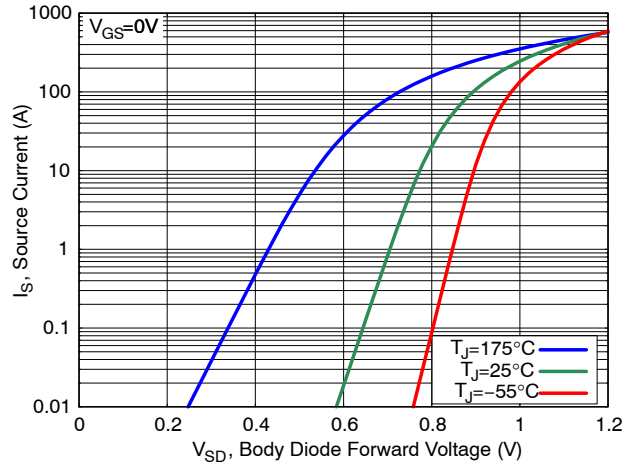

Figure 10. Diode Forward Voltage vs. Current

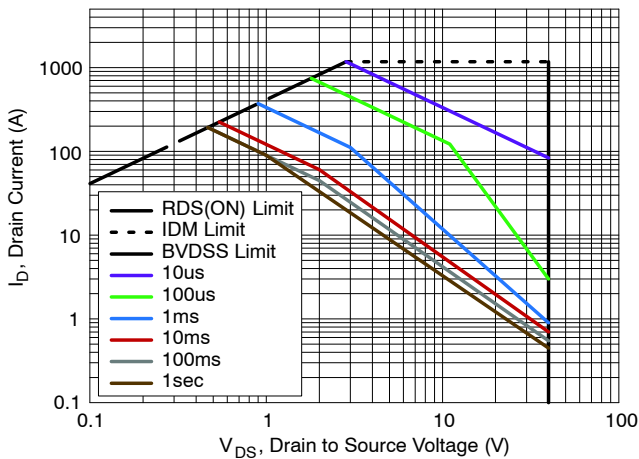

Figure 11. Safe Operating Area (SOA)

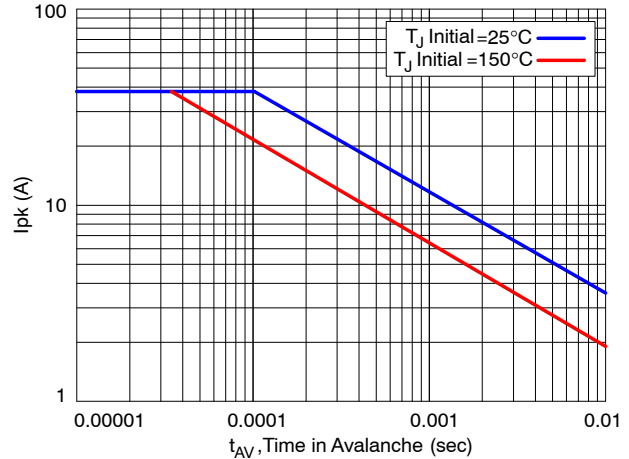

Figure 12. Avalanche Current vs Pulse Time (UIS)

NTMFS1D3N04XM

TYPICAL CHARACTERISTICS

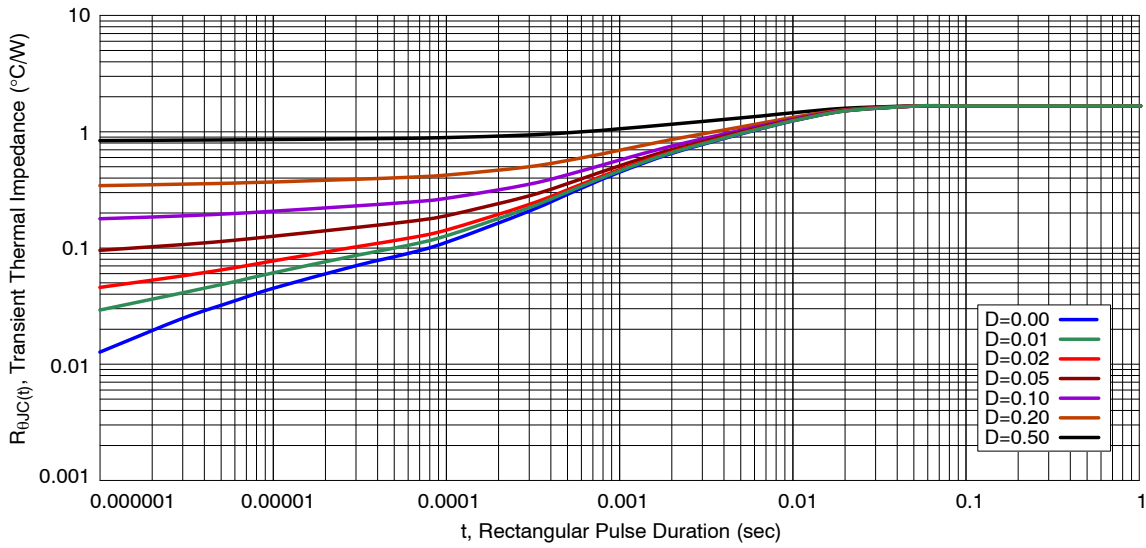

Figure 13. Transient Thermal Response

ORDERING INFORMATION

Device	Marking	Package	Shipping [†]
NTMFS1D3N04XMT1G	1D3N4	SO-8FL (DFN5) (Pb-Free)	1500 / Tape & Reel

[†]For information on tape and reel specifications, including part orientation and tape sizes, please refer to our Tape and Reel Packaging Specifications Brochure, BRD8011/D.

MECHANICAL CASE OUTLINE

PACKAGE DIMENSIONS



1
SCALE 2:1

DFN5 5x6, 1.27P
(SO-8FL)
CASE 488AA
ISSUE N

DATE 25 JUN 2018

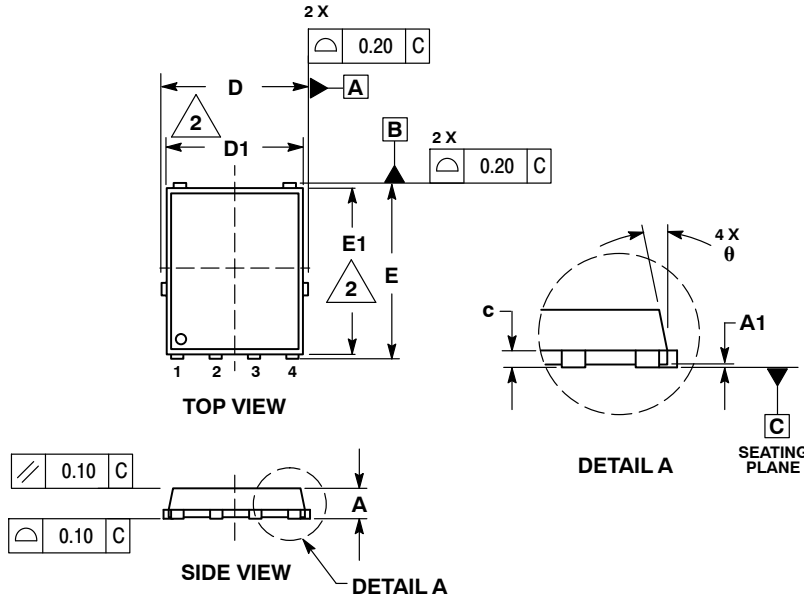

NOTES:

1. DIMENSIONING AND TOLERANCING PER ASME Y14.5M, 1994.
2. CONTROLLING DIMENSION: MILLIMETER.
3. DIMENSION D1 AND E1 DO NOT INCLUDE MOLD FLASH PROTRUSIONS OR GATE BURRS.

DIM	MILLIMETERS		
	MIN	NOM	MAX
A	0.90	1.00	1.10
A1	0.00	---	0.05
b	0.33	0.41	0.51
c	0.23	0.28	0.33
D	5.00	5.15	5.30
D1	4.70	4.90	5.10
D2	3.80	4.00	4.20
E	6.00	6.15	6.30
E1	5.70	5.90	6.10
E2	3.45	3.65	3.85
e	1.27 BSC		
G	0.51	0.575	0.71
K	1.20	1.35	1.50
L	0.51	0.575	0.71
L1	0.125 REF		
M	3.00	3.40	3.80
θ	0°	---	12°

GENERIC MARKING DIAGRAM*



- XXXXXX = Specific Device Code
- A = Assembly Location
- Y = Year
- W = Work Week
- ZZ = Lot Traceability

*This information is generic. Please refer to device data sheet for actual part marking. Pb-Free indicator, "G" or microdot "•", may or may not be present. Some products may not follow the Generic Marking.

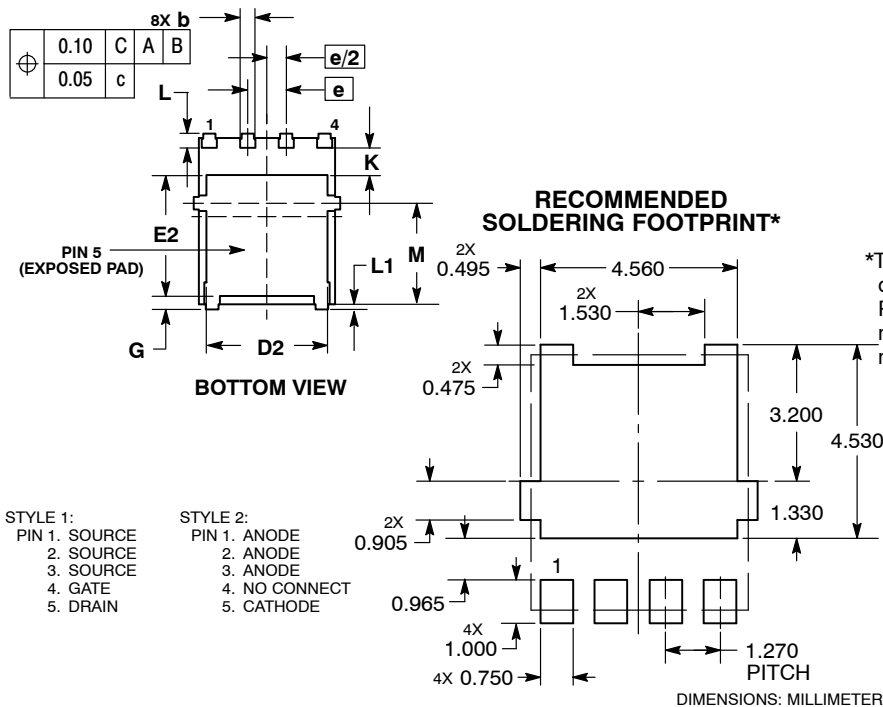

- STYLE 1:
PIN 1. SOURCE
2. SOURCE
3. SOURCE
4. GATE
5. DRAIN
- STYLE 2:
PIN 1. ANODE
2. ANODE
3. ANODE
4. NO CONNECT
5. CATHODE

*For additional information on our Pb-Free strategy and soldering details, please download the ON Semiconductor Soldering and Mounting Techniques Reference Manual, SOLDERRM/D.

DOCUMENT NUMBER:	98AON14036D	Electronic versions are uncontrolled except when accessed directly from the Document Repository. Printed versions are uncontrolled except when stamped "CONTROLLED COPY" in red.
DESCRIPTION:	DFN5 5x6, 1.27P (SO-8FL)	PAGE 1 OF 1

onsemi and ONSEMI are trademarks of Semiconductor Components Industries, LLC dba onsemi or its subsidiaries in the United States and/or other countries. onsemi reserves the right to make changes without further notice to any products herein. onsemi makes no warranty, representation or guarantee regarding the suitability of its products for any particular purpose, nor does onsemi assume any liability arising out of the application or use of any product or circuit, and specifically disclaims any and all liability, including without limitation special, consequential or incidental damages. onsemi does not convey any license under its patent rights nor the rights of others.

onsemi, **Onsemi**, and other names, marks, and brands are registered and/or common law trademarks of Semiconductor Components Industries, LLC dba "**onsemi**" or its affiliates and/or subsidiaries in the United States and/or other countries. **onsemi** owns the rights to a number of patents, trademarks, copyrights, trade secrets, and other intellectual property. A listing of **onsemi**'s product/patent coverage may be accessed at www.onsemi.com/site/pdf/Patent-Marking.pdf. **onsemi** reserves the right to make changes at any time to any products or information herein, without notice. The information herein is provided "as-is" and **onsemi** makes no warranty, representation or guarantee regarding the accuracy of the information, product features, availability, functionality, or suitability of its products for any particular purpose, nor does **onsemi** assume any liability arising out of the application or use of any product or circuit, and specifically disclaims any and all liability, including without limitation special, consequential or incidental damages. Buyer is responsible for its products and applications using **onsemi** products, including compliance with all laws, regulations and safety requirements or standards, regardless of any support or applications information provided by **onsemi**. "Typical" parameters which may be provided in **onsemi** data sheets and/or specifications can and do vary in different applications and actual performance may vary over time. All operating parameters, including "Typicals" must be validated for each customer application by customer's technical experts. **onsemi** does not convey any license under any of its intellectual property rights nor the rights of others. **onsemi** products are not designed, intended, or authorized for use as a critical component in life support systems or any FDA Class 3 medical devices or medical devices with a same or similar classification in a foreign jurisdiction or any devices intended for implantation in the human body. Should Buyer purchase or use **onsemi** products for any such unintended or unauthorized application, Buyer shall indemnify and hold **onsemi** and its officers, employees, subsidiaries, affiliates, and distributors harmless against all claims, costs, damages, and expenses, and reasonable attorney fees arising out of, directly or indirectly, any claim of personal injury or death associated with such unintended or unauthorized use, even if such claim alleges that **onsemi** was negligent regarding the design or manufacture of the part. **onsemi** is an Equal Opportunity/Affirmative Action Employer. This literature is subject to all applicable copyright laws and is not for resale in any manner.

ADDITIONAL INFORMATION

TECHNICAL PUBLICATIONS:

Technical Library: www.onsemi.com/design/resources/technical-documentation
onsemi Website: www.onsemi.com

ONLINE SUPPORT: www.onsemi.com/support

For additional information, please contact your local Sales Representative at www.onsemi.com/support/sales

X-ON Electronics

Largest Supplier of Electrical and Electronic Components

Click to view similar products for [ON Semiconductor](#) manufacturer:

Other Similar products are found below :

[041950FB](#) [0W888-002-XTP](#) [100307QCX](#) [12A02CH-TL-E](#) [15025-512-XTD](#) [15C01C-TB-E](#) [15C01M-TL-E](#) [15C01SS-TL-E](#) [15C02CH-TL-E](#)
[15C02MH-TL-E](#) [15GN03CA-TB-E](#) [15GN03MA-TL-E](#) [1.5KE120ARL4](#) [1.5KE18ARL4G](#) [1.5KE250A](#) [1.5KE27ARL4G](#) [1.5KE39ARL4G](#)
[1.5KE47ARL4G](#) [1.5SMC20AT3](#) [1.5SMC24AT3](#) [1.5SMC27AT3](#) [1.5SMC39AT3](#) [1.5SMC47AT3](#) [1.5SMC68AT3](#) [1.5SMC82AT3](#)
[1HN04CH-TL-W](#) [1HP04CH-TL-W](#) [1N3064](#) [1N3070TR](#) [1N3595](#) [1N3595TR](#) [1N4001G](#) [1N4001RLG](#) [1N4002G](#) [1N4002RLG](#) [1N4003G](#)
[1N4003RLG](#) [1N4004G](#) [1N4004RLG](#) [1N4005G](#) [1N4005RLG](#) [1N4005TR](#) [1N4006FFG](#) [1N4006G](#) [1N4006RLG](#) [1N4007FFG](#) [1N4007G](#)
[1N4007RLG](#) [1N4148](#) [1N4148_T26A](#)