

MOSFET - Power, Single P-Channel, Small Signal

-20 V, -127 mA



ON Semiconductor®

www.onsemi.com

NTNS2K1P021Z

Features

- Low Profile Ultra Small Package, XDFN3 (0.62 x 0.42 x 0.4 mm) for Extremely Space-Constrained Applications
- -1.5 V Gate Drive
- These Devices are Pb-Free, Halogen Free/BFR Free and are RoHS Compliant

Applications

- Small Signal Load Switch
- High Speed Interfacing
- Level Shift

MAXIMUM RATINGS (T_J = 25°C unless otherwise stated)

| Parameter | | | Symbol | Value | Unit |
|---|------------------------|-----------------------|-----------------------------------|------------|------|
| Drain-to-Source Voltage | | | V _{DSS} | 20 | V |
| Gate-to-Source Voltage | | | V _{GS} | ±8 | V |
| Continuous Drain Current (Note 1) | Steady State | T _A = 25°C | I _D | -127 | mA |
| | | T _A = 85°C | | -91 | |
| | t ≤ 5 s | T _A = 25°C | | -146 | |
| Power Dissipation (Note 1) | Steady State | T _A = 25°C | P _D | 125 | mW |
| | t ≤ 5 s | | | 166 | |
| Pulsed Drain Current | t _p = 10 μs | | I _{DM} | -488 | mA |
| Operating Junction and Storage Temperature Range | | | T _J , T _{STG} | -55 to 150 | °C |
| Source Current (Body Diode) (Note 2) | | | I _S | 200 | mA |
| Lead Temperature for Soldering Purposes (1/8" from case for 10 s) | | | T _L | 260 | °C |

Stresses exceeding those listed in the Maximum Ratings table may damage the device. If any of these limits are exceeded, device functionality should not be assumed, damage may occur and reliability may be affected.

1. Surface-mounted on FR4 board using the minimum recommended pad size, or 2 mm², 1 oz Cu.
2. Pulse Test: pulse width ≤ 300 μs, duty cycle ≤ 2%

| V _{(BR)DSS} | R _{DS(on)} MAX | I _D Max |
|----------------------|-------------------------|--------------------|
| -20 V | 5.0 Ω @ -4.5 V | -127 mA |
| | 7.0 Ω @ -1.8 V | |
| | 20 Ω @ -1.2 V | |

P-CHANNEL MOSFET

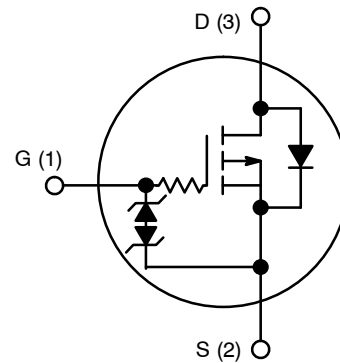

MARKING DIAGRAM



XDFN3
CASE 711BH

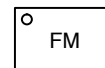

1

F = Specific Device Code
M = Date Code

ORDERING INFORMATION

| Device | Package | Shipping† |
|-----------------|-----------------|--------------------|
| NTNS2K1P021ZTCG | XDFN3 (Pb-Free) | 8000 / Tape & Reel |

†For information on tape and reel specifications, including part orientation and tape sizes, please refer to our Tape and Reel Packaging Specification Brochure, BRD8011/D.

NTNS2K1P021Z

THERMAL RESISTANCE RATINGS

| Parameter | Symbol | Max | Unit |
|---|-----------------|-----|------|
| Junction-to-Ambient – Steady State (Note 3) | $R_{\theta JA}$ | 998 | °C/W |
| Junction-to-Ambient – $t \leq 5$ s (Note 3) | $R_{\theta JA}$ | 751 | |

3. Surface-mounted on FR4 board using the minimum recommended pad size, or 2 mm², 1 oz Cu.

ELECTRICAL CHARACTERISTICS ($T_J = 25^\circ\text{C}$ unless otherwise stated)

| Parameter | Symbol | Test Condition | Min | Typ | Max | Unit |
|-----------|--------|----------------|-----|-----|-----|------|
|-----------|--------|----------------|-----|-----|-----|------|

OFF CHARACTERISTICS

| | | | | | | |
|-----------------------------------|---------------|--|-----|--|-----------|----|
| Drain-to-Source Breakdown Voltage | $V_{(BR)DSS}$ | $V_{GS} = 0$ V, $I_D = -250$ μ A | -20 | | | V |
| Zero Gate Voltage Drain Current | I_{DSS} | $V_{GS} = 0$ V, $V_{DS} = -5$ V, $T_J = 25^\circ\text{C}$ | | | -50 | nA |
| Zero Gate Voltage Drain Current | I_{DSS} | $V_{GS} = 0$ V, $V_{DS} = -16$ V, $T_J = 25^\circ\text{C}$ | | | -100 | nA |
| Gate-to-Source Leakage Current | I_{GSS} | $V_{DS} = 0$ V, $V_{GS} = \pm 5$ V | | | ± 100 | nA |

ON CHARACTERISTICS (Note 4)

| | | | | | | |
|-------------------------------|--------------|--|------|------|------|----------|
| Gate Threshold Voltage | $V_{GS(TH)}$ | $V_{GS} = V_{DS}$, $I_D = -250$ μ A | -0.4 | | -1.0 | V |
| Drain-to-Source On Resistance | $R_{DS(on)}$ | $V_{GS} = -4.5$ V, $I_D = -100$ mA | | 2.1 | 5.0 | Ω |
| | | $V_{GS} = -1.8$ V, $I_D = -20$ mA | | 3.6 | 7.0 | |
| | | $V_{GS} = -1.2$ V, $I_D = -10$ mA | | 7.3 | 20 | |
| Forward Transconductance | g_{FS} | $V_{DS} = -5$ V, $I_D = -125$ mA | | 0.35 | | S |
| Source-Drain Diode Voltage | V_{SD} | $V_{GS} = 0$ V, $I_S = -10$ mA | | -0.6 | -1.0 | V |

CHARGES & CAPACITANCES

| | | | | | | |
|------------------------------|-----------|--|--|------|--|----|
| Input Capacitance | C_{ISS} | $V_{GS} = 0$ V, freq = 1 MHz, $V_{DS} = -15$ V | | 12.8 | | pF |
| Output Capacitance | C_{OSS} | | | 2.8 | | |
| Reverse Transfer Capacitance | C_{RSS} | | | 2.0 | | |

SWITCHING CHARACTERISTICS, $V_{GS} = 4.5$ V (Note 4)

| | | | | | | |
|---------------------|--------------|--|--|-----|--|----|
| Turn-On Delay Time | $t_{d(ON)}$ | $V_{GS} = -4.5$ V, $V_{DD} = -15$ V, $I_D = 200$ mA, $R_G = 2$ Ω | | 37 | | ns |
| Rise Time | t_r | | | 71 | | |
| Turn-Off Delay Time | $t_{d(OFF)}$ | | | 280 | | |
| Fall Time | t_f | | | 171 | | |

4. Switching characteristics are independent of operating junction temperatures.

TYPICAL CHARACTERISTICS

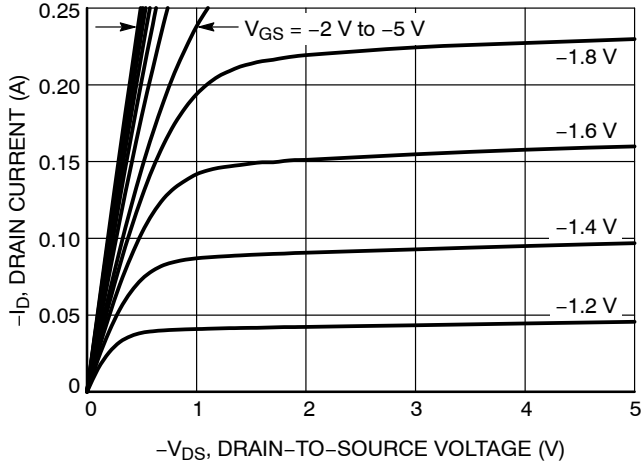

Figure 1. On-Region Characteristics

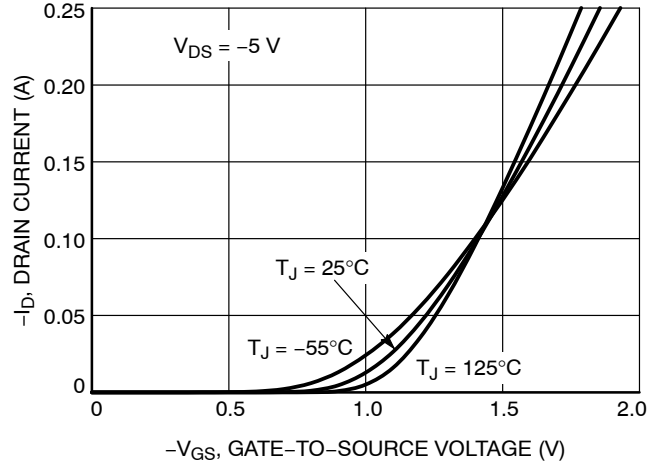

Figure 2. Transfer Characteristics

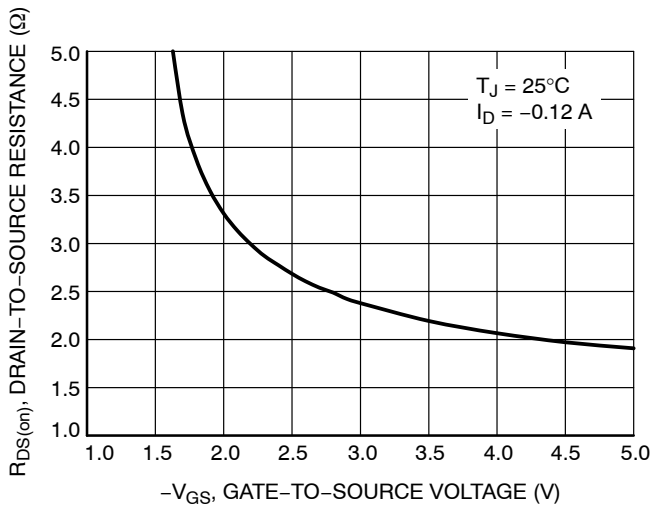

Figure 3. On-Resistance vs. Gate-to-Source Voltage

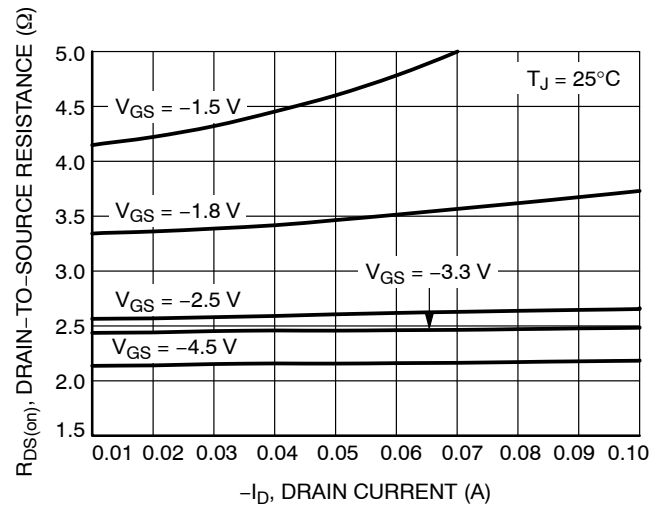

Figure 4. On-Resistance vs. Drain Current and Gate Voltage

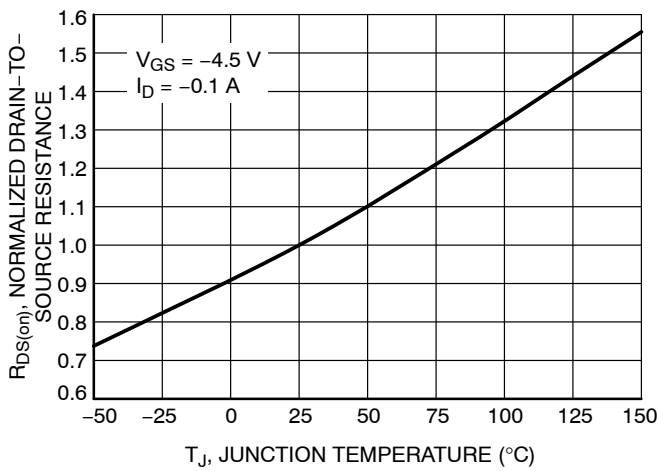

Figure 5. On-Resistance Variation with Temperature

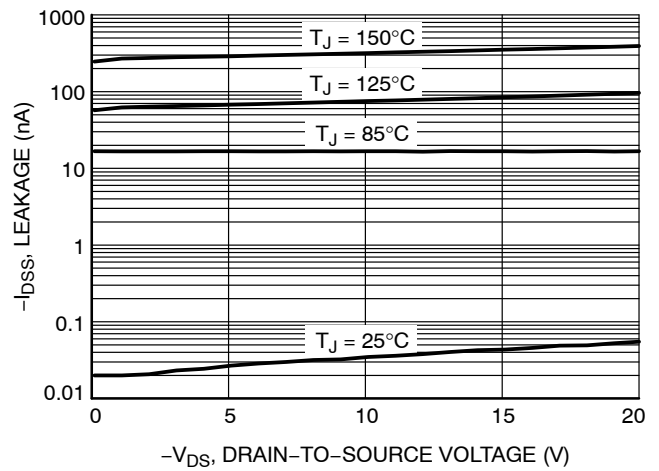

Figure 6. Drain-to-Source Leakage Current vs. Voltage

NTNS2K1P021Z

TYPICAL CHARACTERISTICS

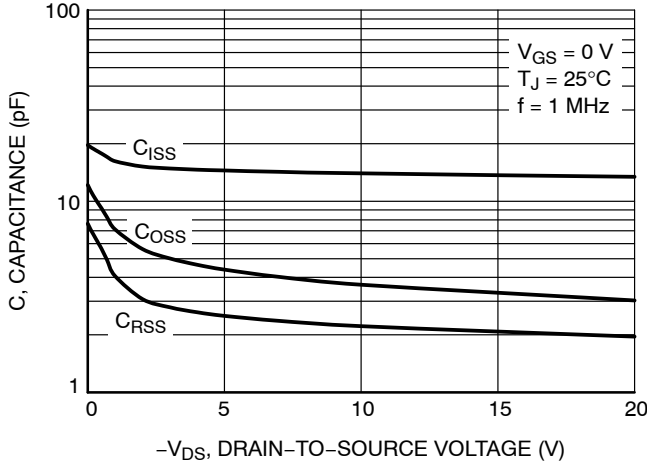

Figure 7. Capacitance Variation

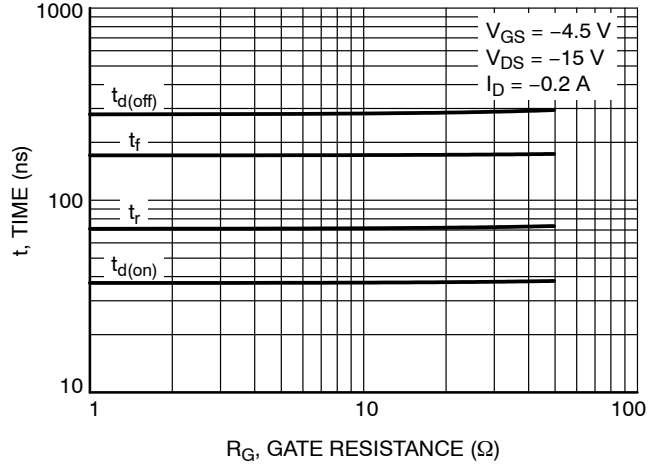

Figure 8. Resistive Switching Time Variation vs. Gate Resistance

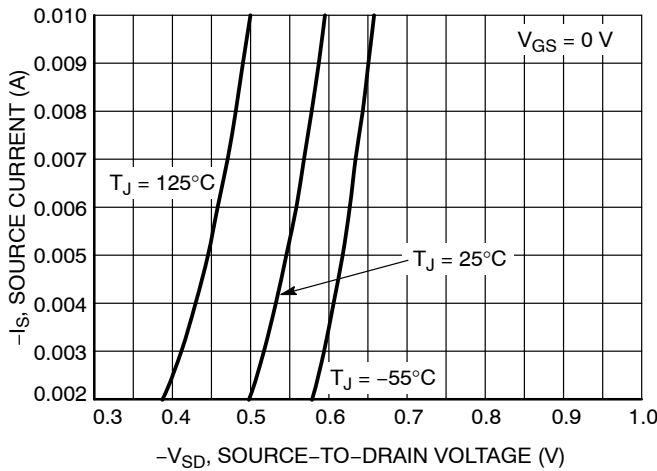

Figure 9. Diode Forward Voltage vs. Current

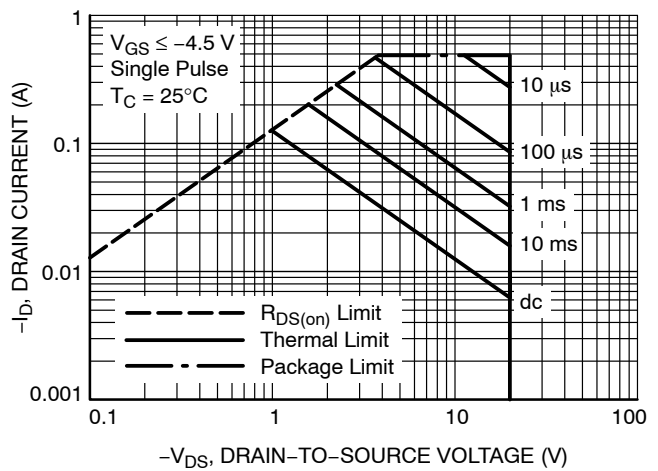

Figure 10. Maximum Rated Forward Biased Safe Operating Area

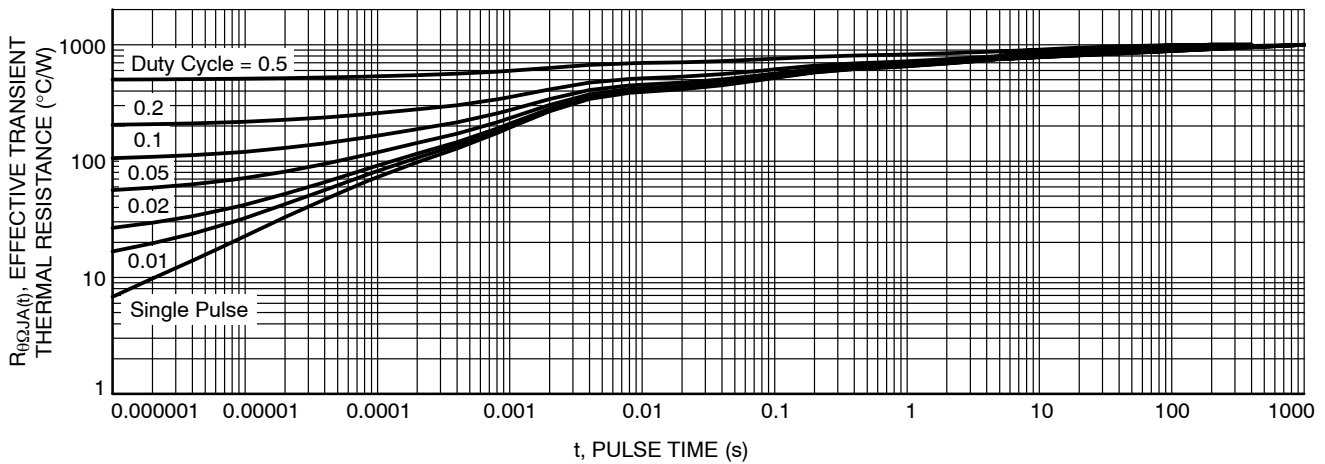
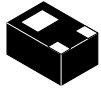

Figure 11. Thermal Response



SCALE 8:1

XDFN3 0.42x0.62, 0.3P
CASE 711BH
ISSUE A

DATE 29 APR 2018

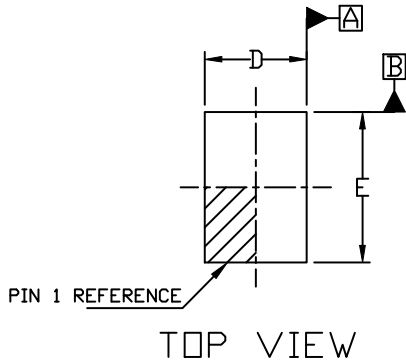

TOP VIEW

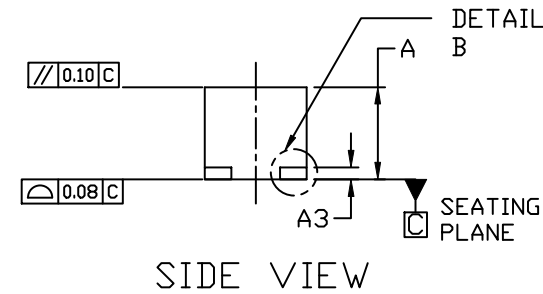

SIDE VIEW

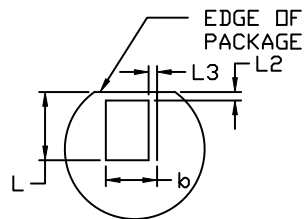

DETAIL A
OPTIONAL
CONSTRUCTION

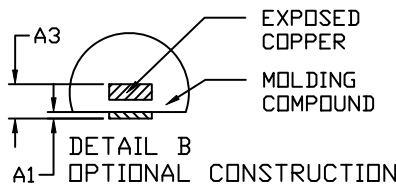

DETAIL B
OPTIONAL CONSTRUCTION

| DIM | MILLIMETERS | | |
|-----|-------------|------|------|
| | MIN. | NOM. | MAX. |
| A | 0.33 | 0.38 | 0.43 |
| A1 | --- | --- | 0.07 |
| A3 | 0.13 REF | | |
| b | 0.05 | 0.11 | 0.17 |
| b1 | 0.20 | 0.25 | 0.30 |
| D | 0.32 | 0.42 | 0.52 |
| E | 0.52 | 0.62 | 0.72 |
| e | 0.30 BSC | | |
| e1 | 0.38 BSC | | |
| L | 0.09 | 0.15 | 0.21 |
| L1 | 0.15 | 0.20 | 0.25 |
| L2 | --- | --- | 0.03 |
| L3 | --- | --- | 0.03 |
| k | 0.20 REF | | |

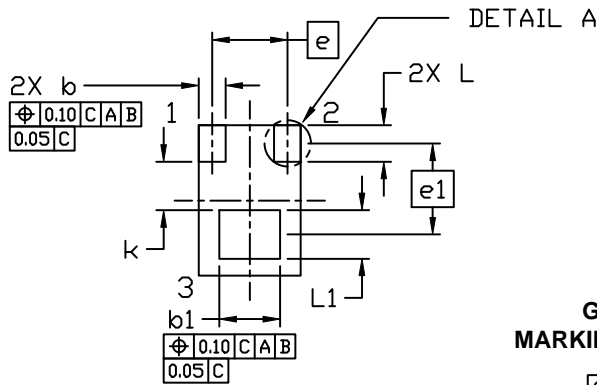

BOTTOM VIEW

GENERIC MARKING DIAGRAM*

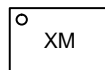

X = Specific Device Code
M = Date Code

*This information is generic. Please refer to device data sheet for actual part marking. Pb-Free indicator, "G", may or not be present. Some products may not follow the Generic Marking.

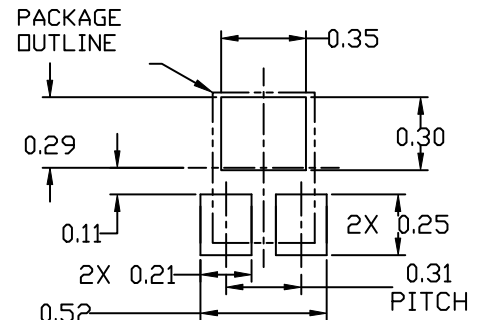

RECOMMENDED
MOUNTING FOOTPRINT

| | | |
|-------------------------|------------------------------|--|
| DOCUMENT NUMBER: | 98AON64946G | Electronic versions are uncontrolled except when accessed directly from the Document Repository. Printed versions are uncontrolled except when stamped "CONTROLLED COPY" in red. |
| DESCRIPTION: | XDFN3 0.42x0.62, 0.3P | PAGE 1 OF 1 |

ON Semiconductor and are trademarks of Semiconductor Components Industries, LLC dba ON Semiconductor or its subsidiaries in the United States and/or other countries. ON Semiconductor reserves the right to make changes without further notice to any products herein. ON Semiconductor makes no warranty, representation or guarantee regarding the suitability of its products for any particular purpose, nor does ON Semiconductor assume any liability arising out of the application or use of any product or circuit, and specifically disclaims any and all liability, including without limitation special, consequential or incidental damages. ON Semiconductor does not convey any license under its patent rights nor the rights of others.

onsemi, **Onsemi**, and other names, marks, and brands are registered and/or common law trademarks of Semiconductor Components Industries, LLC dba "**onsemi**" or its affiliates and/or subsidiaries in the United States and/or other countries. **onsemi** owns the rights to a number of patents, trademarks, copyrights, trade secrets, and other intellectual property. A listing of **onsemi**'s product/patent coverage may be accessed at www.onsemi.com/site/pdf/Patent-Marking.pdf. **onsemi** reserves the right to make changes at any time to any products or information herein, without notice. The information herein is provided "as-is" and **onsemi** makes no warranty, representation or guarantee regarding the accuracy of the information, product features, availability, functionality, or suitability of its products for any particular purpose, nor does **onsemi** assume any liability arising out of the application or use of any product or circuit, and specifically disclaims any and all liability, including without limitation special, consequential or incidental damages. Buyer is responsible for its products and applications using **onsemi** products, including compliance with all laws, regulations and safety requirements or standards, regardless of any support or applications information provided by **onsemi**. "Typical" parameters which may be provided in **onsemi** data sheets and/or specifications can and do vary in different applications and actual performance may vary over time. All operating parameters, including "Typicals" must be validated for each customer application by customer's technical experts. **onsemi** does not convey any license under any of its intellectual property rights nor the rights of others. **onsemi** products are not designed, intended, or authorized for use as a critical component in life support systems or any FDA Class 3 medical devices or medical devices with a same or similar classification in a foreign jurisdiction or any devices intended for implantation in the human body. Should Buyer purchase or use **onsemi** products for any such unintended or unauthorized application, Buyer shall indemnify and hold **onsemi** and its officers, employees, subsidiaries, affiliates, and distributors harmless against all claims, costs, damages, and expenses, and reasonable attorney fees arising out of, directly or indirectly, any claim of personal injury or death associated with such unintended or unauthorized use, even if such claim alleges that **onsemi** was negligent regarding the design or manufacture of the part. **onsemi** is an Equal Opportunity/Affirmative Action Employer. This literature is subject to all applicable copyright laws and is not for resale in any manner.

PUBLICATION ORDERING INFORMATION

LITERATURE FULFILLMENT:

Email Requests to: orderlit@onsemi.com

onsemi Website: www.onsemi.com

TECHNICAL SUPPORT

North American Technical Support:

Voice Mail: 1 800-282-9855 Toll Free USA/Canada

Phone: 011 421 33 790 2910

Europe, Middle East and Africa Technical Support:

Phone: 00421 33 790 2910

For additional information, please contact your local Sales Representative

X-ON Electronics

Largest Supplier of Electrical and Electronic Components

Click to view similar products for [MOSFET](#) category:

Click to view products by [ON Semiconductor](#) manufacturer:

Other Similar products are found below :

[614233C](#) [648584F](#) [IRFD120](#) [JANTX2N5237](#) [FCA20N60_F109](#) [FDZ595PZ](#) [2SK2545\(Q,T\)](#) [405094E](#) [423220D](#) [TPCC8103,L1Q\(CM](#)
[MIC4420CM-TR](#) [VN1206L](#) [SBVS138LT1G](#) [614234A](#) [715780A](#) [NTNS3166NZT5G](#) [SSM6J414TU,LF\(T](#) [751625C](#) [BUK954R8-60E](#)
[NTE6400](#) [SQJ402EP-T1-GE3](#) [2SK2614\(Te16L1,Q\)](#) [2N7002KW-FAI](#) [DMN1017UCP3-7](#) [EFC2J004NUZTDG](#) [ECH8691-TL-W](#)
[FCAB21350L1](#) [P85W28HP2F-7071](#) [DMN1053UCP4-7](#) [NTE221](#) [NTE222](#) [NTE2384](#) [NTE2903](#) [NTE2941](#) [NTE2945](#) [NTE2946](#) [NTE2960](#)
[NTE2967](#) [NTE2969](#) [NTE2976](#) [NTE455](#) [NTE6400A](#) [NTE2910](#) [NTE2916](#) [NTE2956](#) [NTE2911](#) [DMN2080UCB4-7](#) [TK10A80W,S4X\(S](#)
[SSM6P69NU,LF](#) [DMP22D4UFO-7B](#)