

ON Semiconductor

Is Now

onsemi™

To learn more about onsemi™, please visit our website at
www.onsemi.com

onsemi and **onsemi** and other names, marks, and brands are registered and/or common law trademarks of Semiconductor Components Industries, LLC dba "**onsemi**" or its affiliates and/or subsidiaries in the United States and/or other countries. **onsemi** owns the rights to a number of patents, trademarks, copyrights, trade secrets, and other intellectual property. A listing of **onsemi** product/patent coverage may be accessed at www.onsemi.com/site/pdf/Patent-Marking.pdf. **onsemi** reserves the right to make changes at any time to any products or information herein, without notice. The information herein is provided "as-is" and **onsemi** makes no warranty, representation or guarantee regarding the accuracy of the information, product features, availability, functionality, or suitability of its products for any particular purpose, nor does **onsemi** assume any liability arising out of the application or use of any product or circuit, and specifically disclaims any and all liability, including without limitation special, consequential or incidental damages. Buyer is responsible for its products and applications using **onsemi** products, including compliance with all laws, regulations and safety requirements or standards, regardless of any support or applications information provided by **onsemi**. "Typical" parameters which may be provided in **onsemi** data sheets and/or specifications can and do vary in different applications and actual performance may vary over time. All operating parameters, including "Typicals" must be validated for each customer application by customer's technical experts. **onsemi** does not convey any license under any of its intellectual property rights nor the rights of others. **onsemi** products are not designed, intended, or authorized for use as a critical component in life support systems or any FDA Class 3 medical devices or medical devices with a same or similar classification in a foreign jurisdiction or any devices intended for implantation in the human body. Should Buyer purchase or use **onsemi** products for any such unintended or unauthorized application, Buyer shall indemnify and hold **onsemi** and its officers, employees, subsidiaries, affiliates, and distributors harmless against all claims, costs, damages, and expenses, and reasonable attorney fees arising out of, directly or indirectly, any claim of personal injury or death associated with such unintended or unauthorized use, even if such claim alleges that **onsemi** was negligent regarding the design or manufacture of the part. **onsemi** is an Equal Opportunity/Affirmative Action Employer. This literature is subject to all applicable copyright laws and is not for resale in any manner. Other names and brands may be claimed as the property of others.



ON Semiconductor®

2N3906 / MMBT3906 / PZT3906 PNP General-Purpose Amplifier

Description

This device is designed for general-purpose amplifier and switching applications at collector currents of 10 mA to 100 mA.

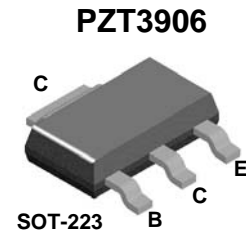
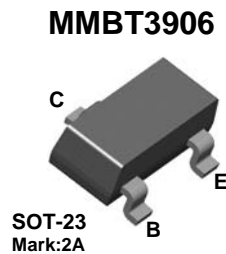
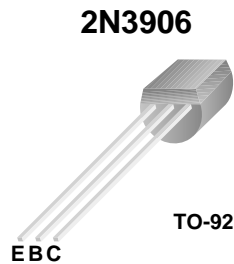

Ordering Information

Part Number	Marking	Package	Packing Method	Pack Quantity
2N3906BU	2N3906	TO-92 3L	Bulk	10000
2N3906TA	2N3906	TO-92 3L	Ammo	2000
2N3906TAR	2N3906	TO-92 3L	Ammo	2000
2N3906TF	2N3906	TO-92 3L	Tape and Reel	2000
2N3906TFR	2N3906	TO-92 3L	Tape and Reel	2000
MMBT3906	2A	SOT-23 3L	Tape and Reel	3000
PZT3906	3906	SOT-223 4L	Tape and Reel	2500

2N3906 / MMBT3906 / PZT3906 — PNP General-Purpose Amplifier

Absolute Maximum Ratings⁽¹⁾

Stresses exceeding the absolute maximum ratings may damage the device. The device may not function or be operable above the recommended operating conditions and stressing the parts to these levels is not recommended. In addition, extended exposure to stresses above the recommended operating conditions may affect device reliability. The absolute maximum ratings are stress ratings only. Values are at $T_A = 25^\circ\text{C}$ unless otherwise noted.

Symbol	Parameter	Value	Unit
V_{CEO}	Collector-Emitter Voltage	-40	V
V_{CBO}	Collector-Base Voltage	-40	V
V_{EBO}	Emitter-Base Voltage	-5.0	V
I_C	Collector Current - Continuous	-200	mA
T_J, T_{STG}	Operating and Storage Junction Temperature Range	-55 to +150	$^\circ\text{C}$

Note:

- These ratings are based on a maximum junction temperature of 150°C .
These are steady-state limits. ON Semiconductor should be consulted on applications involving pulsed or low-duty cycle operations.

Thermal Characteristics

Values are at $T_A = 25^\circ\text{C}$ unless otherwise noted.

Symbol	Parameter	Maximum			Unit
		2N3906 ⁽³⁾	MMBT3906 ⁽²⁾	PZT3906 ⁽³⁾	
P_D	Total Device Dissipation	625	350	1,000	mW
	Derate Above 25°C	5.0	2.8	8.0	$\text{mW}/^\circ\text{C}$
$R_{\theta JC}$	Thermal Resistance, Junction to Case	83.3			$^\circ\text{C}/\text{W}$
$R_{\theta JA}$	Thermal Resistance, Junction to Ambient	200	357	125	$^\circ\text{C}/\text{W}$

Notes:

- Device is mounted on FR-4 PCB 1.6 inch X 1.6 inch X 0.06 inch.
- PCB size: FR-4, 76 mm x 114 mm x 1.57 mm (3.0 inch x 4.5 inch x 0.062 inch) with minimum land pattern size.

Electrical Characteristics

Values are at $T_A = 25^\circ\text{C}$ unless otherwise noted.

Symbol	Parameter	Conditions	Min.	Max.	Unit
OFF CHARACTERISTICS					
$V_{(BR)CEO}$	Collector-Emitter Breakdown Voltage ⁽⁴⁾	$I_C = -1.0\text{ mA}, I_B = 0$	-40		V
$V_{(BR)CBO}$	Collector-Base Breakdown Voltage	$I_C = -10\ \mu\text{A}, I_E = 0$	-40		V
$V_{(BR)EBO}$	Emitter-Base Breakdown Voltage	$I_E = -10\ \mu\text{A}, I_C = 0$	-5.0		V
I_{BL}	Base Cut-Off Current	$V_{CE} = -30\text{ V}, V_{BE} = 3.0\text{ V}$		-50	nA
I_{CEX}	Collector Cut-Off Current	$V_{CE} = -30\text{ V}, V_{BE} = 3.0\text{ V}$		-50	nA
ON CHARACTERISTICS					
h_{FE}	DC Current Gain ⁽⁴⁾	$I_C = -0.1\text{ mA}, V_{CE} = -1.0\text{ V}$	60		
		$I_C = -1.0\text{ mA}, V_{CE} = -1.0\text{ V}$	80		
		$I_C = -10\text{ mA}, V_{CE} = -1.0\text{ V}$	100	300	
		$I_C = -50\text{ mA}, V_{CE} = -1.0\text{ V}$	60		
		$I_C = -100\text{ mA}, V_{CE} = -1.0\text{ V}$	30		
$V_{CE(sat)}$	Collector-Emitter Saturation Voltage	$I_C = -10\text{ mA}, I_B = -1.0\text{ mA}$		-0.25	V
		$I_C = -50\text{ mA}, I_B = -5.0\text{ mA}$		-0.40	
$V_{BE(sat)}$	Base-Emitter Saturation Voltage	$I_C = -10\text{ mA}, I_B = -1.0\text{ mA}$	-0.65	-0.85	V
		$I_C = -50\text{ mA}, I_B = -5.0\text{ mA}$		-0.95	
SMALL SIGNAL CHARACTERISTICS					
f_T	Current Gain - Bandwidth Product	$I_C = -10\text{ mA}, V_{CE} = -20\text{ V}, f = 100\text{ MHz}$	250		MHz
C_{obo}	Output Capacitance	$V_{CB} = -5.0\text{ V}, I_E = 0, f = 100\text{ kHz}$		4.5	pF
C_{ibo}	Input Capacitance	$V_{EB} = -0.5\text{ V}, I_C = 0, f = 100\text{ kHz}$		10.0	pF
NF	Noise Figure	$I_C = -100\ \mu\text{A}, V_{CE} = -5.0\text{ V}, R_S = 1.0\text{ k}\Omega, f = 10\text{ Hz to }15.7\text{ kHz}$		4.0	dB
SWITCHING CHARACTERISTICS					
t_d	Delay Time	$V_{CC} = -3.0\text{ V}, V_{BE} = -0.5\text{ V}$		35	ns
t_r	Rise Time	$I_C = -10\text{ mA}, I_{B1} = -1.0\text{ mA}$		35	ns
t_s	Storage Time	$V_{CC} = -3.0\text{ V}, I_C = -10\text{ mA}, I_{B1} = I_{B2} = -1.0\text{ mA}$		225	ns
t_f	Fall Time			75	ns

Note:

4. Pulse test: pulse width $\leq 300\ \mu\text{s}$, duty cycle $\leq 2.0\%$.

Typical Performance Characteristics

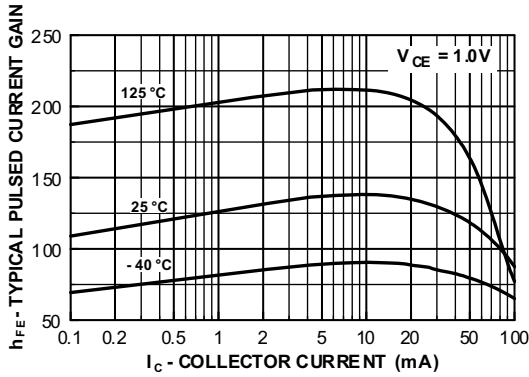

Figure 1. Typical Pulsed Current Gain vs. Collector Current

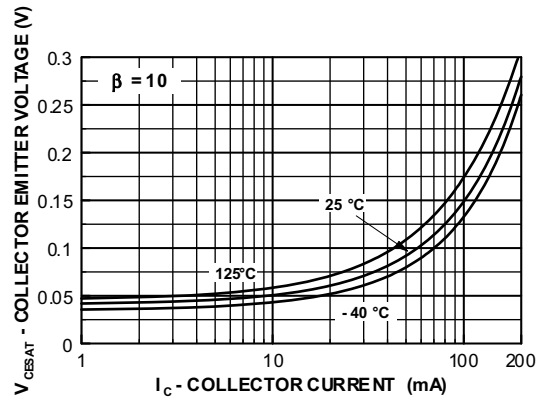

Figure 2. Collector-Emitter Saturation Voltage vs. Collector Current

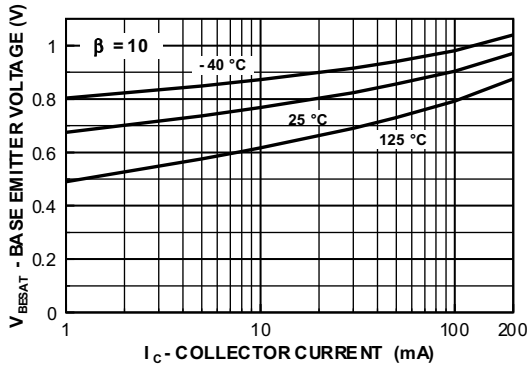

Figure 3. Base-Emitter Saturation Voltage vs. Collector Current

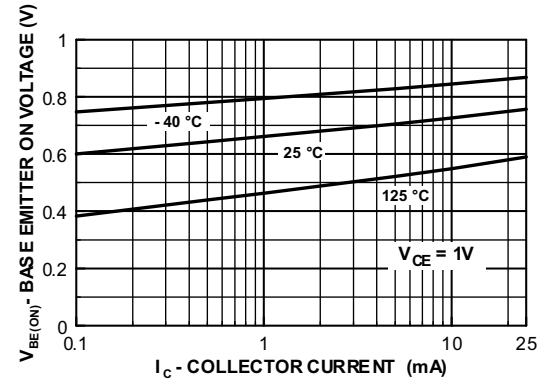

Figure 4. Base-Emitter On Voltage vs. Collector Current

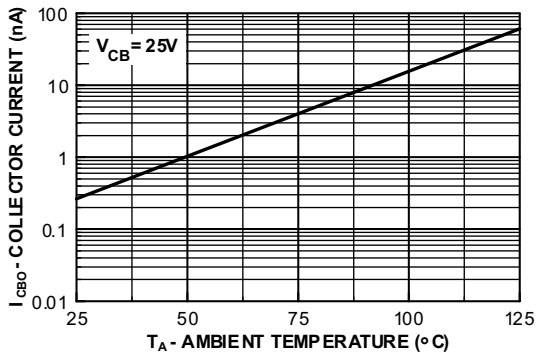

Figure 5. Collector Cut-Off Current vs. Ambient Temperature

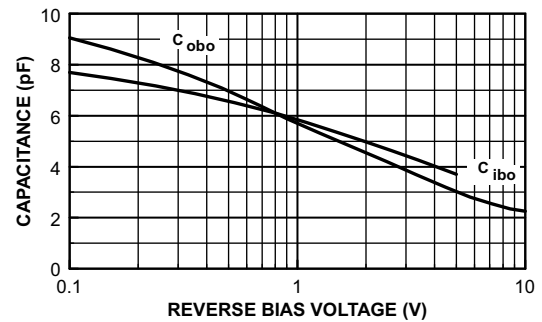

Figure 6. Common-Base Open Circuit Input and Output Capacitance vs. Reverse Bias Voltage

Typical Performance Characteristics (Continued)

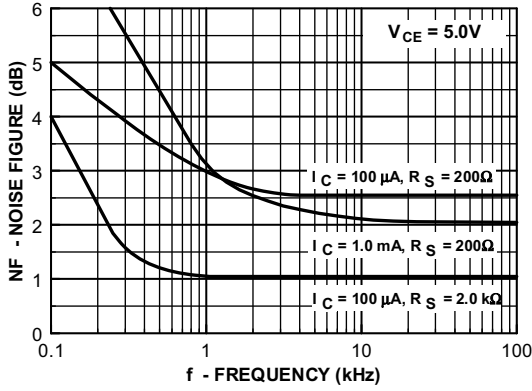

Figure 7. Noise Figure vs. Frequency

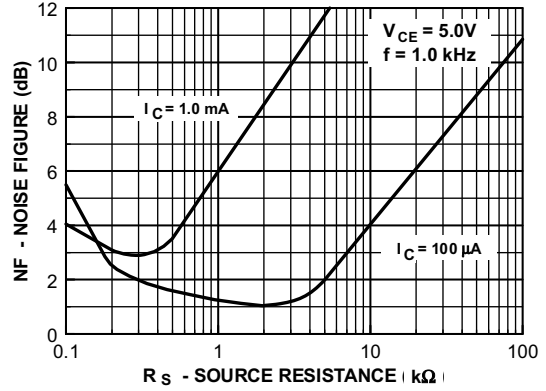

Figure 8. Noise Figure vs. Source Resistance

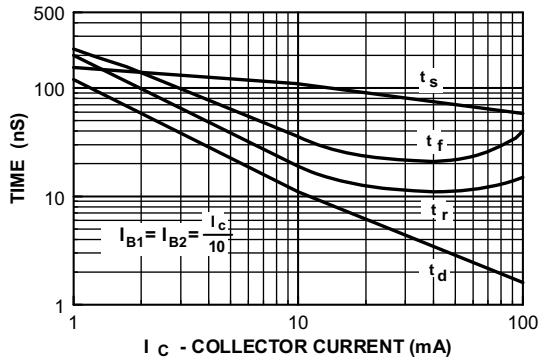

Figure 9. Switching Times vs. Collector Current

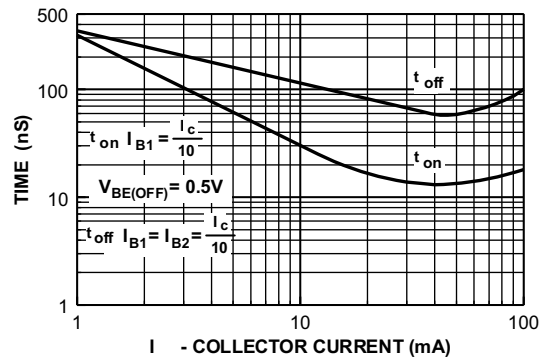

Figure 10. Turn-On and Turn-Off Times vs. Collector Current

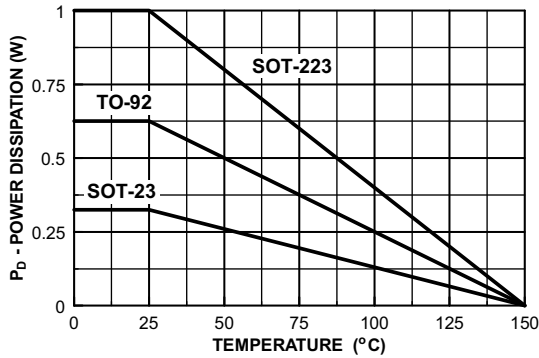

Figure 11. Power Dissipation vs. Ambient Temperature

Typical Performance Characteristics (Continued)

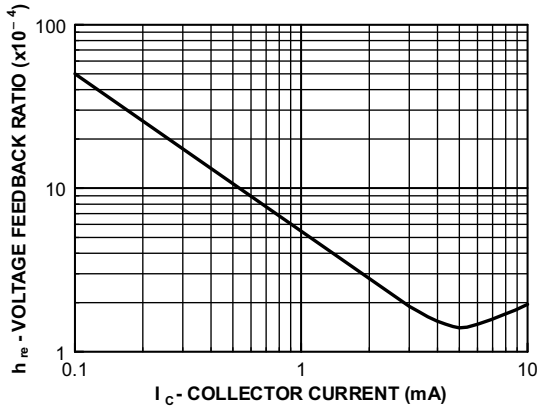

Figure 12. Voltage Feedback Ratio

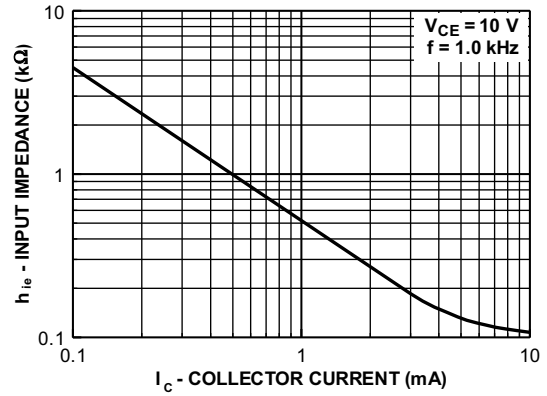

Figure 13. Input Impedance

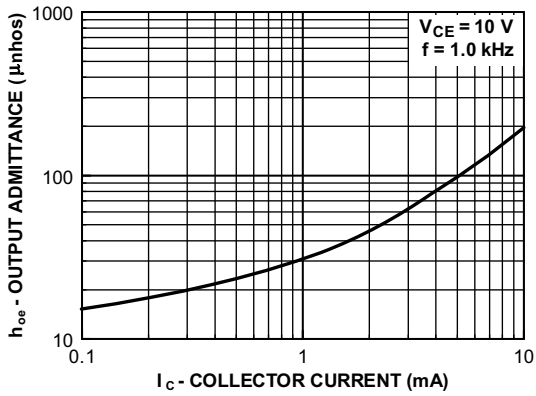

Figure 14. Output Admittance

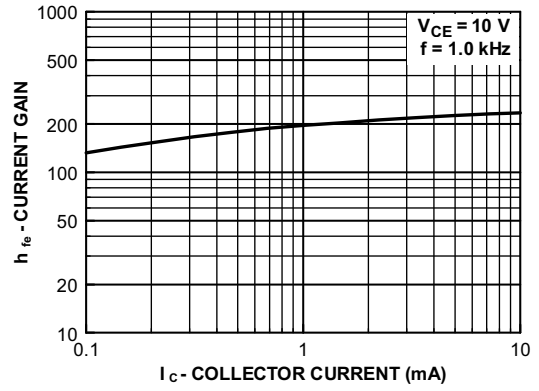
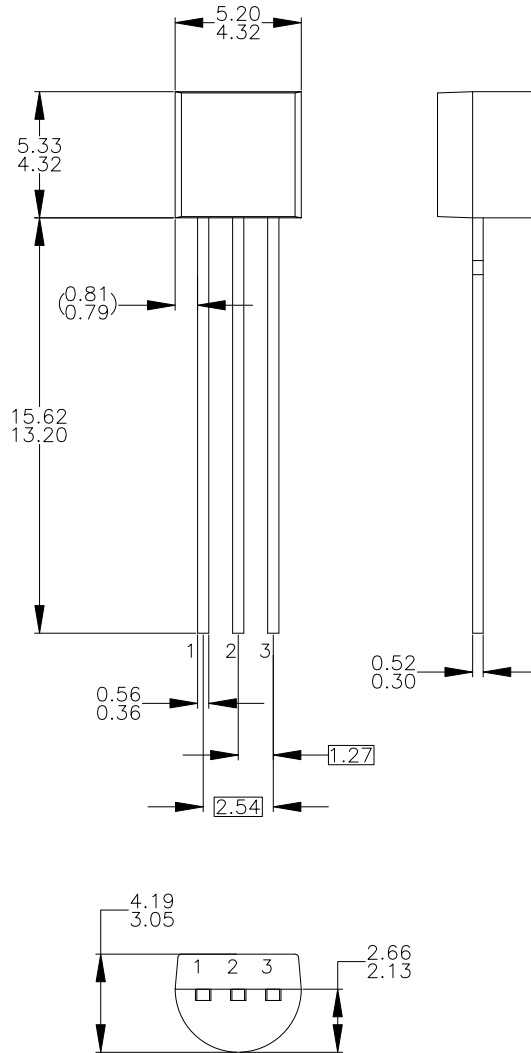

Figure 15. Current Gain

Physical Dimensions

TO-92 (Bulk)



NOTES: UNLESS OTHERWISE SPECIFIED

- A) DRAWING WITH REFERENCE TO JEDEC TO-92 RECOMMENDATIONS.
- B) ALL DIMENSIONS ARE IN MILLIMETERS.
- C) DRAWING CONFORMS TO ASME Y14.5M-1994.
- D) TO-92 (92,94,96,97,98) PIN CONFIGURATION:

Pin	92			94			96			97			98		
	P	F	M	P	F	M	B	F	M	P	F	M	P	F	M
1	E	S	S	E	S	S	B	D	G	C	G	D	C	G	D
2	B	D	G	C	G	D	E	S	S	B	D	G	E	S	S
3	C	G	D	B	D	G	C	G	D	E	S	S	B	D	G

LEGEND:

P - BIPOLAR E - EMITTER D - DRAIN
 F - JFET B - BASE S - SOURCE
 M - DMOS C - COLLECTOR G - GATE

- E) FOR PACKAGE 92, 94, 96, 97 AND 98:
PIN CONFIGURATION DRAIN "D" AND SOURCE "S"
ARE INTERCHANGEABLE AT JFET "F" OPTION.
- F) DRAWING FILENAME: MKT-ZA03DREV3.

Figure 16. 3-LEAD, TO92, JEDEC TO-92 COMPLIANT STRAIGHT LEAD CONFIGURATION (OLD TO92AM3)

Package drawings are provided as a service to customers considering ON Semiconductor components. Drawings may change in any manner without notice. Please note the revision and/or date on the drawing and contact a ON Semiconductor representative to verify or obtain the most recent revision. Package specifications do not expand the terms of ON Semiconductor's worldwide terms and conditions, specifically the warranty therein, which covers ON Semiconductor products.

Physical Dimensions (Continued)

TO-92 (Ammo, Tape and Reel)

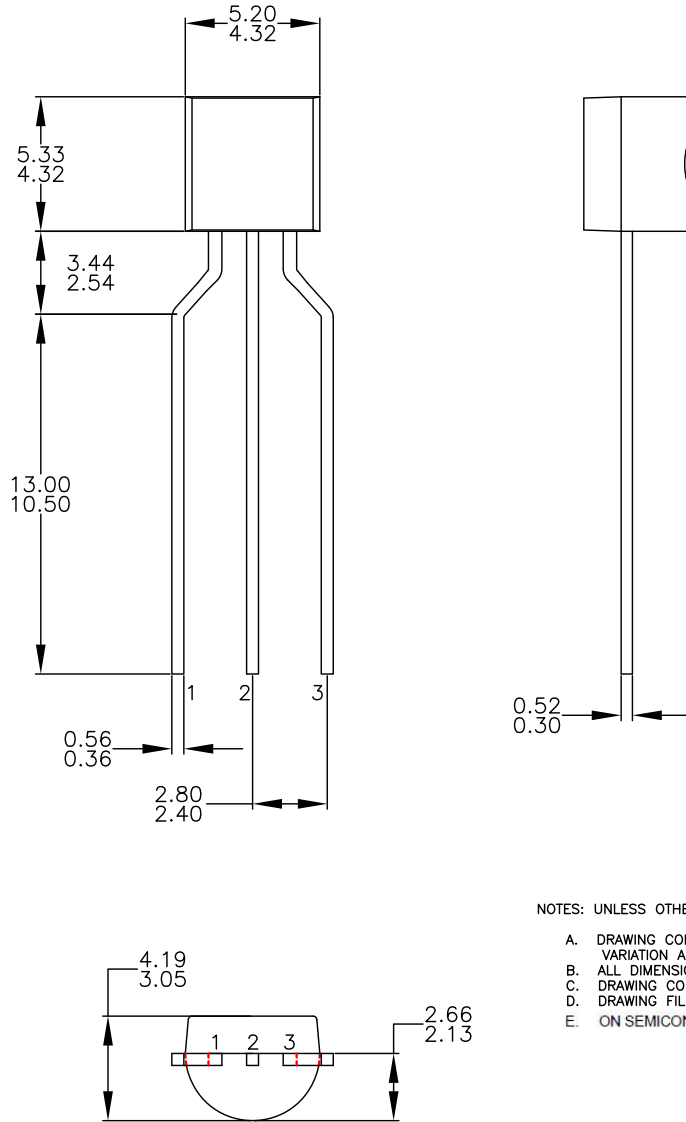

NOTES: UNLESS OTHERWISE SPECIFIED

- A. DRAWING CONFORMS TO JEDEC MS-013, VARIATION AC.
- B. ALL DIMENSIONS ARE IN MILLIMETERS.
- C. DRAWING CONFORMS TO ASME Y14.5M-2009.
- D. DRAWING FILENAME: MKT-ZA03FREV3.
- E. ON SEMICONDUCTOR

Figure 17. 3-LEAD, TO92, MOLDED 0.200 IN LINE SPACING LEAD FORM (J61Z OPTION)

Package drawings are provided as a service to customers considering ON Semiconductor components. Drawings may change in any manner without notice. Please note the revision and/or date on the drawing and contact a ON Semiconductor representative to verify or obtain the most recent revision. Package specifications do not expand the terms of ON Semiconductor's worldwide terms and conditions, specifically the warranty therein, which covers ON Semiconductor products.

Physical Dimensions (Continued)

SOT-23

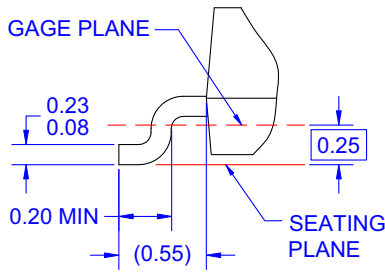
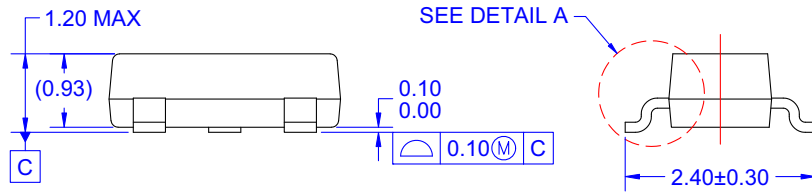
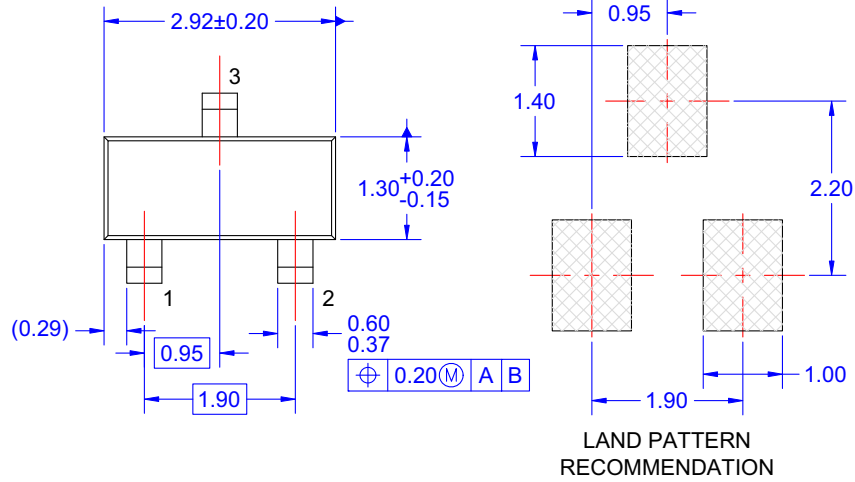

DETAIL A
SCALE: 2X

NOTES: UNLESS OTHERWISE SPECIFIED

- A) REFERENCE JEDEC REGISTRATION TO-236, VARIATION AB, ISSUE H.
- B) ALL DIMENSIONS ARE IN MILLIMETERS.
- C) DIMENSIONS ARE INCLUSIVE OF BURRS, MOLD FLASH AND TIE BAR EXTRUSIONS.
- D) DIMENSIONING AND TOLERANCING PER ASME Y14.5M - 1994.
- E) DRAWING FILE NAME: MA03DREV10

Figure 18. 3-LEAD, SOT23, JEDEC TO-236, LOW PROFILE

Package drawings are provided as a service to customers considering ON Semiconductor components. Drawings may change in any manner without notice. Please note the revision and/or date on the drawing and contact a ON Semiconductor representative to verify or obtain the most recent revision. Package specifications do not expand the terms of ON Semiconductor's worldwide terms and conditions, specifically the warranty therein, which covers ON Semiconductor products.

Physical Dimensions (Continued)

SOT-223 4L

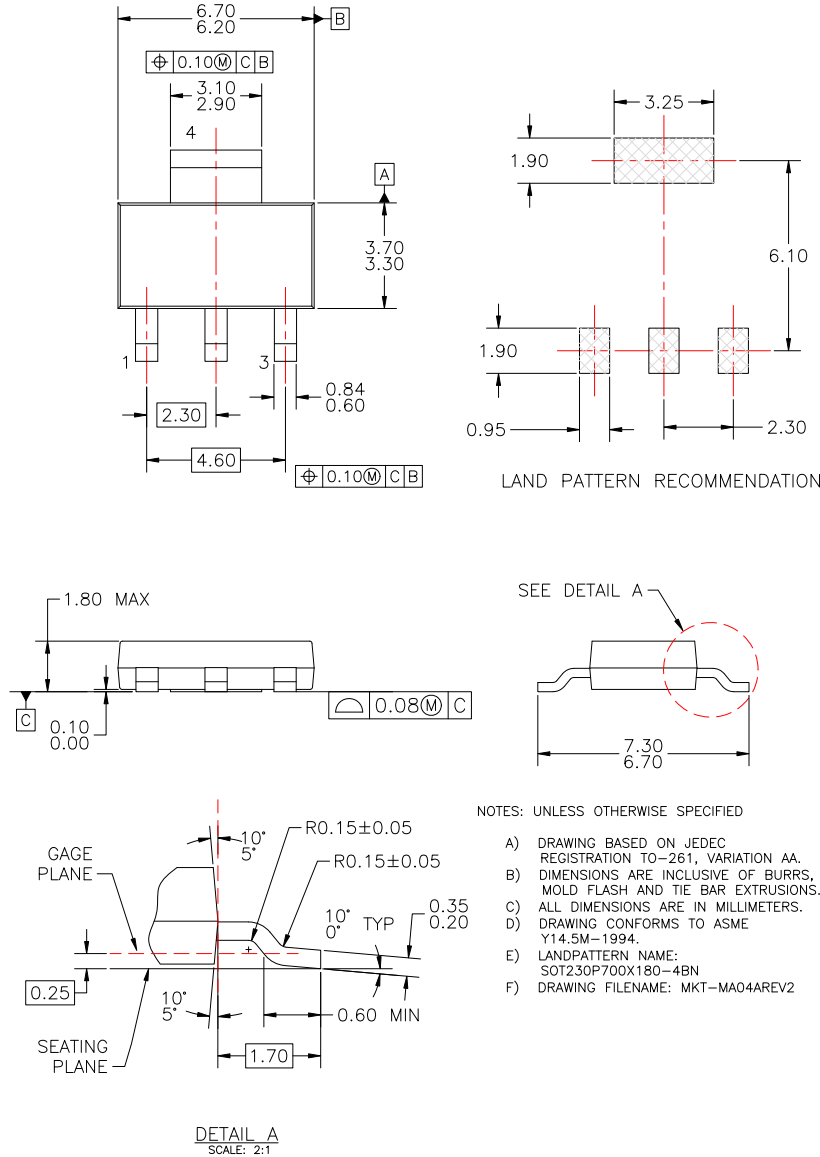

Figure 19. MOLDED PACKAGE, SOT-223, 4-LEAD

Package drawings are provided as a service to customers considering ON Semiconductor components. Drawings may change in any manner without notice. Please note the revision and/or date on the drawing and contact a ON Semiconductor representative to verify or obtain the most recent revision. Package specifications do not expand the terms of ON Semiconductor's worldwide terms and conditions, specifically the warranty therein, which covers ON Semiconductor products.

ON Semiconductor and  are trademarks of Semiconductor Components Industries, LLC dba ON Semiconductor or its subsidiaries in the United States and/or other countries. ON Semiconductor owns the rights to a number of patents, trademarks, copyrights, trade secrets, and other intellectual property. A listing of ON Semiconductor's product/patent coverage may be accessed at www.onsemi.com/site/pdf/Patent-Marking.pdf. ON Semiconductor reserves the right to make changes without further notice to any products herein. ON Semiconductor makes no warranty, representation or guarantee regarding the suitability of its products for any particular purpose, nor does ON Semiconductor assume any liability arising out of the application or use of any product or circuit, and specifically disclaims any and all liability, including without limitation special, consequential or incidental damages. Buyer is responsible for its products and applications using ON Semiconductor products, including compliance with all laws, regulations and safety requirements or standards, regardless of any support or applications information provided by ON Semiconductor. "Typical" parameters which may be provided in ON Semiconductor data sheets and/or specifications can and do vary in different applications and actual performance may vary over time. All operating parameters, including "Typicals" must be validated for each customer application by customer's technical experts. ON Semiconductor does not convey any license under its patent rights nor the rights of others. ON Semiconductor products are not designed, intended, or authorized for use as a critical component in life support systems or any FDA Class 3 medical devices or medical devices with a same or similar classification in a foreign jurisdiction or any devices intended for implantation in the human body. Should Buyer purchase or use ON Semiconductor products for any such unintended or unauthorized application, Buyer shall indemnify and hold ON Semiconductor and its officers, employees, subsidiaries, affiliates, and distributors harmless against all claims, costs, damages, and expenses, and reasonable attorney fees arising out of, directly or indirectly, any claim of personal injury or death associated with such unintended or unauthorized use, even if such claim alleges that ON Semiconductor was negligent regarding the design or manufacture of the part. ON Semiconductor is an Equal Opportunity/Affirmative Action Employer. This literature is subject to all applicable copyright laws and is not for resale in any manner.

PUBLICATION ORDERING INFORMATION

LITERATURE FULFILLMENT:

Literature Distribution Center for ON Semiconductor
19521 E. 32nd Pkwy, Aurora, Colorado 80011 USA
Phone: 303-675-2175 or 800-344-3860 Toll Free USA/Canada
Fax: 303-675-2176 or 800-344-3867 Toll Free USA/Canada
Email: orderlit@onsemi.com

N. American Technical Support: 800-282-9855 Toll Free
USA/Canada
Europe, Middle East and Africa Technical Support:
Phone: 421 33 790 2910
Japan Customer Focus Center
Phone: 81-3-5817-1050

ON Semiconductor Website: www.onsemi.com
Order Literature: <http://www.onsemi.com/orderlit>
For additional information, please contact your local
Sales Representative

X-ON Electronics

Largest Supplier of Electrical and Electronic Components

Click to view similar products for [Bipolar Transistors - BJT category](#):

Click to view products by [ON Semiconductor manufacturer](#):

Other Similar products are found below :

[619691C](#) [MCH4017-TL-H](#) [BC546/116](#) [BC557/116](#) [BSW67A](#) [NTE158](#) [NTE187A](#) [NTE195A](#) [NTE2302](#) [NTE2330](#) [NTE63](#) [C4460](#)
[2SA1419T-TD-H](#) [2SA1721-O\(TE85L,F\)](#) [2SA2126-E](#) [2SB1204S-TL-E](#) [2SC5488A-TL-H](#) [2SD2150T100R](#) [SP000011176](#) [FMMTA92QTA](#)
[2N2369ADCSM](#) [2SC2412KT146S](#) [2SC5490A-TL-H](#) [2SD1816S-TL-E](#) [2SD1816T-TL-E](#) [CMXT2207 TR](#) [CPH6501-TL-E](#) [MCH4021-TL-E](#)
[US6T6TR](#) [732314D](#) [CMXT3906 TR](#) [CPH3121-TL-E](#) [CPH6021-TL-H](#) [873787E](#) [UMX21NTR](#) [EMT2T2R](#) [MCH6102-TL-E](#) [FP204-TL-E](#)
[NJL0302DG](#) [2N3583](#) [2SA1434-TB-E](#) [2SC3143-4-TB-E](#) [2SD1621S-TD-E](#) [NTE103](#) [30A02MH-TL-E](#) [NSV40301MZ4T1G](#) [NTE101](#) [NTE13](#)
[NTE15](#) [NTE16001](#)