

# BC847CDXV6T1G, SBC847CDXV6T1G, BC847CDXV6T5G, BC848CDXV6T1G



ON Semiconductor®

<http://onsemi.com>

## Dual General Purpose Transistors

### NPN Duals

These transistors are designed for general purpose amplifier applications. They are housed in the SOT-563 which is designed for low power surface mount applications.

#### Features

- AEC-Q101 Qualified and PPAP Capable
- S Prefix for Automotive and Other Applications Requiring Unique Site and Control Change Requirements
- These are Pb-Free Devices

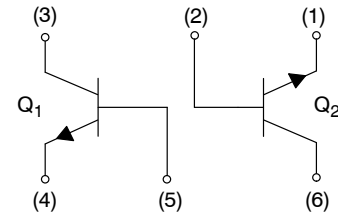

BC847CDXV6T1



SOT-563  
CASE 463A

#### MAXIMUM RATINGS

Rating	Symbol	BC847	BC848	Unit
Collector - Emitter Voltage	$V_{CEO}$	45	30	V
Collector - Base Voltage	$V_{CBO}$	50	30	V
Emitter - Base Voltage	$V_{EBO}$	6.0	5.0	V
Collector Current - Continuous	$I_C$	100	100	mAdc

Stresses exceeding Maximum Ratings may damage the device. Maximum Ratings are stress ratings only. Functional operation above the Recommended Operating Conditions is not implied. Extended exposure to stresses above the Recommended Operating Conditions may affect device reliability.

#### THERMAL CHARACTERISTICS

Characteristic (One Junction Heated)	Symbol	Max	Unit
Total Device Dissipation, (Note 1) $T_A = 25^\circ\text{C}$ Derate above $25^\circ\text{C}$	$P_D$	357 2.9	mW mW/ $^\circ\text{C}$
Thermal Resistance, Junction-to-Ambient (Note 1)	$R_{\theta JA}$	350	$^\circ\text{C}/\text{W}$
Characteristic (Both Junctions Heated)	Symbol	Max	Unit
Total Device Dissipation, (Note 1) $T_A = 25^\circ\text{C}$ Derate above $25^\circ\text{C}$	$P_D$	500 4.0	mW mW/ $^\circ\text{C}$
Thermal Resistance, Junction-to-Ambient (Note 1)	$R_{\theta JA}$	250	$^\circ\text{C}/\text{W}$
Junction and Storage Temperature Range	$T_J, T_{stg}$	-55 to +150	$^\circ\text{C}$

1. FR-4 @ Minimum Pad

#### MARKING DIAGRAMS

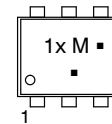

- 1x = Device Code  
x = G or M  
M = Date Code  
▪ = Pb-Free Package

(Note: Microdot may be in either location)

#### ORDERING INFORMATION

See detailed ordering and shipping information in the package dimensions section on page 2 of this data sheet.

# BC847CDXV6T1G, SBC847CDXV6T1G, BC847CDXV6T5G, BC848CDXV6T1G

## ELECTRICAL CHARACTERISTICS (T<sub>A</sub> = 25°C unless otherwise noted)

Characteristic	Symbol	Min	Typ	Max	Unit
<b>OFF CHARACTERISTICS</b>					
Collector – Emitter Breakdown Voltage (I <sub>C</sub> = 10 mA)	V <sub>(BR)CEO</sub> BC847CDXV6T1, SBC847CDXV6 BC848CDXV6T1	45 30	– –	– –	V
Collector – Emitter Breakdown Voltage (I <sub>C</sub> = 10 μA, V <sub>EB</sub> = 0)	V <sub>(BR)CES</sub> BC847CDXV6T1, SBC847CDXV6 BC848CDXV6T1	50 30	– –	– –	V
Collector – Base Breakdown Voltage (I <sub>C</sub> = 10 μA)	V <sub>(BR)CBO</sub> BC847CDXV6T1, SBC847CDXV6 BC848CDXV6T1	50 30	– –	– –	V
Emitter – Base Breakdown Voltage (I <sub>E</sub> = 1.0 μA)	V <sub>(BR)EBO</sub> BC847CDXV6T1, SBC847CDXV6 BC848CDXV6T1	6.0 5.0	– –	– –	V
Collector Cutoff Current (V <sub>CB</sub> = 30 V)	I <sub>CBO</sub> (V <sub>CB</sub> = 30 V, T <sub>A</sub> = 150°C)	– –	– –	15 5.0	nA μA

## ON CHARACTERISTICS

DC Current Gain (I <sub>C</sub> = 10 μA, V <sub>CE</sub> = 5.0 V) (I <sub>C</sub> = 2.0 mA, V <sub>CE</sub> = 5.0 V)	h <sub>FE</sub>	– 420	270 520	– 800	–
Collector – Emitter Saturation Voltage (I <sub>C</sub> = 10 mA, I <sub>B</sub> = 0.5 mA) (I <sub>C</sub> = 100 mA, I <sub>B</sub> = 5.0 mA)	V <sub>CE(sat)</sub>	– –	– –	0.25 0.6	V
Base – Emitter Saturation Voltage (I <sub>C</sub> = 10 mA, I <sub>B</sub> = 0.5 mA) (I <sub>C</sub> = 100 mA, I <sub>B</sub> = 5.0 mA)	V <sub>BE(sat)</sub>	– –	0.7 0.9	– –	V
Base – Emitter Voltage (I <sub>C</sub> = 2.0 mA, V <sub>CE</sub> = 5.0 V) (I <sub>C</sub> = 10 mA, V <sub>CE</sub> = 5.0 V)	V <sub>BE(on)</sub>	580 –	660 –	700 770	mV

## SMALL-SIGNAL CHARACTERISTICS

Current – Gain – Bandwidth Product (I <sub>C</sub> = 10 mA, V <sub>CE</sub> = 5.0 Vdc, f = 100 MHz)	f <sub>T</sub>	100	–	–	MHz
Output Capacitance (V <sub>CB</sub> = 10 V, f = 1.0 MHz)	C <sub>obo</sub>	–	–	1.5	pF
Noise Figure (I <sub>C</sub> = 0.2 mA, V <sub>CE</sub> = 5.0 Vdc, R <sub>S</sub> = 2.0 kΩ, f = 1.0 kHz, BW = 200 Hz)	NF	–	–	10	dB

## ORDERING INFORMATION

Device	Specific Marking	Package	Shipping <sup>†</sup>
BC847CDXV6T1G	1G	SOT-563 (Pb-Free)	4000 Units / Tape & Reel
SBC847CDXV6T1G			8000 Units / Tape & Reel
BC847CDXV6T5G			4000 Units / Tape & Reel
BC848CDXV6T1G	1L	SOT-563 (Pb-Free)	4000 Units / Tape & Reel

<sup>†</sup>For information on tape and reel specifications, including part orientation and tape sizes, please refer to our Tape and Reel Packaging Specifications Brochure, BRD8011/D.

TYPICAL CHARACTERISTICS

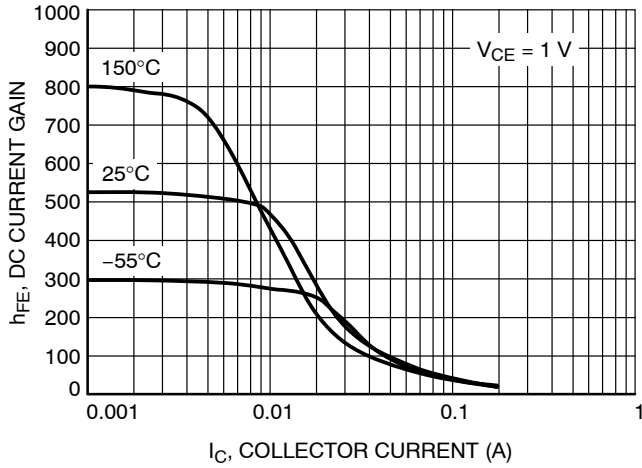

Figure 1. DC Current Gain vs. Collector Current

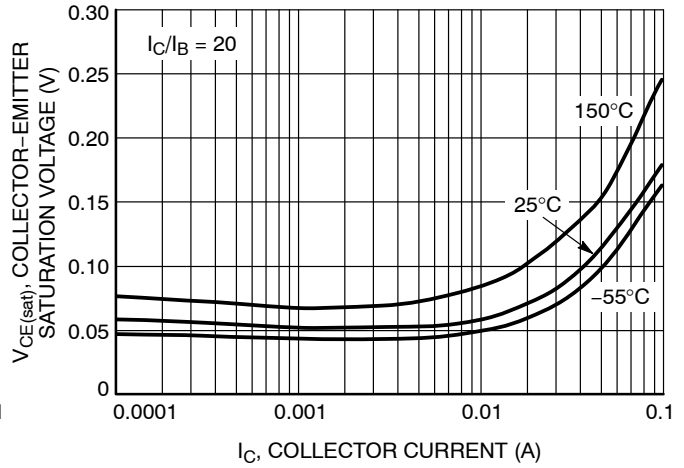

Figure 2. Collector Emitter Saturation Voltage vs. Collector Current

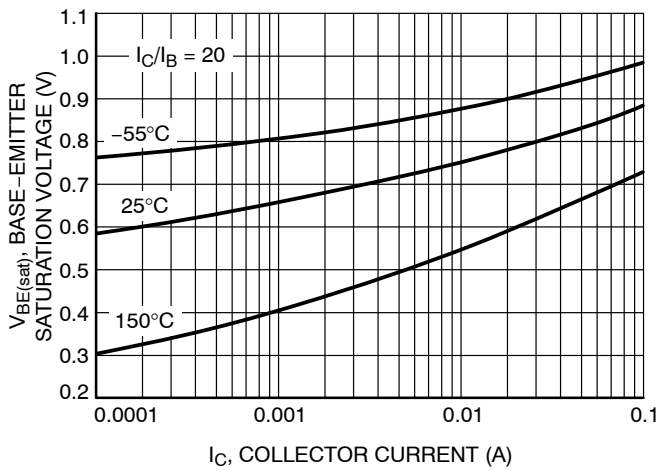

Figure 3. Base Emitter Saturation Voltage vs. Collector Current

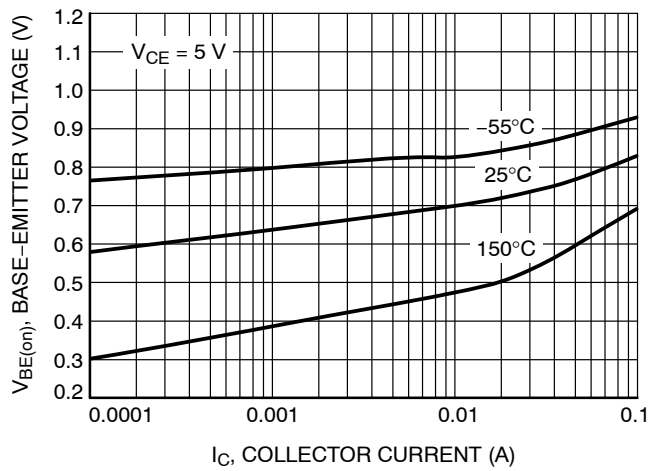

Figure 4. Base Emitter Voltage vs. Collector Current

TYPICAL CHARACTERISTICS

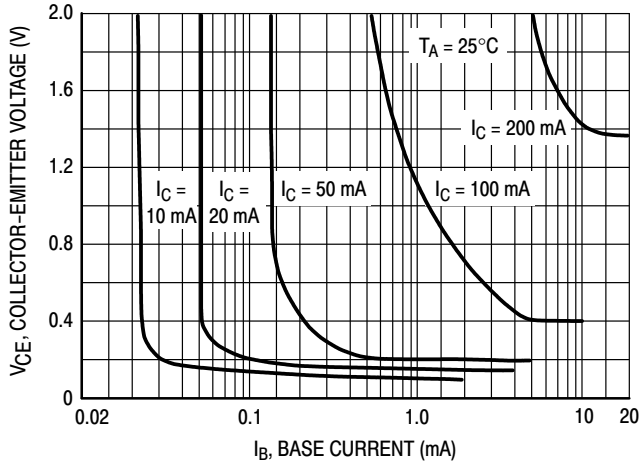

Figure 5. Collector Saturation Region

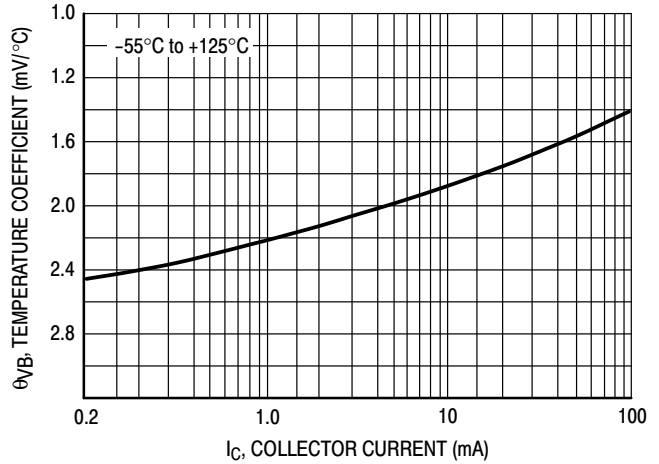

Figure 6. Base-Emitter Temperature Coefficient

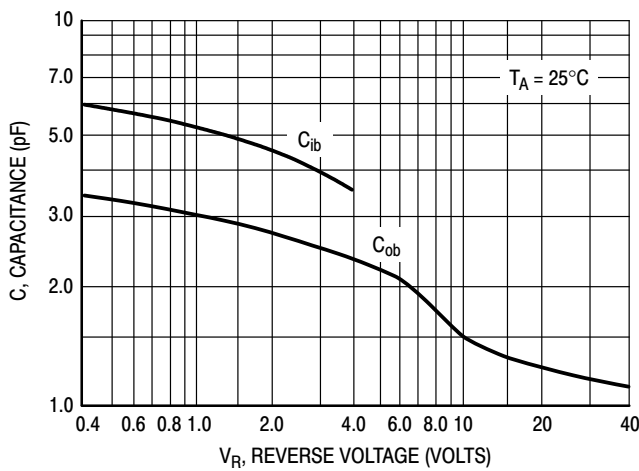

Figure 7. Capacitances

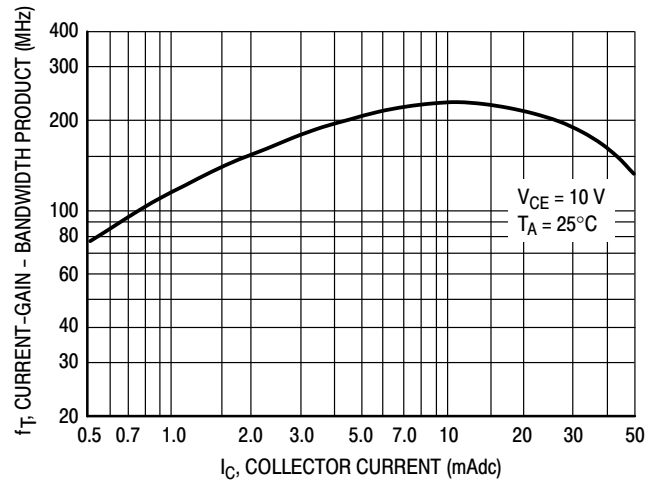

Figure 8. Current-Gain - Bandwidth Product

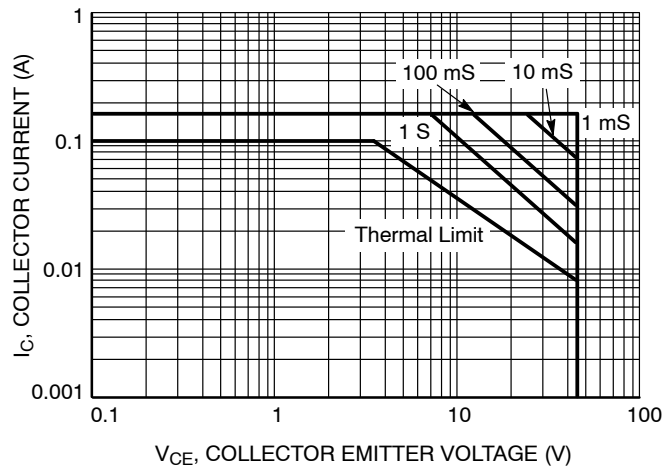
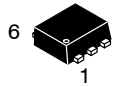

Figure 9. Safe Operating Area

# MECHANICAL CASE OUTLINE

## PACKAGE DIMENSIONS

ON Semiconductor®



SCALE 4:1

**SOT-563, 6 LEAD**  
CASE 463A  
ISSUE H

DATE 26 JAN 2021

**NOTES:**

1. DIMENSIONING AND TOLERANCING PER ASME Y14.5M, 2009.
2. CONTROLLING DIMENSION: MILLIMETERS
3. MAXIMUM LEAD THICKNESS INCLUDES LEAD FINISH THICKNESS. MINIMUM LEAD THICKNESS IS THE MINIMUM THICKNESS OF BASE MATERIAL.

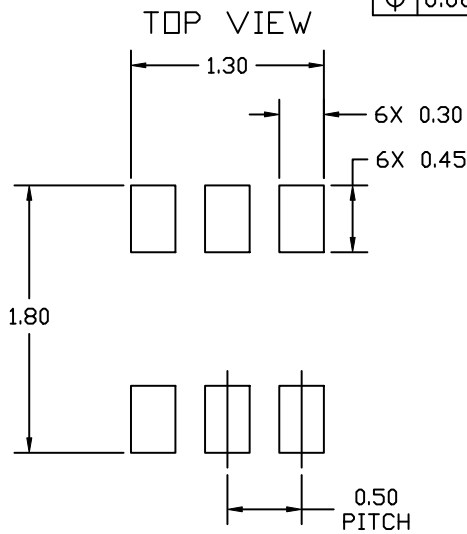
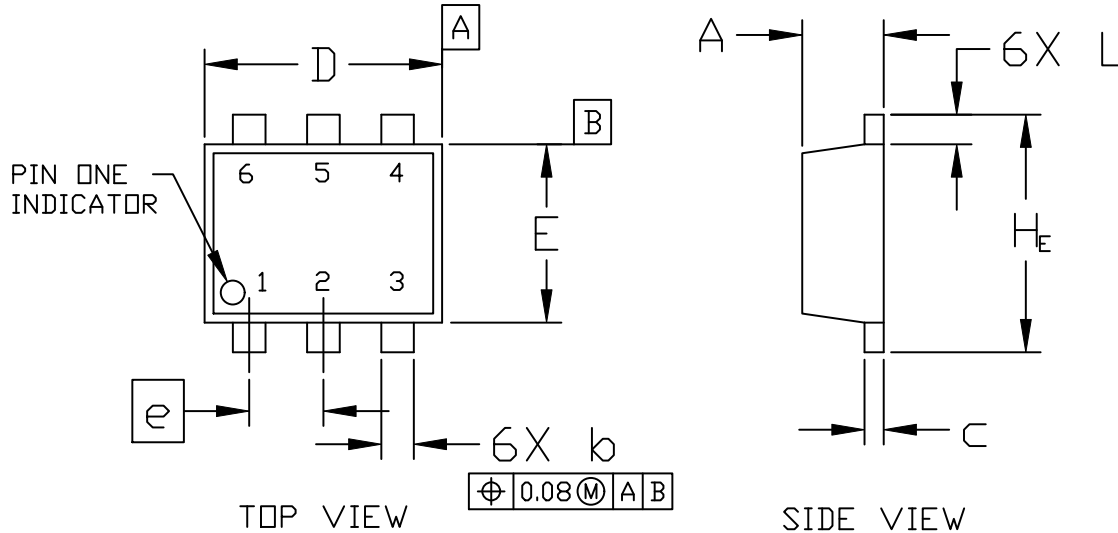

DIM	MILLIMETERS		
	MIN.	NOM.	MAX.
A	0.50	0.55	0.60
b	0.17	0.22	0.27
c	0.08	0.13	0.18
D	1.50	1.60	1.70
E	1.10	1.20	1.30
e	0.50 BSC		
L	0.10	0.20	0.30
H <sub>E</sub>	1.50	1.60	1.70

**RECOMMENDED MOUNTING FOOTPRINT\***

\* For additional information on our Pb-Free strategy and soldering details, please download the ON Semiconductor Soldering and Mounting Techniques Reference Manual, SOLDERRM/D.

<b>DOCUMENT NUMBER:</b>	<b>98AON11126D</b>	Electronic versions are uncontrolled except when accessed directly from the Document Repository. Printed versions are uncontrolled except when stamped "CONTROLLED COPY" in red.
<b>DESCRIPTION:</b>	<b>SOT-563, 6 LEAD</b>	<b>PAGE 1 OF 2</b>

ON Semiconductor and are trademarks of Semiconductor Components Industries, LLC dba ON Semiconductor or its subsidiaries in the United States and/or other countries. ON Semiconductor reserves the right to make changes without further notice to any products herein. ON Semiconductor makes no warranty, representation or guarantee regarding the suitability of its products for any particular purpose, nor does ON Semiconductor assume any liability arising out of the application or use of any product or circuit, and specifically disclaims any and all liability, including without limitation special, consequential or incidental damages. ON Semiconductor does not convey any license under its patent rights nor the rights of others.

**SOT-563, 6 LEAD**  
CASE 463A  
ISSUE H

DATE 26 JAN 2021

STYLE 1: PIN 1. EMITTER 1 2. BASE 1 3. COLLECTOR 2 4. EMITTER 2 5. BASE 2 6. COLLECTOR 1	STYLE 2: PIN 1. EMITTER 1 2. EMITTER 2 3. BASE 2 4. COLLECTOR 2 5. BASE 1 6. COLLECTOR 1	STYLE 3: PIN 1. CATHODE 1 2. CATHODE 1 3. ANODE/ANODE 2 4. CATHODE 2 5. CATHODE 2 6. ANODE/ANODE 1
--	--	--

STYLE 4: PIN 1. COLLECTOR 2. COLLECTOR 3. BASE 4. EMITTER 5. COLLECTOR 6. COLLECTOR	STYLE 5: PIN 1. CATHODE 2. CATHODE 3. ANODE 4. ANODE 5. CATHODE 6. CATHODE	STYLE 6: PIN 1. CATHODE 2. ANODE 3. CATHODE 4. CATHODE 5. CATHODE 6. CATHODE
---	--	--

STYLE 7: PIN 1. CATHODE 2. ANODE 3. CATHODE 4. CATHODE 5. ANODE 6. CATHODE	STYLE 8: PIN 1. DRAIN 2. DRAIN 3. GATE 4. SOURCE 5. DRAIN 6. DRAIN	STYLE 9: PIN 1. SOURCE 1 2. GATE 1 3. DRAIN 2 4. SOURCE 2 5. GATE 2 6. DRAIN 1
--	--	--

STYLE 10: PIN 1. CATHODE 1 2. N/C 3. CATHODE 2 4. ANODE 2 5. N/C 6. ANODE 1	STYLE 11: PIN 1. EMITTER 2 2. BASE 2 3. COLLECTOR 1 4. EMITTER 1 5. BASE 1 6. COLLECTOR 2
---	---

**GENERIC  
MARKING DIAGRAM\***

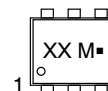

XX = Specific Device Code  
M = Month Code  
■ = Pb-Free Package

\*This information is generic. Please refer to device data sheet for actual part marking. Pb-Free indicator, "G" or microdot "■", may or may not be present. Some products may not follow the Generic Marking.

<b>DOCUMENT NUMBER:</b>	<b>98AON11126D</b>	Electronic versions are uncontrolled except when accessed directly from the Document Repository. Printed versions are uncontrolled except when stamped "CONTROLLED COPY" in red.
<b>DESCRIPTION:</b>	<b>SOT-563, 6 LEAD</b>	<b>PAGE 2 OF 2</b>

ON Semiconductor and are trademarks of Semiconductor Components Industries, LLC dba ON Semiconductor or its subsidiaries in the United States and/or other countries. ON Semiconductor reserves the right to make changes without further notice to any products herein. ON Semiconductor makes no warranty, representation or guarantee regarding the suitability of its products for any particular purpose, nor does ON Semiconductor assume any liability arising out of the application or use of any product or circuit, and specifically disclaims any and all liability, including without limitation special, consequential or incidental damages. ON Semiconductor does not convey any license under its patent rights nor the rights of others.

**onsemi**, **Onsemi**, and other names, marks, and brands are registered and/or common law trademarks of Semiconductor Components Industries, LLC dba "**onsemi**" or its affiliates and/or subsidiaries in the United States and/or other countries. **onsemi** owns the rights to a number of patents, trademarks, copyrights, trade secrets, and other intellectual property. A listing of **onsemi**'s product/patent coverage may be accessed at [www.onsemi.com/site/pdf/Patent-Marking.pdf](http://www.onsemi.com/site/pdf/Patent-Marking.pdf). **onsemi** reserves the right to make changes at any time to any products or information herein, without notice. The information herein is provided "as-is" and **onsemi** makes no warranty, representation or guarantee regarding the accuracy of the information, product features, availability, functionality, or suitability of its products for any particular purpose, nor does **onsemi** assume any liability arising out of the application or use of any product or circuit, and specifically disclaims any and all liability, including without limitation special, consequential or incidental damages. Buyer is responsible for its products and applications using **onsemi** products, including compliance with all laws, regulations and safety requirements or standards, regardless of any support or applications information provided by **onsemi**. "Typical" parameters which may be provided in **onsemi** data sheets and/or specifications can and do vary in different applications and actual performance may vary over time. All operating parameters, including "Typicals" must be validated for each customer application by customer's technical experts. **onsemi** does not convey any license under any of its intellectual property rights nor the rights of others. **onsemi** products are not designed, intended, or authorized for use as a critical component in life support systems or any FDA Class 3 medical devices or medical devices with a same or similar classification in a foreign jurisdiction or any devices intended for implantation in the human body. Should Buyer purchase or use **onsemi** products for any such unintended or unauthorized application, Buyer shall indemnify and hold **onsemi** and its officers, employees, subsidiaries, affiliates, and distributors harmless against all claims, costs, damages, and expenses, and reasonable attorney fees arising out of, directly or indirectly, any claim of personal injury or death associated with such unintended or unauthorized use, even if such claim alleges that **onsemi** was negligent regarding the design or manufacture of the part. **onsemi** is an Equal Opportunity/Affirmative Action Employer. This literature is subject to all applicable copyright laws and is not for resale in any manner.

## PUBLICATION ORDERING INFORMATION

### LITERATURE FULFILLMENT:

Email Requests to: [orderlit@onsemi.com](mailto:orderlit@onsemi.com)

**onsemi Website:** [www.onsemi.com](http://www.onsemi.com)

### TECHNICAL SUPPORT

**North American Technical Support:**

Voice Mail: 1 800-282-9855 Toll Free USA/Canada

Phone: 011 421 33 790 2910

**Europe, Middle East and Africa Technical Support:**

Phone: 00421 33 790 2910

For additional information, please contact your local Sales Representative

## X-ON Electronics

Largest Supplier of Electrical and Electronic Components

*Click to view similar products for [Bipolar Transistors - BJT category](#):*

*Click to view products by [ON Semiconductor manufacturer](#):*

Other Similar products are found below :

[619691C](#) [MCH4017-TL-H](#) [BC546/116](#) [BC557/116](#) [BSW67A](#) [NTE158](#) [NTE187A](#) [NTE195A](#) [NTE2302](#) [NTE2330](#) [NTE63](#) [C4460](#)  
[2SA1419T-TD-H](#) [2SA1721-O\(TE85L,F\)](#) [2SA2126-E](#) [2SB1204S-TL-E](#) [2SC5488A-TL-H](#) [2SD2150T100R](#) [SP000011176](#) [FMMTA92QTA](#)  
[2N2369ADCSM](#) [2N5769](#) [2SC2412KT146S](#) [2SC5490A-TL-H](#) [2SD1816S-TL-E](#) [2SD1816T-TL-E](#) [CMXT2207 TR](#) [CPH6501-TL-E](#)  
[MCH4021-TL-E](#) [US6T6TR](#) [NJL0281DG](#) [732314D](#) [CMXT3906 TR](#) [CPH3121-TL-E](#) [CPH6021-TL-H](#) [873787E](#) [IMZ2AT108](#) [UMX21NTR](#)  
[EMT2T2R](#) [MCH6102-TL-E](#) [FP204-TL-E](#) [NJL0302DG](#) [2N3583](#) [2SA1434-TB-E](#) [2SC3143-4-TB-E](#) [2SD1621S-TD-E](#) [NTE103](#) [30A02MH-TL-E](#) [NSV40301MZ4T1G](#) [NTE101](#)