



Is Now Part of



ON Semiconductor®

To learn more about ON Semiconductor, please visit our website at
www.onsemi.com

Please note: As part of the Fairchild Semiconductor integration, some of the Fairchild orderable part numbers will need to change in order to meet ON Semiconductor's system requirements. Since the ON Semiconductor product management systems do not have the ability to manage part nomenclature that utilizes an underscore (_), the underscore (_) in the Fairchild part numbers will be changed to a dash (-). This document may contain device numbers with an underscore (_). Please check the ON Semiconductor website to verify the updated device numbers. The most current and up-to-date ordering information can be found at www.onsemi.com. Please email any questions regarding the system integration to Fairchild_questions@onsemi.com.

ON Semiconductor and the ON Semiconductor logo are trademarks of Semiconductor Components Industries, LLC dba ON Semiconductor or its subsidiaries in the United States and/or other countries. ON Semiconductor owns the rights to a number of patents, trademarks, copyrights, trade secrets, and other intellectual property. A listing of ON Semiconductor's product/patent coverage may be accessed at www.onsemi.com/site/pdf/Patent-Marking.pdf. ON Semiconductor reserves the right to make changes without further notice to any products herein. ON Semiconductor makes no warranty, representation or guarantee regarding the suitability of its products for any particular purpose, nor does ON Semiconductor assume any liability arising out of the application or use of any product or circuit, and specifically disclaims any and all liability, including without limitation special, consequential or incidental damages. Buyer is responsible for its products and applications using ON Semiconductor products, including compliance with all laws, regulations and safety requirements or standards, regardless of any support or applications information provided by ON Semiconductor. "Typical" parameters which may be provided in ON Semiconductor data sheets and/or specifications can and do vary in different applications and actual performance may vary over time. All operating parameters, including "Typicals" must be validated for each customer application by customer's technical experts. ON Semiconductor does not convey any license under its patent rights nor the rights of others. ON Semiconductor products are not designed, intended, or authorized for use as a critical component in life support systems or any FDA Class 3 medical devices or medical devices with a same or similar classification in a foreign jurisdiction or any devices intended for implantation in the human body. Should Buyer purchase or use ON Semiconductor products for any such unintended or unauthorized application, Buyer shall indemnify and hold ON Semiconductor and its officers, employees, subsidiaries, affiliates, and distributors harmless against all claims, costs, damages, and expenses, and reasonable attorney fees arising out of, directly or indirectly, any claim of personal injury or death associated with such unintended or unauthorized use, even if such claim alleges that ON Semiconductor was negligent regarding the design or manufacture of the part. ON Semiconductor is an Equal Opportunity/Affirmative Action Employer. This literature is subject to all applicable copyright laws and is not for resale in any manner.



November 2014

SMBJ5V0(C)A - SMBJ170(C)A 600 Watt Transient Voltage Suppressors

Features

- Glass-Passivated Junction
- 600 W Peak Pulse Power Capability on 10/1000 μ s Waveform.
- Excellent Clamping Capability
- Low-Incremental Surge Resistance
- Fast Response Time: Typically Less than 1.0 ps from 0 V to BV minimum for Unidirectional and 5.0 ns for Bidirectional
- Typical I_R Less than 1.0 μ A Above 10 V
- UL Certificate #E258596

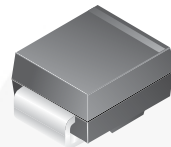

SMB/DO-214AA

Band denotes cathode on unidirectional devices only. No band on bi-directional devices. Bi-directional types have CA suffix where electrical characteristics apply in both directions suitable for bi-directional applications.

Absolute Maximum Ratings

Stresses exceeding the absolute maximum ratings may damage the device. The device may not function or be operable above the recommended operating conditions and stressing the parts to these levels is not recommended. In addition, extended exposure to stresses above the recommended operating conditions may affect device reliability. The absolute maximum ratings are stress ratings only. Values are at $T_A = 25^\circ\text{C}$ unless otherwise noted.

Symbol	Parameter	Value	Unit
P_{PPM}	Peak Pulse Power Dissipation on 10/1000 μ s Waveform	600	W
I_{PPM}	Peak Pulse Current on 10/1000 μ s Waveform	See Table	A
I_{FSM}	Non-Repetitive Peak Forward Surge Current Superimposed on Rated Load (JEDEC Method) ⁽¹⁾	100	A
T_{STG}	Storage Temperature Range	-55 to 150	$^\circ\text{C}$
T_J	Operating Junction Temperature Range	-55 to 150	$^\circ\text{C}$

Note:

1. Measured on 8.3 ms single half-sine wave or equivalent square wave: duty cycle = 4 pulses per minute maximum.

SMBJ5V0(C)A - SMBJ170(C)A — 600 Watt Transient Voltage Suppressors

Electrical Characteristics

Values are at $T_A = 25^\circ\text{C}$ unless otherwise noted.

Uni-Directional Bi-Directional (C) Device	Part Marking ⁽²⁾	Reverse Stand-Off Voltage V_{RWM} (V)	Breakdown Voltage V_{BR} (V)		Test Current I_T (mA)	Clamping Voltage at I_{PPM} V_C (V)	Peak Pulse Current I_{PPM} (A)	Reverse Leakage at V_{RWM} I_R (μA) ⁽³⁾
			Min.	Max.				
SMBJ5V0(C)A	KE	5.0	6.40	7.00	10	9.2	65.2	800
SMBJ6V0(C)A	KG	6.0	6.67	7.37	10	10.3	58.3	800
SMBJ6V5(C)A	KK	6.5	7.22	7.98	10	11.2	53.6	500
SMBJ7V0(C)A	KM	7.0	7.78	8.60	10	12.0	50.0	200
SMBJ7V5(C)A	KP	7.5	8.33	9.21	1	12.9	46.5	100
SMBJ8V0(C)A	KR	8.0	8.89	9.83	1	13.6	44.1	50
SMBJ8V5(C)A	KT	8.5	9.44	10.4	1	14.4	41.7	20
SMBJ9V0(C)A	KV	9.0	10.0	11.1	1	15.4	39.0	10
SMBJ10(C)A	KX	10	11.1	12.8	1	17.0	35.3	5
SMBJ11(C)A	KZ	11	12.2	13.5	1	18.2	33.0	5
SMBJ12(C)A	LE	12	13.3	14.7	1	19.9	30.2	5
SMBJ13(C)A	LG	13	14.4	15.9	1	21.5	27.9	5
SMBJ14(C)A	LK	14	15.6	17.2	1	23.2	25.9	5
SMBJ15(C)A	LM	15	16.7	18.5	1	24.4	24.6	5
SMBJ16(C)A	LP	16	17.8	19.7	1	26.0	23.1	5
SMBJ17(C)A	LR	17	18.9	20.9	1	27.6	21.7	5
SMBJ18(C)A	LT	18	20.0	22.1	1	29.2	20.5	5
SMBJ20(C)A	LV	20	22.2	24.5	1	32.4	18.5	5
SMBJ22(C)A	LX	22	24.4	26.9	1	35.5	16.9	5
SMBJ24(C)A	LZ	24	26.7	29.5	1	38.9	15.4	5
SMBJ26(C)A	ME	26	28.9	31.9	1	42.1	14.3	5
SMBJ28(C)A	MG	28	31.1	34.4	1	45.4	13.2	5
SMBJ30(C)A	MK	30	33.3	36.8	1	48.4	12.4	5
SMBJ33(C)A	MM	33	36.7	40.6	1	53.3	11.3	5
SMBJ36(C)A	MP	36	40.0	44.2	1	58.1	10.3	5
SMBJ40(C)A	MR	40	44.4	49.1	1	64.5	9.3	5
SMBJ43(C)A	MT	43	47.8	52.8	1	69.4	8.6	5
SMBJ45(C)A	MV	45	50.0	55.3	1	72.7	8.3	5
SMBJ48(C)A	MX	48	53.3	58.9	1	77.4	7.8	5
SMBJ51(C)A	MZ	51	56.7	62.7	1	82.4	7.3	5
SMBJ54(C)A	NE	54	60.0	66.3	1	87.1	6.9	5
SMBJ58(C)A	NG	58	64.4	71.2	1	93.6	6.4	5
SMBJ60(C)A	NK	60	66.7	73.7	1	96.8	6.2	5
SMBJ64(C)A	NM	64	71.1	78.6	1	103.0	5.8	5
SMBJ70(C)A	NP	70	77.8	86.0	1	113.0	5.3	5
SMBJ75(C)A	NR	75	83.3	92.1	1	121.0	5.0	5
SMBJ78(C)A	NT	78	86.7	95.8	1	126.0	4.8	5

Notes:

2. Color band denotes cathode on unidirectional devices only. No color band on bidirectional devices.
3. For bidirectional parts with $V_{RWM} < 10$ V, the I_R max limit is doubled.

Electrical Characteristics (Continued)Values are at $T_A = 25^\circ\text{C}$ unless otherwise noted.

Uni-Directional Bi-Directional (C) Device	Part Marking ⁽²⁾	Reverse Stand-Off Voltage V_{RWM} (V)	Breakdown Voltage V_{BR} (V)		Test Current I_T (mA)	Clamping Voltage at I_{PPM} V_C (V)	Peak Pulse Current I_{PPM} (A)	Reverse Leakage at V_{RWM} I_R (μA) ⁽³⁾
			Min.	Max.				
SMBJ85(C)A	NV	85	94.4	104.0	1	137.0	4.4	5
SMBJ90(C)A	NX	90	100.0	111.0	1	146.0	4.1	5
SMBJ100(C)A	NZ	100	111.0	123.0	1	162.0	3.7	5
SMBJ110(C)A	PE	110	122.0	135.0	1	177.0	3.4	5
SMBJ120(C)A	PG	120	133.0	147.0	1	193.0	3.1	5
SMBJ130(C)A	PK	130	144.0	159.0	1	209.0	2.9	5
SMBJ150(C)A	PM	150	167.0	185.0	1	243.0	2.5	5
SMBJ160(C)A	PP	160	178.0	197.0	1	259.0	2.3	5
SMBJ170(C)A	PR	170	189.0	209.0	1	275.0	2.2	5

Notes:

- Color band denotes cathode on unidirectional devices only. No color band on bidirectional devices.
- For bidirectional parts with $V_{RWM} < 10$ V, the I_R max limit is doubled.

Typical Performance Characteristics

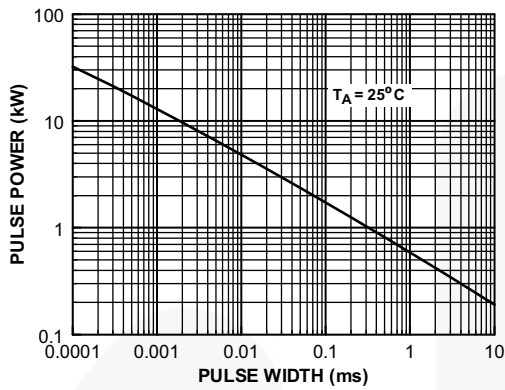

Figure 1. Peak Pulse Power Rating Curve



Figure 2. Pulse Derating Curve

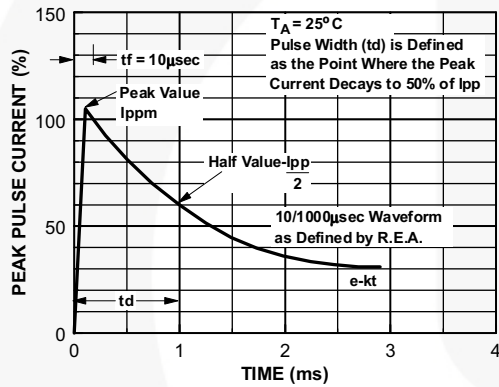

Figure 3. Pulse Waveform



Figure 4. Junction Capacitance



Figure 5. Non-Repetitive Surge Current

VP:SHOBY Φ ΟΑΒΑΡΡΑΔΙΙΙΟΟΥΥΑΙΟΚΩΣΦΟΒΑΜΤ ΘΕΡΟΝΟΥΙΙΙΟΙΙΙΟΟΒΕΡΒΗΒΗΑΜΙΟ
 VP:OOUΦΑΡΓΕΣΣΟΤ ΓΕΔΑΥΡΟΑΡΦΑΕΑΒΙΟΟΟΟΕΟΑΙΙΟΙΙΙΟΙΙΙΟΕΣΑΕΙΑΜΑΤ ΑΥΟΟ
 VU:ΑΒΕΦΟΦΑΜΟΤ ΘΕΡΟΝΟΥΙΙΙΟΙΙΙΟΒΗΒΗΑΒΙΙΟΙΙΙΟΑΥΑΙΟΟΚΩΝΩΟΦΑΦΟΠΕΑΥΤ ΦΥ
 Υ ΦΑΡΑΦΑΡΑΙΙΙΟΙΙΙΟΕΣΑΕΙΑΜΑΤ ΘΕΡΟΝΟΥΙΙΙΟΑΙΟΚΩΣΦΟΒΑΜΤ ΘΕΡΟΝΟΥΙΙΙΟΙΙΙΟ
 ΟΙΙΙΟΒΗΒΗΑΒΙΙΟΟΚΩΝΩΟΦΑΦΟΠΕΑΥΤ ΦΑΡΑΦΑΡΑΙΙΙΟΙΙΙΟΕΣΑΕΙΑΜΑΤ ΘΕΡΟΝΟΥΙΙΙΟ
 ΟΙΙΙΟΒΗΒΗΑΒΙΙΟΟΚΩΝΩΟΦΑΦΟΠΕΑΥΤ ΦΑΡΑΦΑΡΑΙΙΙΟΙΙΙΟΕΣΑΕΙΑΜΑΤ ΘΕΡΟΝΟΥΙΙΙΟ
 ΟΙΙΙΟΒΗΒΗΑΒΙΙΟΟΚΩΝΩΟΦΑΦΟΠΕΑΥΤ ΦΑΡΑΦΑΡΑΙΙΙΟΙΙΙΟΕΣΑΕΙΑΜΑΤ ΘΕΡΟΝΟΥΙΙΙΟ
 ΟΙΙΙΟΒΗΒΗΑΒΙΙΟΟΚΩΝΩΟΦΑΦΟΠΕΑΥΤ ΦΑΡΑΦΑΡΑΙΙΙΟΙΙΙΟΕΣΑΕΙΑΜΑΤ ΘΕΡΟΝΟΥΙΙΙΟ

ΎΟΧΩΦΒΨ			
ΡΟΨ	ΟΨΟΨΦΩΦ	ΟΨ/Ο	ΟΨΘΨΨ
F	ΨΟΨΑΨΟΨΑΨΨ	FJT αΨΓεΨ	ΨΟΨΑΨΨΨ

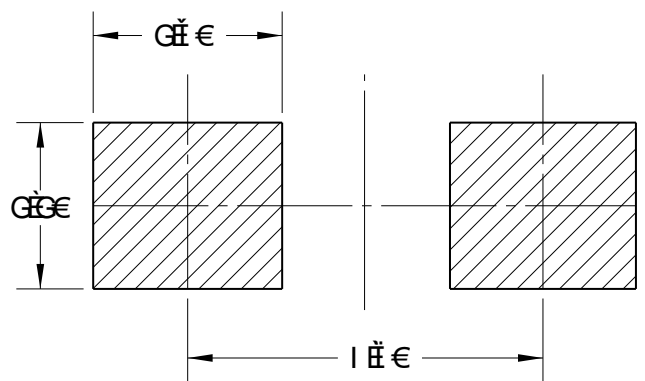
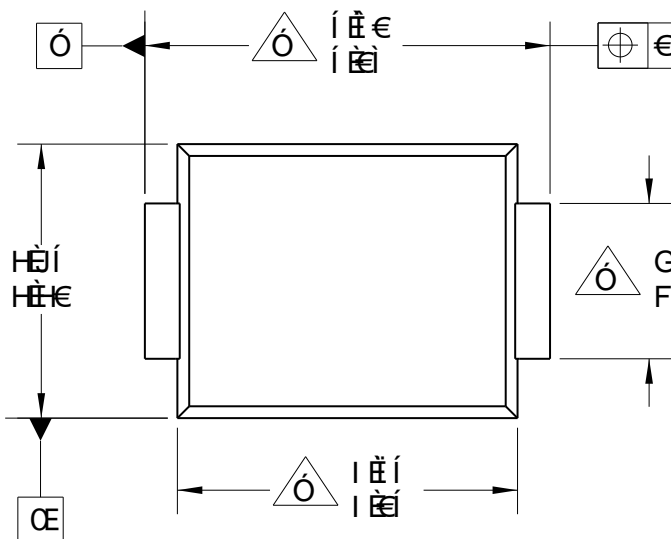

ΣΦΡΟΑΨΕΝΟΥΡΑΨΟΨΤ ΤΟΡΟΨΕΦ

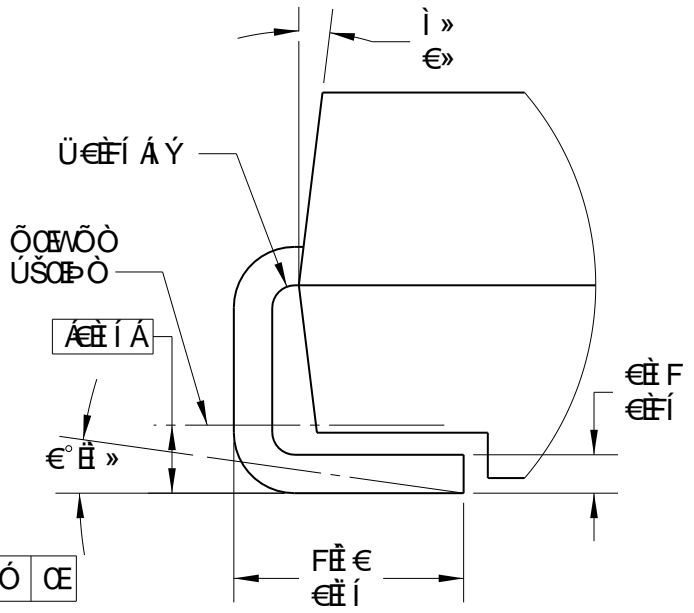
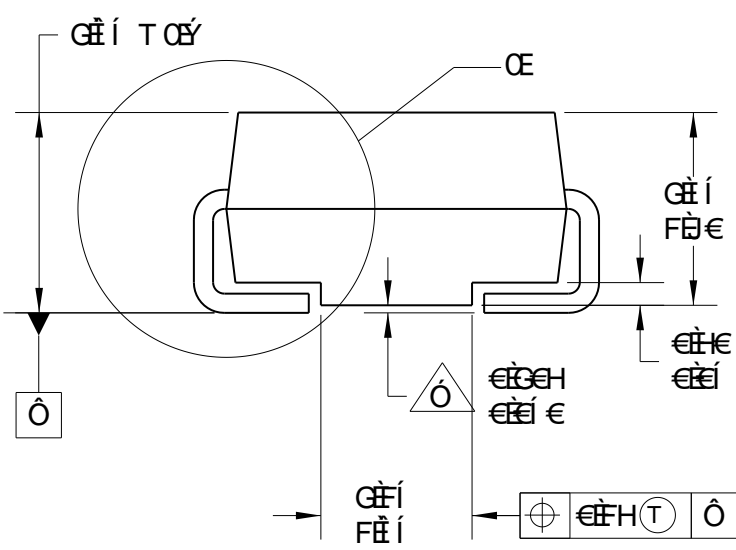

ΡΥΝΟΨΚ

ΑΨΕΨΟΨΟΥΑ ΡΟΨΟΑΡΥΝΟΨΟΨΡΑΨΤ ΨΑΨΑ
 ΡΟΨΟΨΟΨΓΦ ΑΨΕΨΕΦΨΑΨΕ
 Δ ΟΨΟΨΑΡΥΝΟΨ ΨΨΑΡΟΨΟΨΑΨΟΨΕ
 ΑΨΕΨΑΨΟΨΟΨΨΨΑΨΟΨΑΤ ΨΨΟΨΟΨΕ
 ΑΨΕΨΟΨΟΨΨΨΑΨΟΨΨΨΨΨΑΨΨΨΨΨ
 ΑΨΨΟΨΨΨΨΑΨΨΑΨΨΨΨΨΨΨΨΨΨΨΨΨ
 ΑΨΕΨΟΨΨΨΨΑΨΨΨΨΨΨΨΨΨΨΨΨΨΨΨ
 ΨΨΨΨΨΨΨΨΨΨΨΨΨΨΨΨΨΨΨΨΨΨΨ
 ΑΨΕΨΟΨΨΨΨΑΨΨΨΨΨΨΨΨΨΨΨΨΨΨΨ
 ΑΨΕΨΟΨΨΨΨΑΨΨΨΨΨΨΨΨΨΨΨΨΨΨΨ

ΨΨΨΨΨΨ	ΟΨ/Ο		ΓΨΕΨΤ ΟΑΡΟΨΟΨ ΟΨΓΦ ΑΨΕΨΕΦΨΑΨΕ							
ΟΨΨΨΨΨΨ	FJT αΨΓεΨ									
ΟΨΨΨΨΨΨ										
ΟΨΨΨΨΨΨ										
ΨΨΨΨΨΨ	ΨΨΨΨΨΨ	<table border="1"> <tr> <td>ΨΨΨΨ</td> <td>ΨΨΨΨ</td> <td>ΟΨΨΨΨΨΨ</td> <td>ΨΨΨ</td> </tr> <tr> <td>FJT</td> <td>ΨΨΨ</td> <td>ΨΨΨΨΨΨΨΨ</td> <td>F</td> </tr> </table>	ΨΨΨΨ	ΨΨΨΨ	ΟΨΨΨΨΨΨ	ΨΨΨ	FJT	ΨΨΨ	ΨΨΨΨΨΨΨΨ	F
ΨΨΨΨ	ΨΨΨΨ	ΟΨΨΨΨΨΨ	ΨΨΨ							
FJT	ΨΨΨ	ΨΨΨΨΨΨΨΨ	F							

ON Semiconductor and  are trademarks of Semiconductor Components Industries, LLC dba ON Semiconductor or its subsidiaries in the United States and/or other countries. ON Semiconductor owns the rights to a number of patents, trademarks, copyrights, trade secrets, and other intellectual property. A listing of ON Semiconductor's product/patent coverage may be accessed at www.onsemi.com/site/pdf/Patent-Marking.pdf. ON Semiconductor reserves the right to make changes without further notice to any products herein. ON Semiconductor makes no warranty, representation or guarantee regarding the suitability of its products for any particular purpose, nor does ON Semiconductor assume any liability arising out of the application or use of any product or circuit, and specifically disclaims any and all liability, including without limitation special, consequential or incidental damages. Buyer is responsible for its products and applications using ON Semiconductor products, including compliance with all laws, regulations and safety requirements or standards, regardless of any support or applications information provided by ON Semiconductor. "Typical" parameters which may be provided in ON Semiconductor data sheets and/or specifications can and do vary in different applications and actual performance may vary over time. All operating parameters, including "Typicals" must be validated for each customer application by customer's technical experts. ON Semiconductor does not convey any license under its patent rights nor the rights of others. ON Semiconductor products are not designed, intended, or authorized for use as a critical component in life support systems or any FDA Class 3 medical devices or medical devices with a same or similar classification in a foreign jurisdiction or any devices intended for implantation in the human body. Should Buyer purchase or use ON Semiconductor products for any such unintended or unauthorized application, Buyer shall indemnify and hold ON Semiconductor and its officers, employees, subsidiaries, affiliates, and distributors harmless against all claims, costs, damages, and expenses, and reasonable attorney fees arising out of, directly or indirectly, any claim of personal injury or death associated with such unintended or unauthorized use, even if such claim alleges that ON Semiconductor was negligent regarding the design or manufacture of the part. ON Semiconductor is an Equal Opportunity/Affirmative Action Employer. This literature is subject to all applicable copyright laws and is not for resale in any manner.

PUBLICATION ORDERING INFORMATION

LITERATURE FULFILLMENT:

Literature Distribution Center for ON Semiconductor
19521 E. 32nd Pkwy, Aurora, Colorado 80011 USA
Phone: 303-675-2175 or 800-344-3860 Toll Free USA/Canada
Fax: 303-675-2176 or 800-344-3867 Toll Free USA/Canada
Email: orderlit@onsemi.com

N. American Technical Support: 800-282-9855 Toll Free
USA/Canada
Europe, Middle East and Africa Technical Support:
Phone: 421 33 790 2910
Japan Customer Focus Center
Phone: 81-3-5817-1050

ON Semiconductor Website: www.onsemi.com
Order Literature: <http://www.onsemi.com/orderlit>
For additional information, please contact your local
Sales Representative

X-ON Electronics

Largest Supplier of Electrical and Electronic Components

Click to view similar products for [ESD Suppressors / TVS Diodes](#) category:

Click to view products by [ON Semiconductor](#) manufacturer:

Other Similar products are found below :

[60KS200C](#) [D12V0H1U2WS-7](#) [D18V0L1B2LP-7B](#) [82356050220](#) [D5V0M5U6V-7](#) [NTE4902](#) [P4KE27CA](#) [P6KE11CA](#) [P6KE39CA-TP](#)
[P6KE8.2A](#) [SA110CA](#) [SA60CA](#) [SA64CA](#) [SMBJ12CATR](#) [SMBJ8.0A](#) [SMLJ30CA-TP](#) [ESD101-B1-02ELS E6327](#) [ESD112-B1-02EL E6327](#)
[ESD119B1W01005E6327XTSA1](#) [ESD5V0J4-TP](#) [ESD5V0L1B02VH6327XTSA1](#) [ESD7451N2T5G](#) [19180-510](#) [CPDT-5V0USP-HF](#)
[3.0SMCJ33CA-F](#) [3.0SMCJ36A-F](#) [HSPC16701B02TP](#) [D3V3Q1B2DLP3-7](#) [D55V0M1B2WS-7](#) [DESD5V0U1BL-7B](#) [DRTR5V0U4SL-7](#)
[SCM1293A-04SO](#) [ESD200-B1-CSP0201 E6327](#) [ESD203-B1-02EL E6327](#) [SM12-7](#) [SMF8.0A-TP](#) [SMLJ45CA-TP](#) [CEN955 W/DATA](#)
[82350120560](#) [82356240030](#) [VESD12A1A-HD1-GS08](#) [CPDUR5V0R-HF](#) [CPDUR24V-HF](#) [CPDQC5V0U-HF](#) [CPDQC5V0USP-HF](#)
[CPDQC5V0-HF](#) [D1213A-01LP4-7B](#) [D1213A-02WL-7](#) [ESDLIN1524BJ-HQ](#) [5KP100A](#)