



ON Semiconductor®

<http://onsemi.com>

STK672-610

Thick-Film Hybrid IC

2-phase Stepping Motor Driver

Overview

The STK672-610 is a hybrid IC for use as a unipolar, 2-phase stepping motor driver with PWM current control.

Applications

- Office photocopiers, printers, etc.

Features

- The motor speed can be controlled by the frequency of an external clock signal.
- 2-phase excitation or 1-2 phase excitation is selected according to switching the state of the MODE1 pin (low or high).
- The excitation mode is set at the rising edge of the clock signal when the MODE2 pin is High, or at the rising edge or falling edge when the MODE2 pin is Low.
- The phase is maintained even if the excitation mode is switched in the middle of operation.
- The direction of rotation can be changed by applying a High or Low signal to the CWB pin used to select the direction of rotation.
- Supports schmitt input for 2.5V high level input.
- Incorporating a current detection resistor (0.089Ω: resistor tolerance $\pm 2\%$), motor current can be set using two external resistors.
- Equipped with an ENABLE pin that, during clock input, allows motor output to be cut-off and resumed later while maintaining the same excitation timing.

STK672-610

Specifications

Absolute Maximum Ratings at $T_c = 25^\circ\text{C}$

Parameter	Symbol	Conditions	Ratings	unit
Maximum supply voltage 1	V_{CC} max	No signal	52	V
Maximum supply voltage 2	V_{DD} max	No signal	-0.3 to +7.0	V
Input voltage	V_{IN} max	Logic input pins	-0.3 to +7.0	V
Output current	I_{OH} max	$V_{DD}=5\text{V}$, $\text{CLOCK}\geq 200\text{Hz}$	4.0	A
Allowable power dissipation 1	P_{dMF} max	With an arbitrarily large heat sink. Per MOSFET	10.2	W
Allowable power dissipation 2	P_{dPK} max	No heat sink	3.1	W
Operating substrate temperature	T_c max		105	$^\circ\text{C}$
Junction temperature	T_j max		150	$^\circ\text{C}$
Storage temperature	T_{stg}		-40 to +125	$^\circ\text{C}$

Stresses exceeding Maximum Ratings may damage the device. Maximum Ratings are stress ratings only. Functional operation above the Recommended Operating Conditions is not implied. Extended exposure to stresses above the Recommended Operating Conditions may affect device reliability.

Allowable Operating Ranges at $T_a = 25^\circ\text{C}$

Parameter	Symbol	Conditions	Ratings	unit
Operating supply voltage 1	V_{CC}	With signals applied	10 to 42	V
Operating supply voltage 2	V_{DD}	With signals applied	$5\pm 5\%$	V
Input high voltage	V_{IH}	Pins 10, 12, 13, 14, 15, 17	2.5 to V_{DD}	V
Input low voltage	V_{IL}	Pins 10, 12, 13, 14, 15, 17	0 to 0.6	V
Output current 1	I_{OH1}	$T_c=105^\circ\text{C}$, $\text{CLOCK}\geq 200\text{Hz}$, Continuous operation, duty=100%	3.0	A
Output current 2	I_{OH2}	$T_c=80^\circ\text{C}$, $\text{CLOCK}\geq 200\text{Hz}$, Continuous operation, duty=100%, See the motor current (I_{OH}) derating curve	3.3	A
CLOCK frequency	f_{CL}	Minimum pulse width: at least $10\mu\text{s}$	0 to 50	kHz
Phase driver withstand voltage	V_{DSS}	$I_D=1\text{mA}$ ($T_c=25^\circ\text{C}$)	100min	V
Recommended operating substrate temperature	T_c	No condensation	0 to 105	$^\circ\text{C}$
Recommended V_{ref} range	V_{ref}	$T_c=105^\circ\text{C}$	0.14 to 1.31	V

Refer to the graph for each conduction-period tolerance range for the output current and brake current.

Electrical Characteristics at $T_c = 25^\circ\text{C}$, $V_{CC} = 24\text{V}$, $V_{DD} = 5.0\text{V}$

Parameter	Symbol	Conditions	min	typ	max	unit
V_{DD} supply current	I_{CCO}	Pin 9 current $\text{CLOCK}=\text{GND}$		5.0	9	mA
Output average current	I_{oave}	$R/L=1\Omega/0.62\text{mH}$ in each phase	0.629	0.694	0.768	A
FET diode forward voltage	V_{df}	$I_f=1\text{A}$ ($R_L=23\Omega$)		1.0	1.6	V
Output saturation voltage	V_{sat}	$R_L=23\Omega$		0.26	0.38	V
Input leak current	I_{IL}	Pins 10, 12, 13, 14, 15, 17 $=\text{GND}$ and 5V			± 10	μA
V_{ref} input bias current	I_{IB}	Pin 19 =1.0V		204	216	μA
PWM frequency	f_c		35	45	56	kHz

* I_{oave} values are for when the lead frame of the product is soldered to the mounting substrate.

Notes: A fixed-voltage power supply must be used.

STK672-610

Package Dimensions

unit:mm (typ)

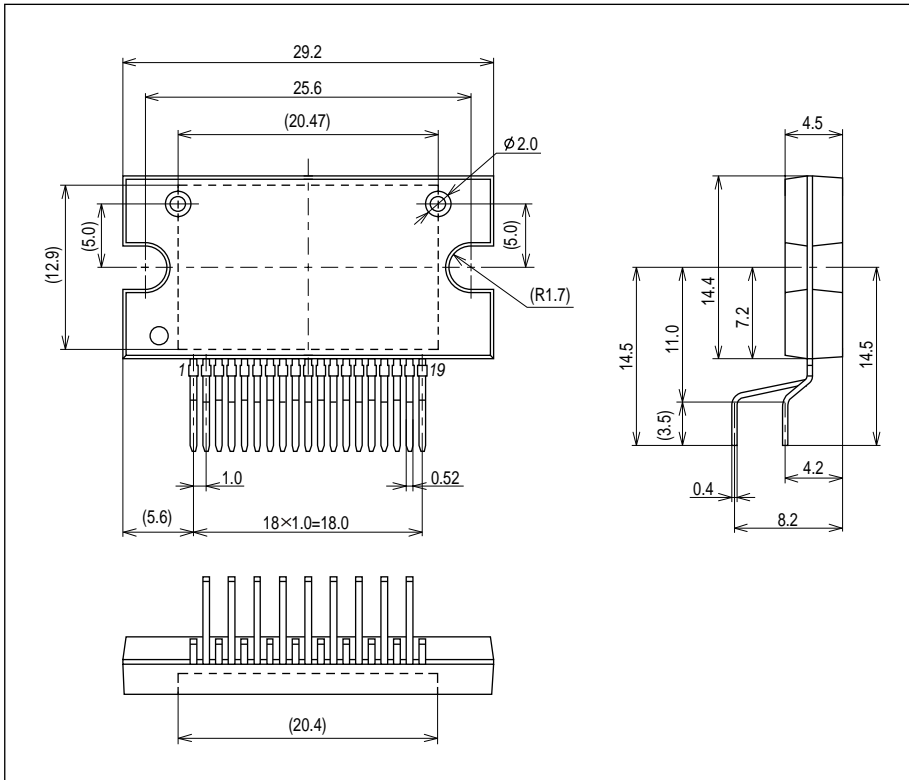

Derating curve of motor current, I_{OH} , vs. STK672-610 Operating substrate temperature, T_c

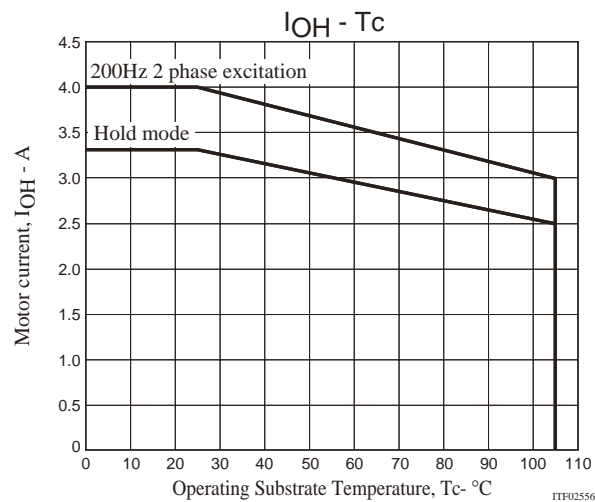

Notes

- The current range given above represents conditions when output voltage is not in the avalanche state.
- If the output voltage is in the avalanche state, see the allowable avalanche energy for STK672-6** series hybrid ICs given in a separate document.
- The operating substrate temperature, T_c , given above is measured while the motor is operating. Because T_c varies depending on the ambient temperature, T_a , the value of I_{OH} , and the continuous or intermittent operation of I_{OH} , always verify this value using an actual set.

Block Diagram

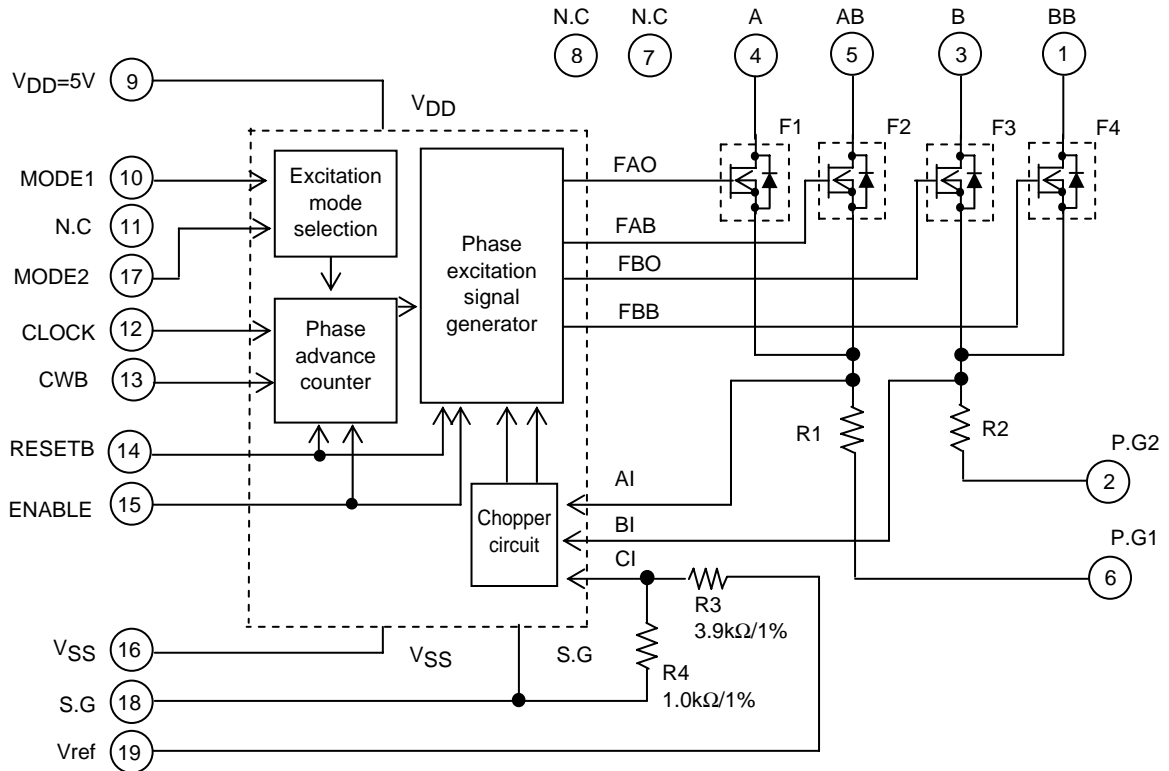

Sample Application Circuit

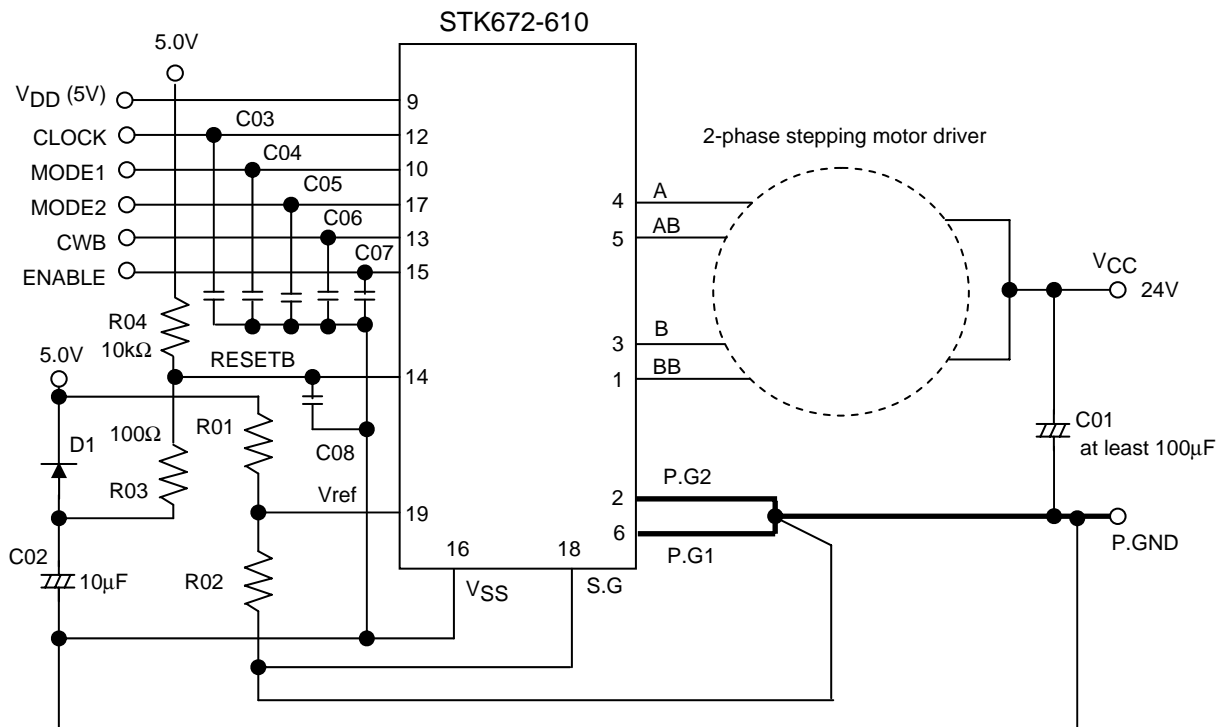

*: C03 through C08 represents a capacitor recommended for use with a recommended value of 1,000pF.

Precautions

[Damage to the internal MOSFET]

- The RESETB pin must be fixed low when applying 5V power. If the RESETB pin is allowed to go high at the same time as the 5V power, simultaneous ON of the output phase will result, causing damage to the internal MOSFET.

[GND wiring]

- To reduce noise on the 5V system, be sure to place the GND of C01 in the circuit given above as close as possible to Pin 2 and Pin 6 of the hybrid IC. Also, to achieve accurate current settings, be sure to connect Vref GND to Pin 18 (S.G) used to set the current and to the point where P.G1 and P.G2 share a connection.
- If the driver region VSS pin (Pin 16), S.G pin (Pin 18), P.G1 pin (Pin 2), and P.G2 pin (Pin 6) cannot be connected to a single ground, make sure to connect the VSS pin to the control system S.GND, and the S.G pin to the P.G1 pin and P.G2 pin.

[Input pins]

- If VDD is not being applied to the hybrid IC, do not apply voltage to input Pins 10, 12, 13, 14, 15, or 17. In addition, if VDD is being applied, use care that each input pin does not apply a negative voltage less than -0.3V to VSS, Pin 16, and do not apply a voltage greater than or equal to VDD voltage.
- Do not wire by connecting the circuit pattern on the P.C.B side to Pins 7, 8, or 11 on the N.C. shown in the internal block diagram.
- Insert resistor RO3 (47 to 100Ω) so that the discharge energy from capacitor CO4 is not directly applied to the CMOS IC in this hybrid device. If the diode D1 has Vf characteristics with Vf less than or equal to 0.6V (when If = 0.1A), this will be smaller than the CMOS IC input pin diode Vf. If this is the case RO3 may be replaced with a short without problem.
- Both TTL and CMOS levels are used for the pin 10, 12, 13, 15 and 17 inputs.
- Since the input pins do not have built-in pull-up resistors, when the open-collector type pins 10, 12, 13, 15, and 17 are used as inputs, a 1 to 15kΩ pull-up resistor (to VDD) must be used.
At this time, use a device for the open collector driver that has output current specifications that pull the voltage down to less than 0.6V at Low level (less than 0.6V at Low level when IOL=5mA).
- If input pins are connected to GND (VSS) using a pull-down resistor, be sure to mount a resistor having a resistance of 120Ω or less. If designs call for a pull-down resistor having a resistance in the range 120Ω to 30kΩ, be absolutely sure to mount a 1,000pF capacitor between the input pins and the VSS Pin. Because sufficient VIL cannot be maintained due to the effect of input leak current, IIL=±10μA max, do not connect a pull-down resistor having a resistance of 30kΩ or higher.
- The sample application circuit includes a simple reset circuit using D1, R03, C02, and R04. If 5V power rises while voltage still remains in C02, the reset signal cannot be detected as LOW and the driver may be damaged because ON operations result at the same time that driver output is in A or AB phase or B or BB phase. The voltage of C02 must therefore be less than 0.6V when the 5V power rises.
In addition, if a RESETB signal is to be input based on an external signal such as the CLOCK signal, RESETB must always be fixed to a Low level when the 5V power signal rises.
- To prevent malfunction due to chopping noise, we recommend that you mount a 1000pF capacitor between Pin 16 and each of the input Pins 10, 12, 13, 14, 15, and 17. Be sure to mount the capacitor as close as possible to the pins of hybrid IC.
If input is fixed Low, directly connect to Pin 16.
If input is fixed High, directly connect to the 5V power line.

[Current setting Vref]

- Considering the specifications of the Vref input bias current, IIB, a value of 1kΩ or less is recommended for R02.
- If the motor current is temporarily reduced, the circuit given below (STK672-600: IOH>0.2A, STK672-610: IOH>0.3A) is recommended.
- Although the driver is equipped with a fixed current control function, it is not equipped with an overcurrent protection function to ensure that the current does not exceed the maximum output current, IOH max. If Vref is mistakenly set to a voltage that exceeds IOH max, the driver will be damaged by overcurrent.

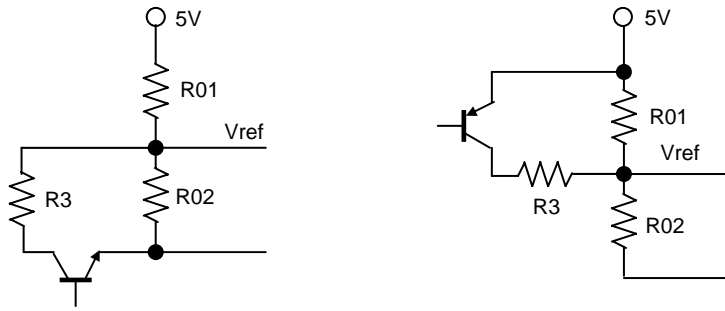

- Motor current peak value I_{OH} setting

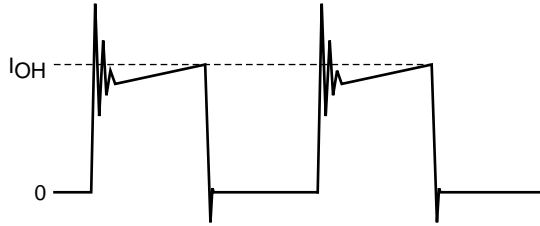

- When R02 is open

$$I_{OH} = [V_{ref} \times 1k / (1k + 3.9k)] \div R_s = (V_{ref} \div 4.9) \div R_s$$

The values 1k and 3.9k represent internal driver resistance values, while R_s represents the internal driver current detection resistance.

$$V_{ref} = (4.9k \div (4.9k + R_{01})) \times 5V \text{ (or } 3.3V) = I_{OH} \times 4.9 \times R_s$$

The value 4.9k represents the series resistance value of the internal driver values of 1k and 3.9k.

- If R02 is connected

$$I_{OH} = [V_{ref} \times 1k / (1k + 3.9k)] \div R_s = (V_{ref} \div 4.9) \div R_s$$

The values 1k and 3.9k represent the internal driver resistance values, while R_s represents the internal driver current detection resistance.

$$V_{ref} = (R_{0x} \div (R_{01} + R_{0x})) \times 5V \text{ (or } 3.3V) = I_{OH} \times 4.9 \times R_s$$

$$= [(4.9k \times R_{02}) \div ((4.9k \times R_{02}) + R_{01} \times (4.9k + R_{02}))] \times 5V \text{ (or } 3.3V)$$

$$R_{0x} = (4.9k \times R_{02}) \div (4.9k + R_{02})$$

R_s represents the current detection resistance inside the HIC, while the value 4.9k in the formula above represents the internal resistance value of the Vref pin.

$$R_s = 0.141\Omega \text{ when using the STK672-600}$$

$$R_s = 0.089\Omega \text{ when using the STK672-610}$$

Input Pin Functions

Pin Name	Pin No.	Function	Input Conditions When Operating
CLOCK	12	Reference clock for motor phase current switching	Operates on the rising edge of the signal (MODE2=H)
MODE1	10	Excitation mode selection	Low: 2-phase excitation High: 1-2 phase excitation
MODE2	17		High: Rising edge Low: Rising and falling edge
CWB	13	Motor direction switching	Low: CW (forward) High: CCW (reverse)
RESETB	14	System reset and A, AB, B, and BB outputs cutoff. Applications must apply a reset signal for at least 10μs when V_{DD} is first applied.	A reset is applied by a low level
ENABLE	15	The A, AB, B, and BB outputs are turned off, and after operation is restored by returning the ENABLE pin to the high level, operation continues with the same excitation timing as before the low-level input.	The A, AB, B, and BB outputs are turned off by a low-level input.

- (1) A simple reset function is formed from D1, CO4, RO3, and RO4 in this application circuit. With the CLOCK input held low, when the 5V supply voltage is brought up a reset is applied if the motor output phases A and BB are driven. If the 5V supply voltage rise time is slow (over 50ms), the motor output phases A and BB may not be driven. Increase the value of the capacitor CO2 and check circuit operation again.
- (2) See the timing chart for the concrete details on circuit operation.

Timing Charts

2-phase excitation

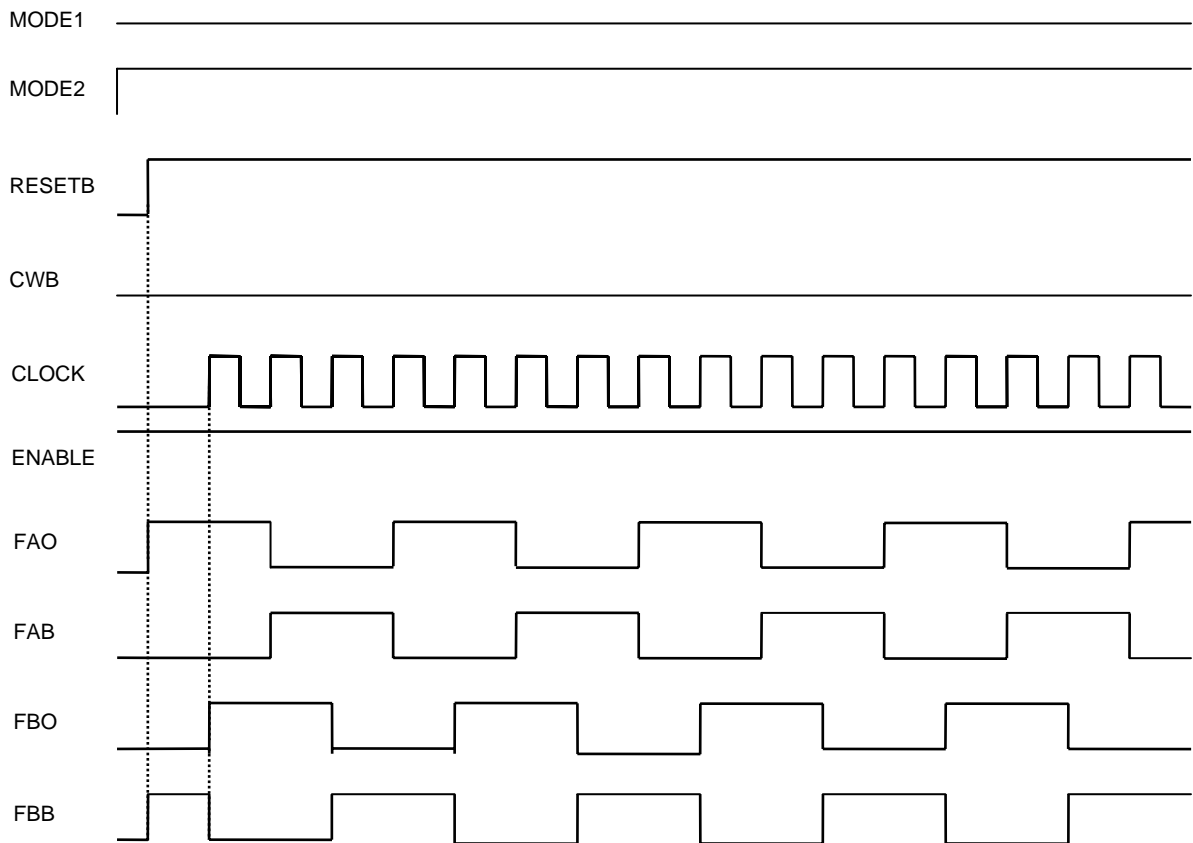

1-2 phase excitation

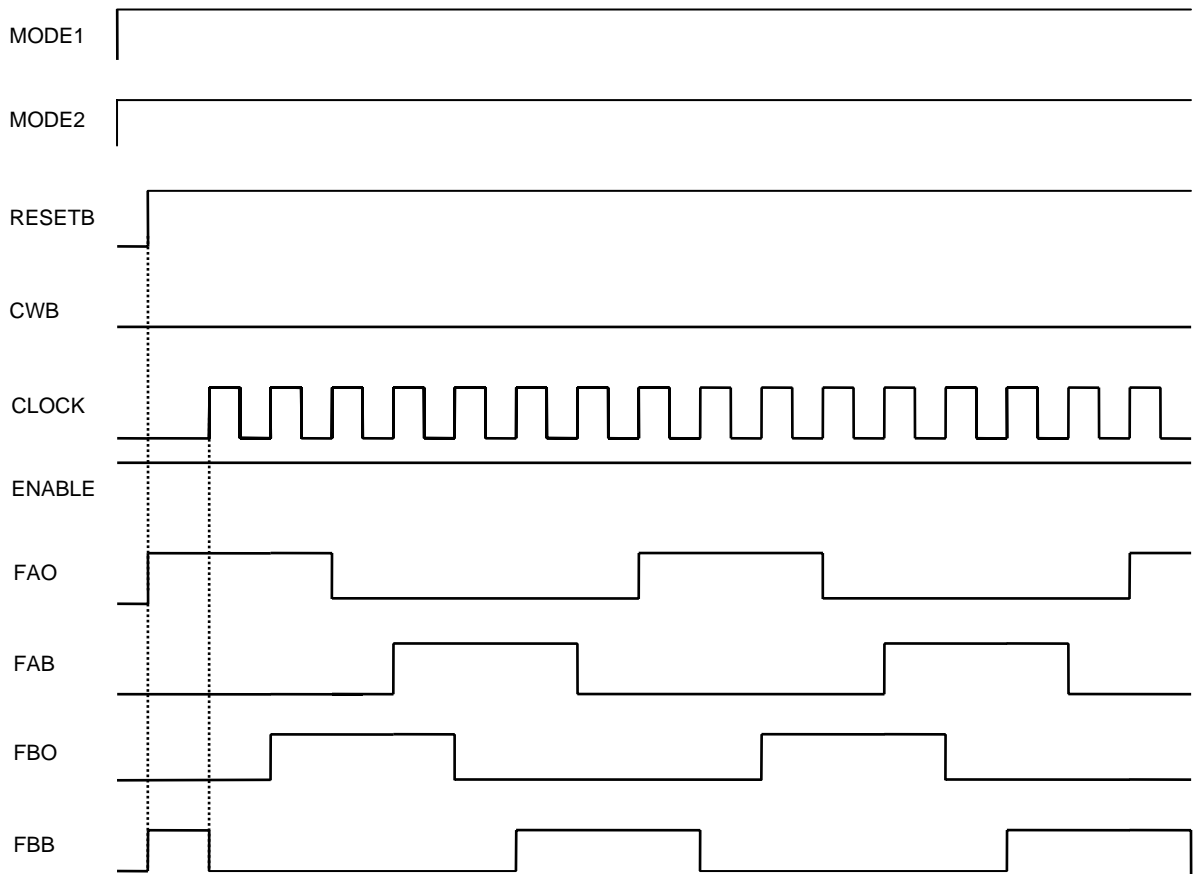

1-2 phase excitation (ENABLE)

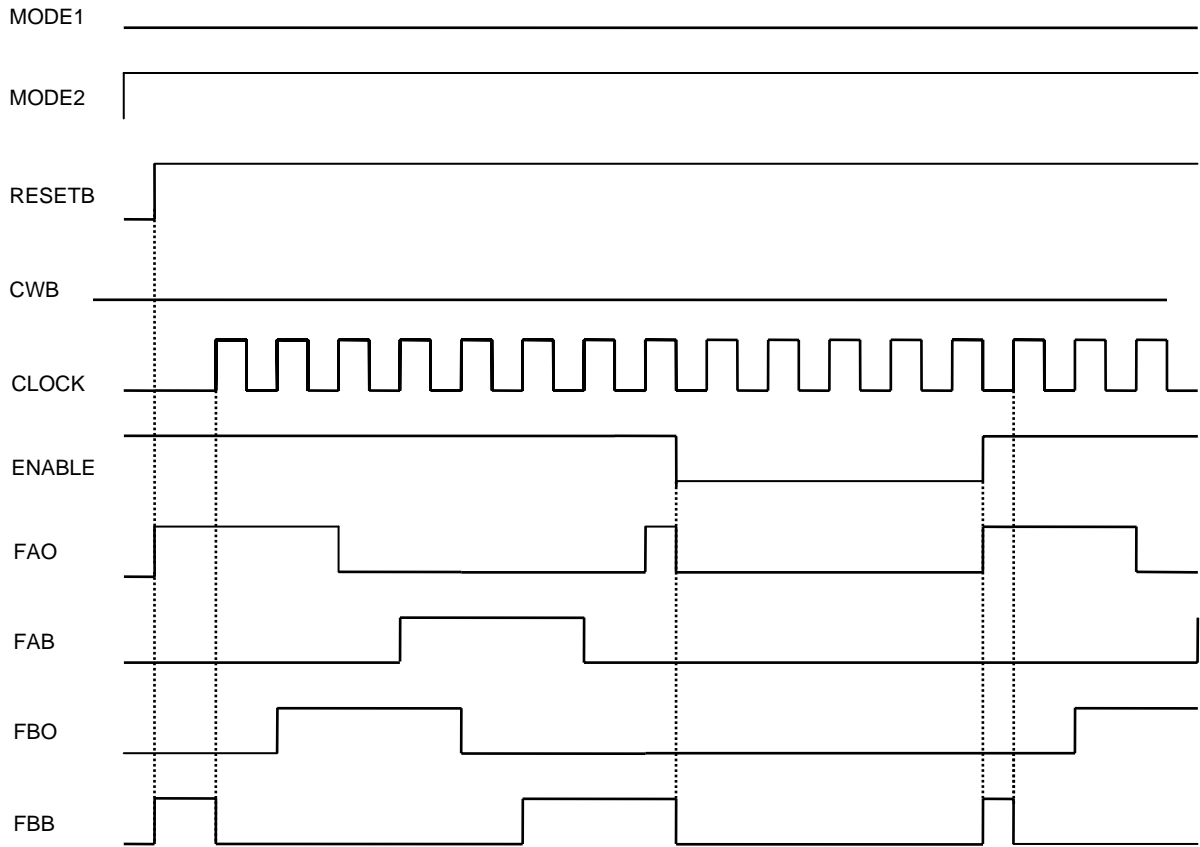

1-2 phase excitation (Hold operation results during fixed CLOCK)

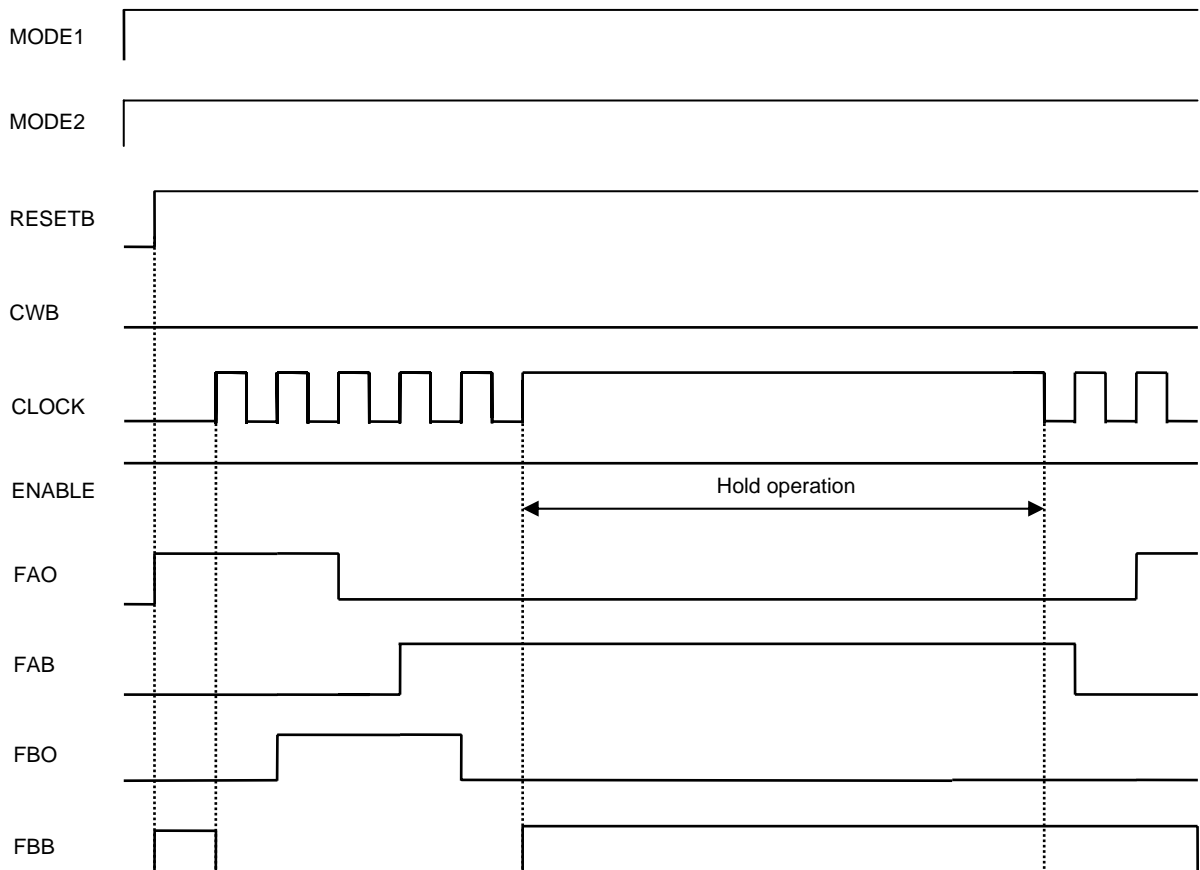

STK672-610

2-phase excitation (MODE2)

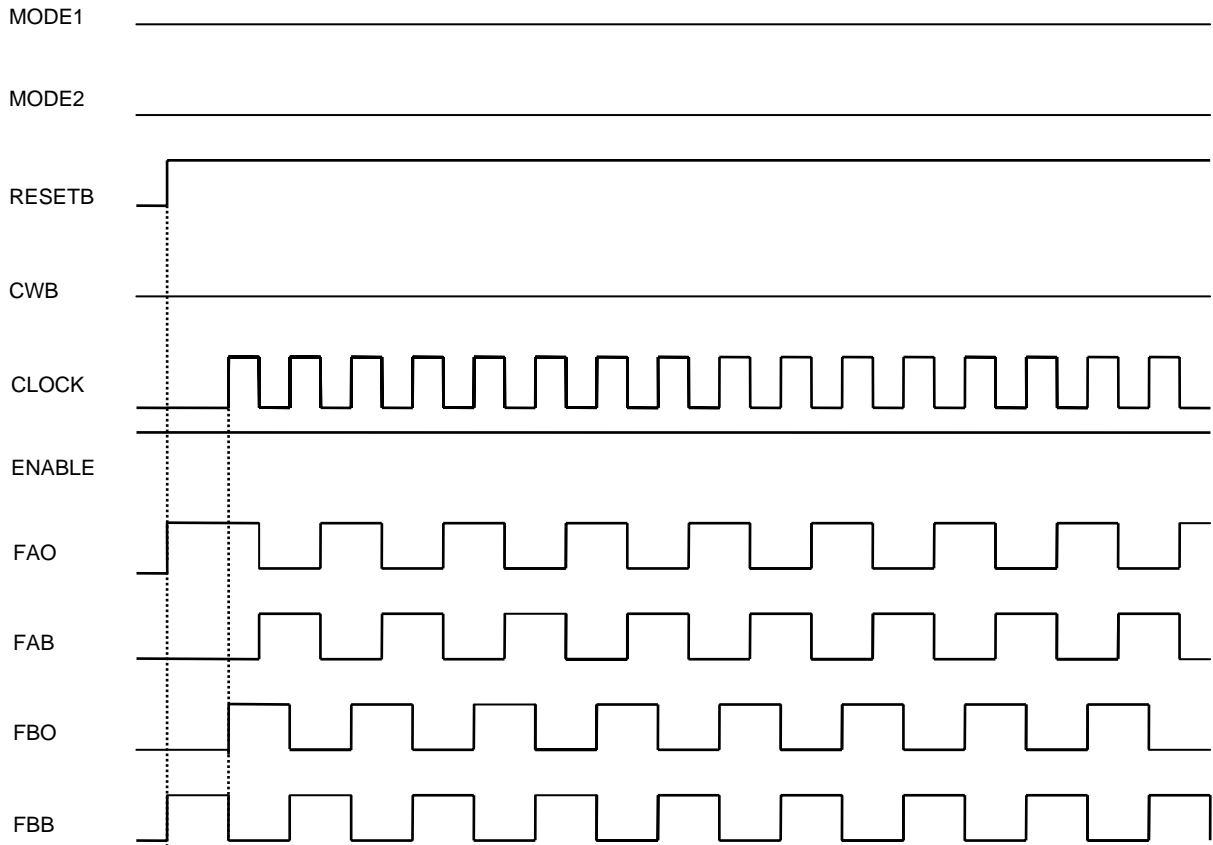

1-2 phase excitation (MODE2)

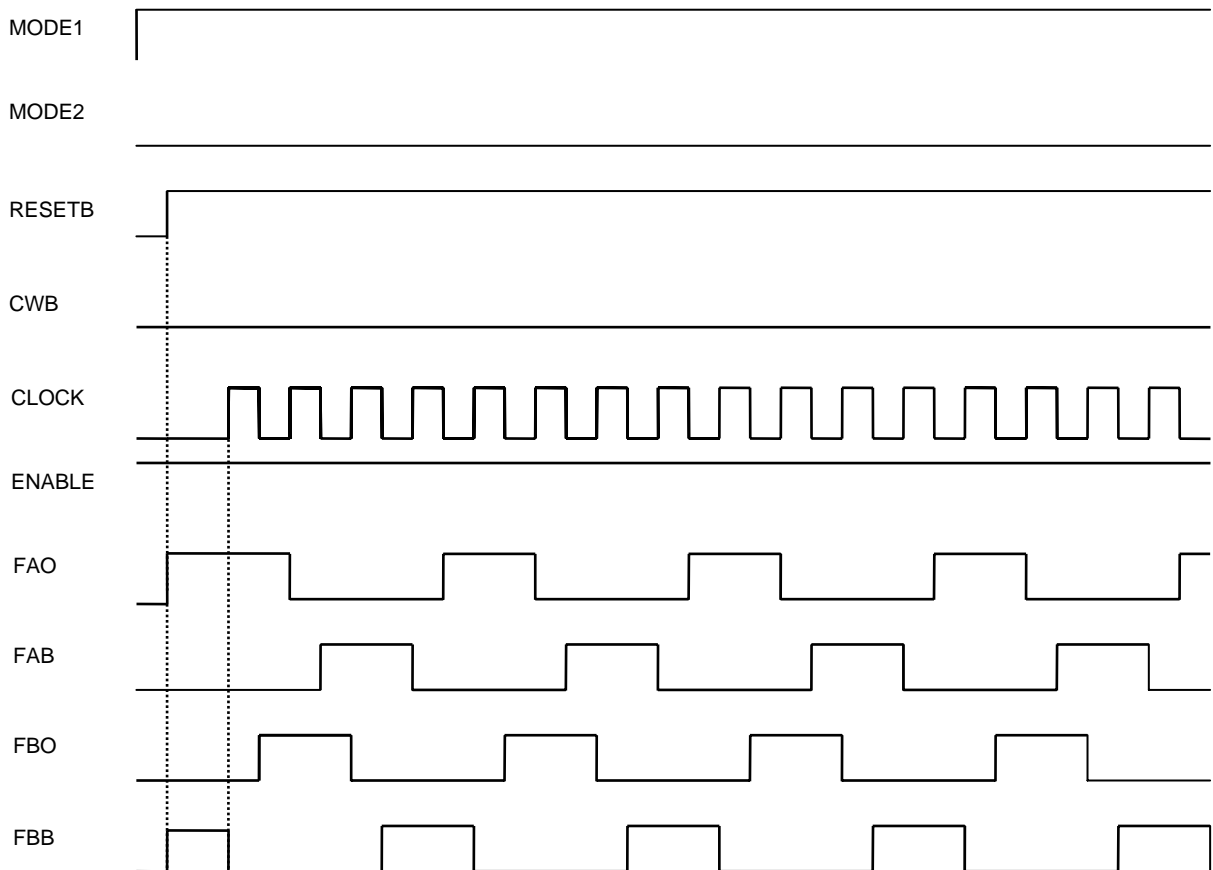

Usage Notes

1. STK672-600 and STK672-610 input signal functions and timing

(All inputs have no internal pull-up resistor and are TTL level Schmitt trigger inputs.)

[RESETB and CLOCK (Input signal timing when power is first applied)]

As shown in the timing chart, a RESETB signal input is required by the driver to operate with the timing in which the F1 gate is turned on first. The RESETB signal timing must be set up to have a width of at least 10 μ s, as shown below. The capacitor CO2, and the resistors RO3 and RO4 in the application circuit form simple reset circuit that uses the RC time constant rising time. However, when designing the RESETB input based on V_{IH} levels, the application must have the timing shown in figure.

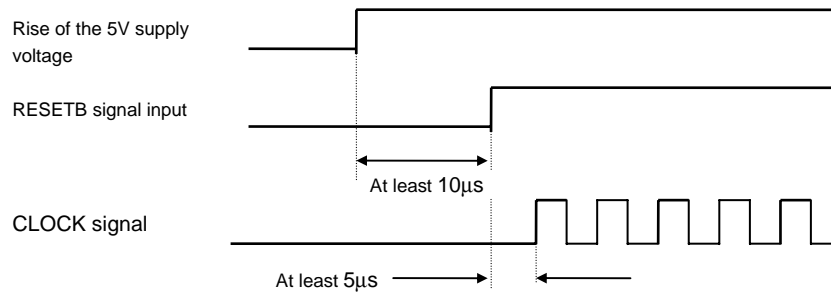

RESETB and CLOCK Signals Input Timing

[CLOCK (Phase switching clock)]

- Input frequency: DC to 50kHz
- Minimum pulse width: 10 μ s
- MODE2=1(High) Signals are read on the rising edge.
- MODE2=0(Low) Signals are read on the rising and falling edges.

[CWB (Motor direction setting)]

The direction of rotation is switched by setting CWB to 1 (high) or 0 (low). See the timing charts for details on the operation of the outputs.

Note: The state of the CWB input must not be changed during the 6.25 μ s period before and after the rising edge of the CLOCK input.

[ENABLE (Forcible on/off control of the A, AB, B, and BB outputs, and hybrid IC internal operation)]

ENABLE=1: Normal operation

ENABLE=0: Outputs A, AB, B, and BB forced to the off state.

If, during the state where CLOCK signal input is provided, the ENABLE pin is set to 0 and then is later restored to the 1 state, the IC will resume operation with the excitation timing continued from before the point ENABLE was set to 0.

If sudden stop is applied to the CLOCK signal used for motor rotation, the motor axis may advance beyond the theoretical position due to inertia. To stop at the theoretical position, the SLOW DOWN setting for gradually slowing the CLOCK cycle is required.

Enable must be initially set high for input as shown in the timing chart.

[MODE1 and MODE2 (Excitation mode selection)]

MODE1=0: 2-phase excitation

MODE2=1: Rising edge of CLOCK

MODE1=1: 1-2 phase excitation

MODE2=0: Rising and falling edges of CLOCK

See the timing charts for details on output operation in these modes.

Note: The state of the MODE input must not be changed during the 5 μ s period before and after the rising edge of the CLOCK input.

2. Calculating STK672-610 HIC Internal Power Loss

The average internal power loss in each excitation mode of the STK672-610 can be calculated from the following formulas.

Each excitation mode

2-phase excitation mode

$$2PdAV_{ex} = (V_{sat} + V_{df}) \times 0.5 \times \text{CLOCK} \times I_{OH} \times t_2 + 0.5 \times \text{CLOCK} \times I_{OH} \times (V_{sat} \times t_1 + V_{df} \times t_3)$$

1-2 Phase excitation mode

$$1-2PdAV_{ex} = (V_{sat} + V_{df}) \times 0.25 \times \text{CLOCK} \times I_{OH} \times t_2 + 0.25 \times \text{CLOCK} \times I_{OH} \times (V_{sat} \times t_1 + V_{df} \times t_3)$$

Motor hold mode

$$\text{HoldPdAV}_{ex} = (V_{sat} + V_{df}) \times I_{OH}$$

V_{sat} : Combined voltage represented by the R_{on} voltage drop+ shunt resistor

V_{df} : Combined voltage represented by the MOSFET body diode+shunt resistor

CLOCK: Input CLOCK (CLOCK pin signal frequency)

t_1 , t_2 , and t_3 represent the waveforms shown in the figure below.

t_1 : Time required for the winding current to reach the set current (I_{OH})

t_2 : Time in the constant current control (PWM) region

t_3 : Time from end of phase input signal until inverse current regeneration is complete

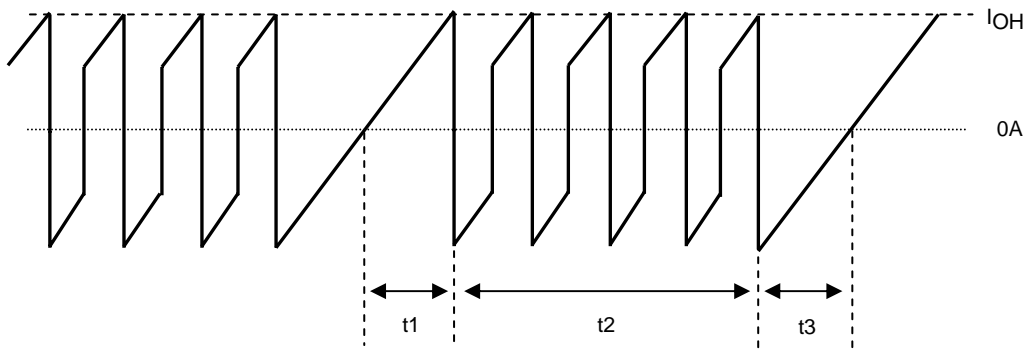

Motor COM Current Waveform Model

$$t_1 = (-L / (R + 0.26)) \ln (1 - ((R + 0.26) / V_{CC}) \times I_{OH})$$

$$t_3 = (-L / R) \ln ((V_{CC} + 0.42) / (I_{OH} \times R + V_{CC} + 0.42))$$

V_{CC} : Motor supply voltage (V)

L : Motor inductance (H)

R : Motor winding resistance (Ω)

I_{OH} : Motor set output current crest value (A)

Relationship of CLOCK, t_1 , t_2 , and t_3 in each excitation mode

2-phase excitation mode: $t_2 = (2 / \text{CLOCK}) - (t_1 + t_3)$

1-2 phase excitation mode: $t_2 = (3 / \text{CLOCK}) - t_1$

For V_{sat} and V_{df} , be sure to substitute values from the graphs of V_{sat} vs. I_{OH} and V_{df} vs. I_{OH} while the set current value is I_{OH} .

Then, determine whether a heat sink is required by comparing with the graph of ΔT_c vs. P_d based on the average HIC power loss calculated.

When designing a heat sink, refer to the section “Thermal design” found on the next page. The average HIC power loss, P_dAV , described above does not have the avalanche’s loss. To include the avalanche’s loss, be sure to add Equation (2), “STK676-6** Allowable Avalanche Energy Value” to P_dAV above. When using this IC without a fin always check for temperature increases in the set, because the HIC substrate temperature, T_c , varies due to effects of convection around the HIC.

STK672-610

STK672-610 Output saturation voltage, V_{sat} - Output current, I_{OH}

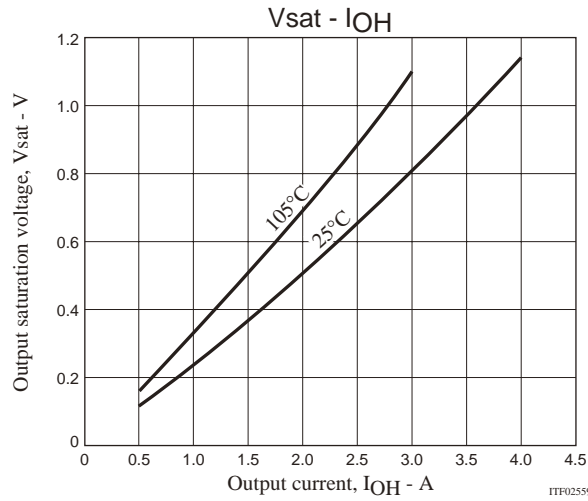

STK672-610 Forward voltage, V_{df} - Output current, I_{OH}

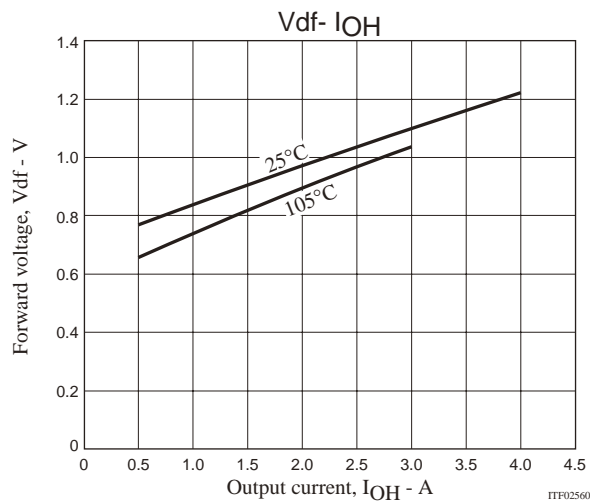

Substrate temperature rise, ΔT_c (no heat sink) - Internal average power dissipation, P_{dAV}

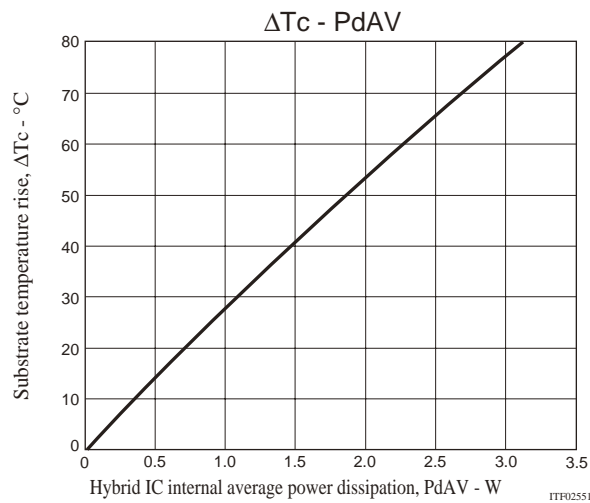

3. STK672-610 Allowable Avalanche Energy Value

(1) Allowable Range in Avalanche Mode

When driving a 2-phase stepping motor with constant current chopping using an STK672-6** Series hybrid IC, the waveforms shown in Figure 1 below result for the output current, I_D , and voltage, V_{DS} .

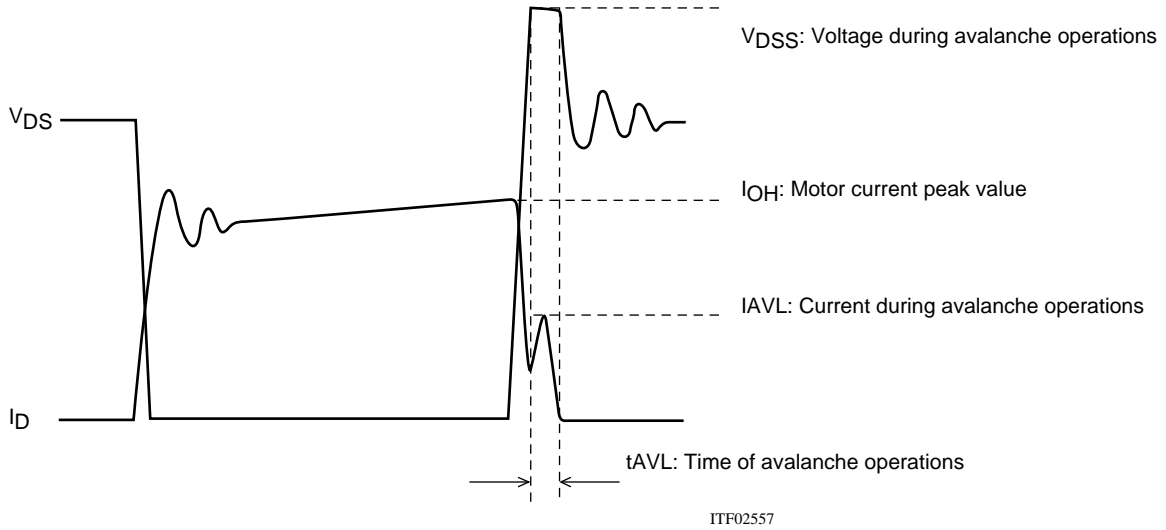

Figure 1 Output Current, I_D , and Voltage, V_{DS} , Waveforms 1 of the STK672-6** Series when Driving a 2-Phase Stepping Motor with Constant Current Chopping

When operations of the MOSFET built into STK672-6** Series ICs is turned off for constant current chopping, the I_D signal falls like the waveform shown in the figure above. At this time, the output voltage, V_{DS} , suddenly rises due to electromagnetic induction generated by the motor coil.

In the case of voltage that rises suddenly, voltage is restricted by the MOSFET V_{DSS} . Voltage restriction by V_{DSS} results in a MOSFET avalanche. During avalanche operations, I_D flows and the instantaneous energy at this time, E_{AVL1} , is represented by Equation (1).

$$E_{AVL1} = V_{DSS} \times I_{AVL} \times 0.5 \times t_{AVL} \text{ ----- (1)}$$

V_{DSS} : V units, I_{AVL} : A units, t_{AVL} : sec units

The coefficient 0.5 in Equation (1) is a constant required to convert the I_{AVL} triangle wave to a square wave.

During STK672-6** Series operations, the waveforms in the figure above repeat due to the constant current chopping operation. The allowable avalanche energy, E_{AVL} , is therefore represented by Equation (2) used to find the average power loss, P_{AVL} , during avalanche mode multiplied by the chopping frequency in Equation (1).

$$P_{AVL} = V_{DSS} \times I_{AVL} \times 0.5 \times t_{AVL} \times f_c \text{ ----- (2)}$$

f_c : Hz units (f_c is set to the PWM frequency of 50kHz.)

For V_{DSS} , I_{AVL} , and t_{AVL} , be sure to actually operate the STK672-6** Series and substitute values when operations are observed using an oscilloscope.

Ex. If $V_{DSS}=110V$, $I_{AVL}=1A$, $t_{AVL}=0.2\mu s$ when using a STK672-610 driver, the result is:

$$P_{AVL} = 110 \times 1 \times 0.5 \times 0.2 \times 10^{-6} \times 50 \times 10^3 = 0.55W$$

$V_{DSS}=110V$ is a value actually measured using an oscilloscope.

The allowable loss range for the allowable avalanche energy value, P_{AVL} , is shown in the graph in Figure 3. When examining the avalanche energy, be sure to actually drive a motor and observe the I_D , V_{DS} , and t_{AVL} waveforms during operation, and then check that the result of calculating Equation (2) falls within the allowable range for avalanche operations.

(2) I_D and V_{DS} Operating Waveforms in Non-avalanche Mode

Although the waveforms during avalanche mode are given in Figure 1, sometimes an avalanche does not result during actual operations.

Factors causing avalanche are listed below.

- Poor coupling of the motor's phase coils (electromagnetic coupling of A phase and AB phase, B phase and BB phase).
- Increase in the lead inductance of the harness caused by the circuit pattern of the P.C. board and motor.
- Increases in V_{DSS} , t_{AVL} , and I_{AVL} in Figure 1 due to an increase in the supply voltage from 24V to 36V.

If the factors above are negligible, the waveforms shown in Figure 1 become waveforms without avalanche as shown in Figure 2.

Under operations shown in Figure 2, avalanche does not occur and there is no need to consider the allowable loss range of $PAVL$ shown in Figure 3.

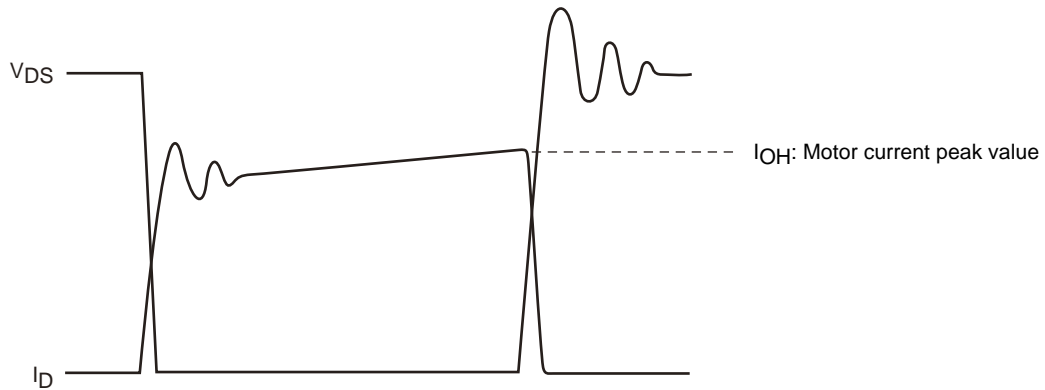

ITF02558

Figure 2 Output Current, I_D , and Voltage, V_{DS} , Waveforms 2 of the STK672-6** Series when Driving a 2-Phase Stepping Motor with Constant Current Chopping

Figure 3 Allowable Loss Range, $PAVL-I_{OH}$ During STK672-610 Avalanche Operations

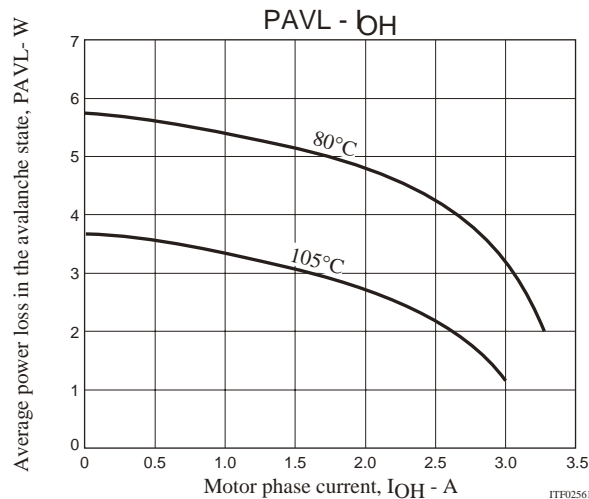

ITF02561

Note:

The operating conditions given above represent a loss when driving a 2-phase stepping motor with constant current chopping.

Because it is possible to apply 3.7W or more at $I_{OH}=0A$, be sure to avoid using the MOSFET body diode that is used to drive the motor as a zener diode.

4. Thermal design

[Operating range in which a heat sink is not used]

Use of a heat sink to lower the operating substrate temperature of the HIC (Hybrid IC) is effective in increasing the quality of the HIC.

The size of heat sink for the HIC varies depending on the magnitude of the average power loss, PdAV, within the HIC. The value of PdAV increases as the output current increases. To calculate PdAV, refer to “Calculating Internal HIC Loss for the STK672-600 and STK672-610” in the specification document.

Calculate the internal HIC loss, PdAV, assuming repeat operation such as shown in Figure 1 below, since conduction during motor rotation and off time both exist during actual motor operations,

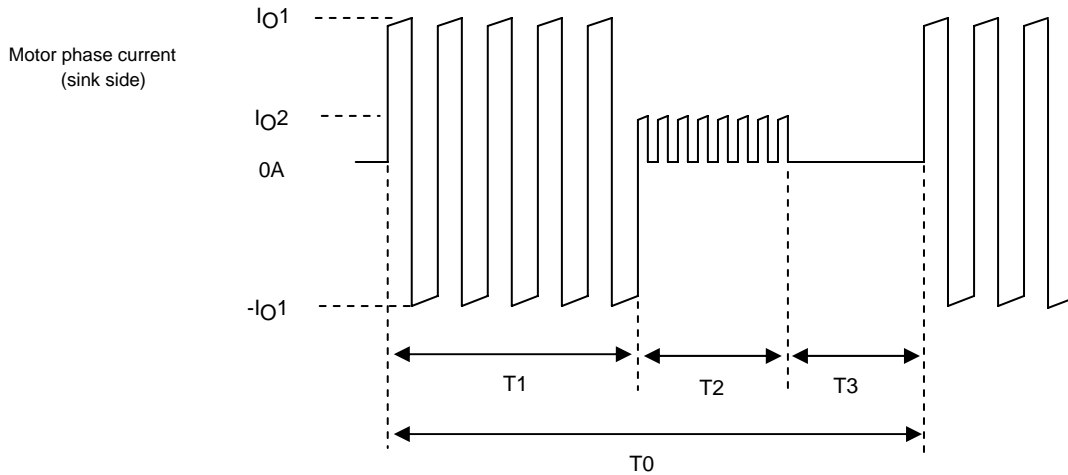

Figure 1 Motor Current Timing

T1: Motor rotation operation time

T2: Motor hold operation time

T3: Motor current off time

T2 may be reduced, depending on the application.

T0: Single repeated motor operating cycle

IO1 and IO2: Motor current peak values

Due to the structure of motor windings, the phase current is a positive and negative current with a pulse form.

Note that figure 1 presents the concepts here, and that the on/off duty of the actual signals will differ.

The hybrid IC internal average power dissipation PdAV can be calculated from the following formula.

$$PdAV = (T1 \times P1 + T2 \times P2 + T3 \times 0) \div T0 \text{ ----- (I)}$$

(Here, P1 is the PDAV for IO1 and P2 is the PDAV for IO2)

If the value calculated using Equation (I) is 1.5W or less, and the ambient temperature, Ta, is 60°C or less, there is no need to attach a heat sink. Refer to Figure 2 for operating substrate temperature data when no heat sink is used.

[Operating range in which a heat sink is used]

Although a heat sink is attached to lower Tc if PdAV increases, the resulting size can be found using the value of θc-a in Equation (II) below and the graph depicted in Figure 3.

$$\theta_{c-a} = (T_c \text{ max} - T_a) \div PdAV \text{ ----- (II)}$$

Tc max: Maximum operating substrate temperature = 105°C

Ta: HIC ambient temperature

Although a heat sink can be designed based on equations (I) and (II) above, be sure to mount the HIC in a set and confirm that the substrate temperature, Tc, is 105°C or less.

The average HIC power loss, PdAV, described above represents the power loss when there is no avalanche operation. To add the loss during avalanche operations, be sure to add Equation (2), “Allowable STK672-6** Avalanche Energy Value”, to PdAV.

Figure 2 Substrate temperature rise, ΔT_c (no heat sink) - Internal average power dissipation, PdAV

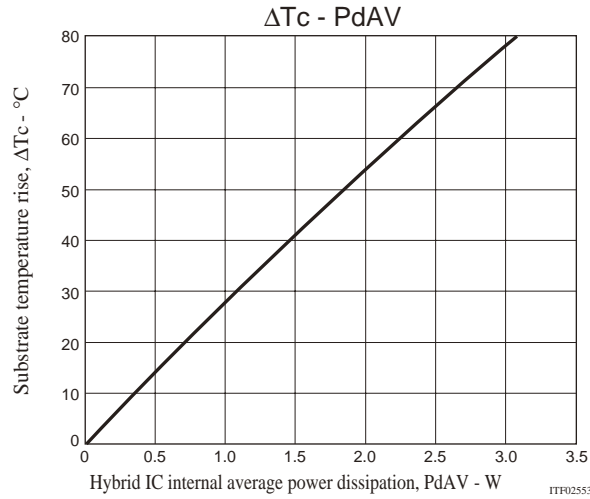
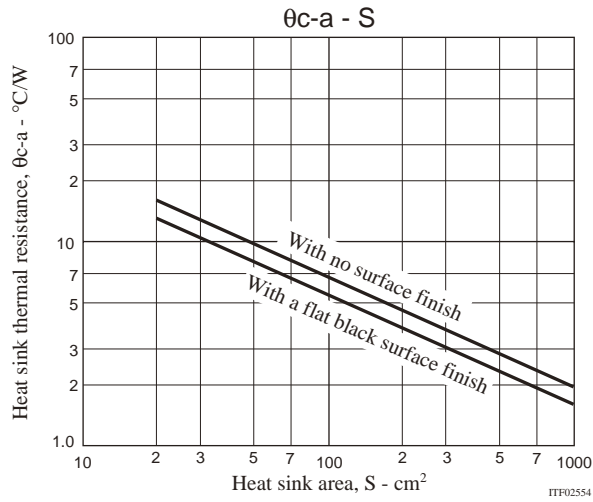

Figure 3 Heat sink area (Board thickness: 2mm) - θ_{c-a}



5. Mitigated Curve of Package Power Loss, PdPK, vs. Ambient Temperature, Ta

Package power loss, PdPK, refers to the average internal power loss, PdAV, allowable without a heat sink. The figure below represents the allowable power loss, PdPK, vs. fluctuations in the ambient temperature, Ta. Power loss of up to 3.1W is allowable at Ta=25°C, and of up to 1.75W at Ta=60°C.

Allowable power dissipation, PdPK(no heat sink) - Ambient temperature, Ta

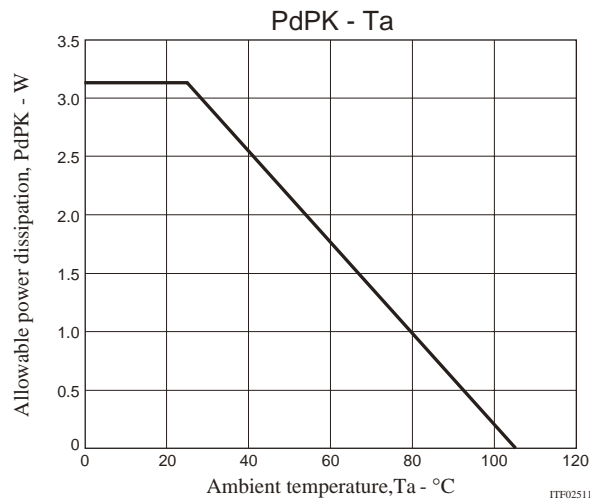

6. Example of Stepping Motor Driver Output Current Path (1-2 phase excitation)

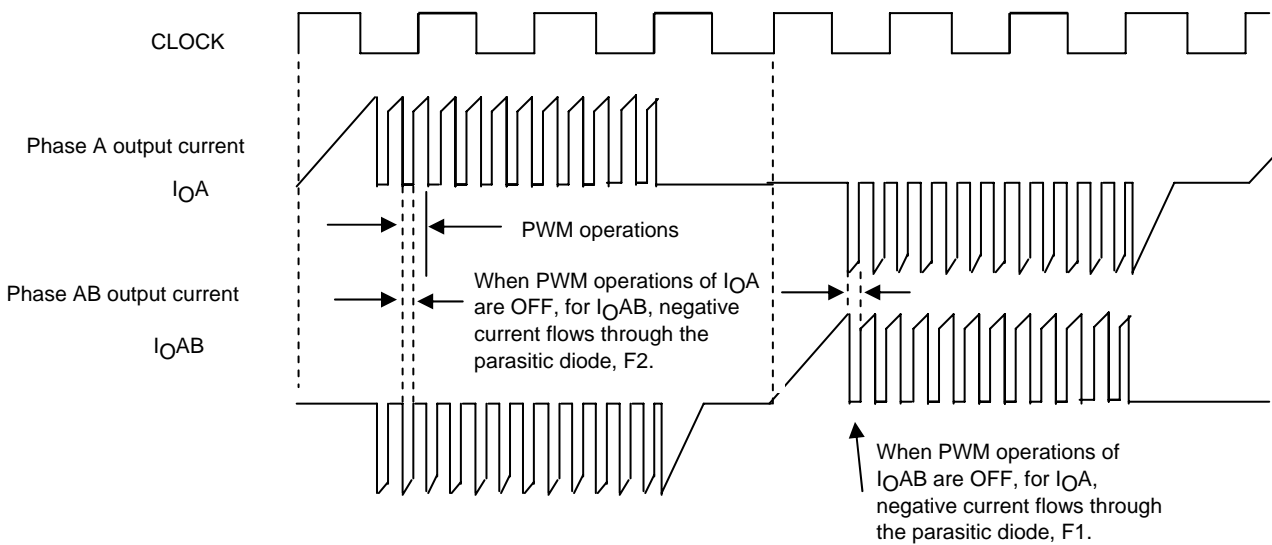
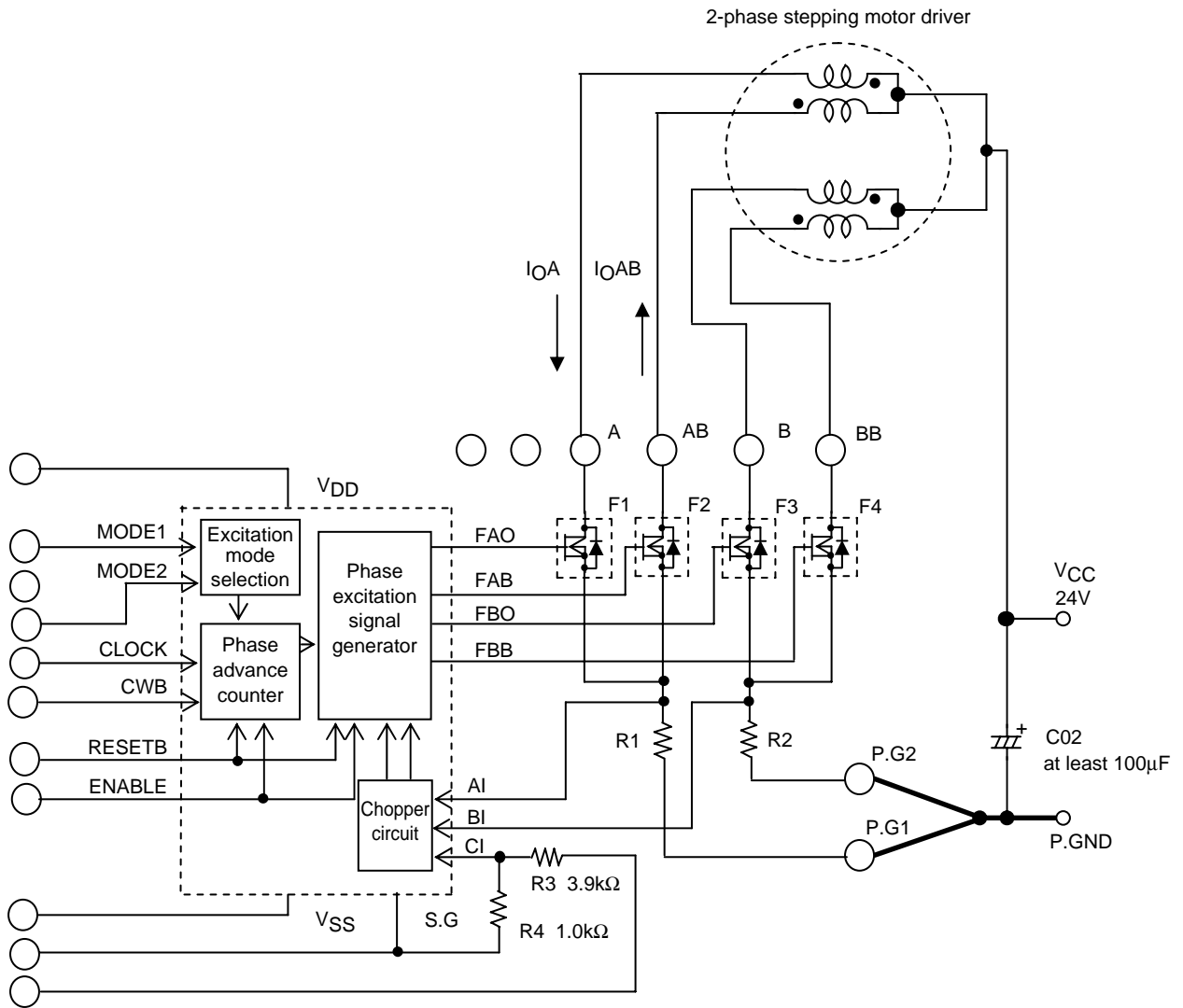

ON Semiconductor and the ON logo are registered trademarks of Semiconductor Components Industries, LLC (SCILLC). SCILLC owns the rights to a number of patents, trademarks, copyrights, trade secrets, and other intellectual property. A listing of SCILLC's product/patent coverage may be accessed at www.onsemi.com/site/pdf/Patent-Marking.pdf. SCILLC reserves the right to make changes without further notice to any products herein. SCILLC makes no warranty, representation or guarantee regarding the suitability of its products for any particular purpose, nor does SCILLC assume any liability arising out of the application or use of any product or circuit, and specifically disclaims any and all liability, including without limitation special, consequential or incidental damages. "Typical" parameters which may be provided in SCILLC data sheets and/or specifications can and do vary in different applications and actual performance may vary over time. All operating parameters, including "Typicals" must be validated for each customer application by customer's technical experts. SCILLC does not convey any license under its patent rights nor the rights of others. SCILLC products are not designed, intended, or authorized for use as components in systems intended for surgical implant into the body, or other applications intended to support or sustain life, or for any other application in which the failure of the SCILLC product could create a situation where personal injury or death may occur. Should Buyer purchase or use SCILLC products for any such unintended or unauthorized application, Buyer shall indemnify and hold SCILLC and its officers, employees, subsidiaries, affiliates, and distributors harmless against all claims, costs, damages, and expenses, and reasonable attorney fees arising out of, directly or indirectly, any claim of personal injury or death associated with such unintended or unauthorized use, even if such claim alleges that SCILLC was negligent regarding the design or manufacture of the part. SCILLC is an Equal Opportunity/Affirmative Action Employer. This literature is subject to all applicable copyright laws and is not for resale in any manner.

X-ON Electronics

Largest Supplier of Electrical and Electronic Components

Click to view similar products for [Motor/Motion/Ignition Controllers & Drivers](#) category:

Click to view products by [ON Semiconductor](#) manufacturer:

Other Similar products are found below :

[FSB50550TB2](#) [FSBF15CH60BTH](#) [MSVCPM2-63-12](#) [MSVGW45-14-2](#) [MSVGW54-14-3](#) [MSVGW54-14-5](#) [NTE7043](#) [LA6565VR-TLM-E](#)
[LB11650-E](#) [LB1837M-TLM-E](#) [LB1845DAZ-XE](#) [LC898300XA-MH](#) [SS30-TE-L-E](#) [26700](#) [LV8281VR-TLM-H](#) [BA5839FP-E2](#) [IRAM236-1067A](#) [LA6584JA-AH](#) [LB11847L-E](#) [NCV70501DW002R2G](#) [AH293-PL-B](#) [STK672-630CN-E](#) [TND315S-TL-2H](#) [FNA23060](#) [FSB50250AB](#)
[FNA41060](#) [MSVB54](#) [MSVBTC50E](#) [MSVCPM3-54-12](#) [MSVCPM3-63-12](#) [MSVCPM4-63-12](#) [MSVTA120](#) [FSB50550AB](#)
[NCV70501DW002G](#) [LC898301XA-MH](#) [LV8413GP-TE-L-E](#) [MSVGW45-14-3](#) [MSVGW45-14-4](#) [MSVGW45-14-5](#) [MSVGW54-14-4](#)
[STK984-091A-E](#) [MP6519GQ-Z](#) [LB11651-E](#) [IRSM515-025DA4](#) [LV8127T-TLM-H](#) [MC33812EKR2](#) [NCP81382MNTXG](#) [TDA21801](#)
[LB11851FA-BH](#) [NCV70627DQ001R2G](#)