



SANYO Semiconductors

**DATA SHEET****TND507S**

ExPD (Excellent Power Device)

**Ballast, General Purpose Driver for Applications Including PDP Sustain Pulse Drive, DC / AC Motor Drive, Induction Heating, Battery Charger, High Frequency Switching Power Supply, and Switching Amplifiers**

**Features**

- Monolithic structure.
- Single input and two output.
- Allows simplified configuration of driver circuit.
- Withstand voltage of 600V is assured.
- Built-in shutdown protection function.

**Specifications****Absolute Maximum Ratings** at Ta=25°C (All voltage parameters are absolute voltage referenced to GND)

Parameter	Symbol	Conditions	Ratings	Unit
High Side Floating Supply Absolute Voltage	V <sub>H</sub>		-0.3 to 625	V
High Side Floating Supply Offset Voltage	V <sub>HFG</sub>		V <sub>H</sub> -25 to V <sub>H</sub> +0.3	V
High Side Output Voltage	V <sub>HOUT</sub>		V <sub>HFG</sub> -0.3 to V <sub>H</sub> +0.3	V
Low Side Fixed Supply Voltage	V <sub>L</sub>		-0.3 to 25	V
Low Side Output Voltage	V <sub>LOUT</sub>		-0.3 to V <sub>L</sub> +0.3	V
Logic Input Voltage	V <sub>IN</sub>		-0.3 to V <sub>L</sub> +0.3	V
Allowable Power Dissipation	P <sub>D</sub>		0.3	W
Junction Temperature	T <sub>J</sub>		-55 to +150	°C
Storage Temperature	T <sub>stg</sub>		-55 to +150	°C

■ Any and all SANYO Semiconductor products described or contained herein do not have specifications that can handle applications that require extremely high levels of reliability, such as life-support systems, aircraft's control systems, or other applications whose failure can be reasonably expected to result in serious physical and/or material damage. Consult with your SANYO Semiconductor representative nearest you before using any SANYO Semiconductor products described or contained herein in such applications.

■ SANYO Semiconductor assumes no responsibility for equipment failures that result from using products at values that exceed, even momentarily, rated values (such as maximum ratings, operating condition ranges, or other parameters) listed in products specifications of any and all SANYO Semiconductor products described or contained herein.

**SANYO Semiconductor Co., Ltd.**

TOKYO OFFICE Tokyo Bldg., 1-10, 1 Chome, Ueno, Taito-ku, TOKYO, 110-8534 JAPAN

**Recommended Operating Conditions** at  $T_a=25^\circ\text{C}$ 

Parameter	Symbol	Conditions	Ratings	Unit
High Side Floating Supply Absolute Voltage	$V_H$		$V_{HFG}+10$ to $V_{HFG}+20$	V
High Side Floating Supply Offset Voltage	$V_{HFG}$		0 to 600	V
High Side Output Voltage	$V_{HOUT}$		$V_{HFG}$ to $V_H$	V
Low Side Fixed Supply Voltage	$V_L$		10 to 20	V
Low Side Output Voltage	$V_{LOUT}$		0 to $V_L$	V
Logic Input Voltage	$V_{IN}$		0 to $V_L$	V
Ambient Temperature	$T_a$		-40 to +125	$^\circ\text{C}$

**AC Characteristics** at  $T_a=25^\circ\text{C}$  ( $V_L=V_{HHFG}=15\text{V}$ ,  $C_L=1000\text{pF}$ )

Parameter	Symbol	Conditions	Ratings			Unit
			min	typ	max	
Turn-ON Delay Time	$t_{on}$	$V_{HFG}=0$		950		ns
Turn-OFF Delay Time	$t_{off}$	$V_{HFG}=600\text{V}$		150		ns
Turn-ON Rise Time	$t_r$	$C_L=1000\text{pF}$		120		ns
Turn-OFF Fall Time	$t_f$	$C_L=1000\text{pF}$		60		ns
Delay Matching	MT	$ Ht_{on}-L_{ton} ,  Ht_{off}-L_{toff} $		30		ns
Dead Time	DT			800		ns

**DC Characteristics** at  $T_a=25^\circ\text{C}$  ( $V_L=V_{HHFG}=15\text{V}$ )

Parameter	Symbol	Conditions	Ratings			Unit
			min	typ	max	
Logic "1" Input Voltage	$V_{IH}$	$V_L=10\text{V}$	6.4			V
		$V_L=15\text{V}$	9.5			V
		$V_L=20\text{V}$	12.8			V
Logic "0" Input Voltage	$V_{IL}$	$V_L=10\text{V}$			3.7	V
		$V_L=15\text{V}$			5.8	V
		$V_L=20\text{V}$			7.7	V
High-level Output Voltage( $V_{BIAS}-V_O$ )	$V_{OH}$	$I_O=0$			100	mV
Low-level Output Voltage( $V_O$ )	$V_{OL}$	$I_O=0$			100	mV
Offset Supply Leakage Current	$I_{LK}$	$V_H=V_{HFG}=600\text{V}$			10	$\mu\text{A}$
Quiescent $V_H$ Supply Current	$I_{QH}$	$V_{IN}=0$ or $V_L$		50	100	$\mu\text{A}$
Quiescent $V_L$ Supply Current	$I_{QL}$	$V_{IN}=0$ or $V_L$		70	180	$\mu\text{A}$
Logic "1" Input Bias Current	$I_{IN+}$	$V_{IN}=15\text{V}$		20	40	$\mu\text{A}$
Logic "0" Input Bias Current	$I_{IN-}$	$V_{IN}=0$			1	$\mu\text{A}$
$V_H$ Supply Undervoltage Positive Going Threshold	$V_{HUV+}$		7.6	8.9	9.9	V
$V_H$ Supply Undervoltage Negative Going Threshold	$V_{HUV-}$		6.7	8.1	9.5	V
$V_L$ Supply Undervoltage Positive Going Threshold	$V_{LUV+}$		7.6	8.9	9.9	V
$V_L$ Supply Undervoltage Negative Going Threshold	$V_{LUV-}$		6.7	8.1	9.5	V
Output High Short Circuit Pulsed Current	$I_{O+}$	$V_{OUT}=0, PW\leq 10\mu\text{s}$	200	250		mA
Output Low Short Circuit Pulsed Current	$I_{O-}$	$V_{OUT}=15\text{V}, PW\leq 10\mu\text{s}$	420	500		mA

**Package Dimensions**

unit : mm (typ)  
7005-010

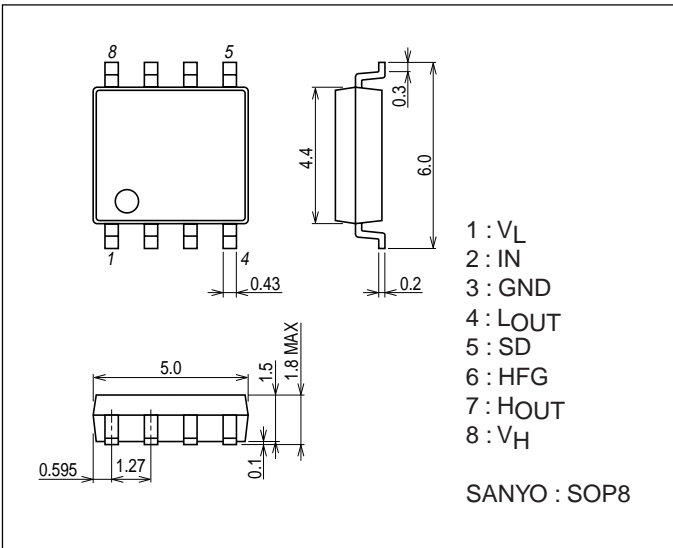

**Block Diagram**

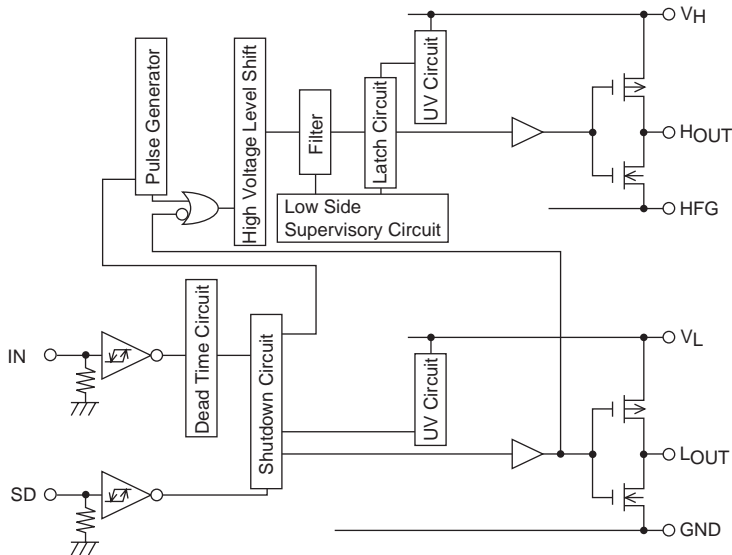

**Switching Time Test Circuit**

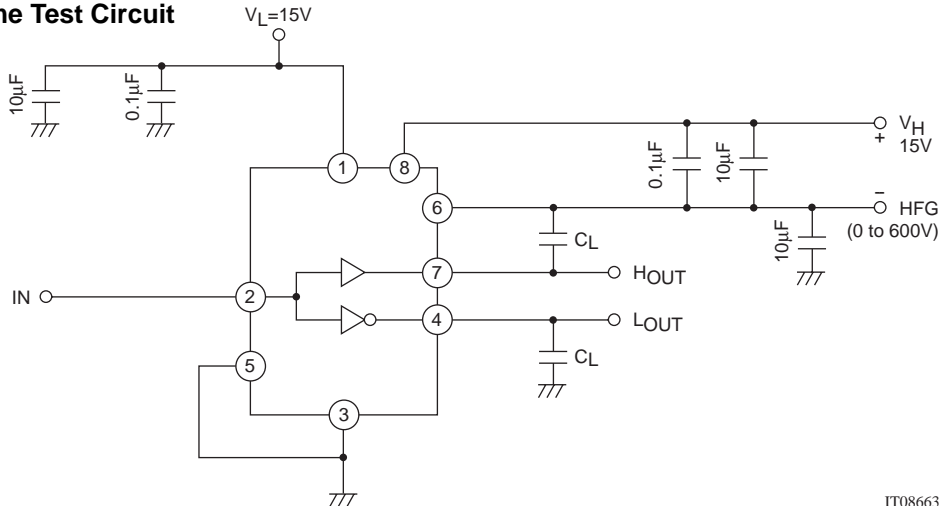

IT08663

**Switching Time Waveform Definition**

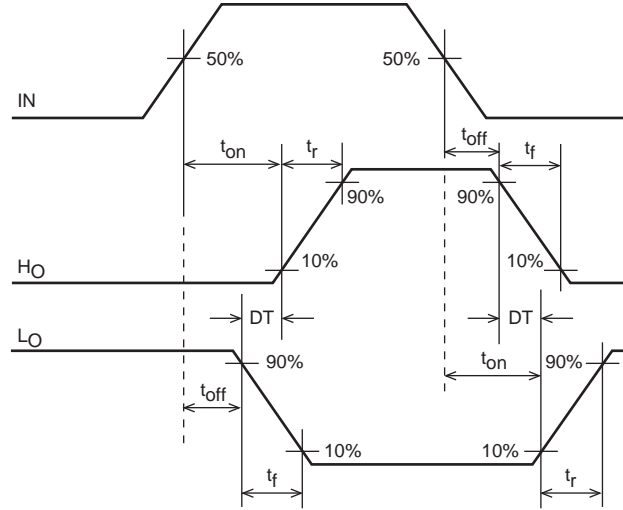

IT08664

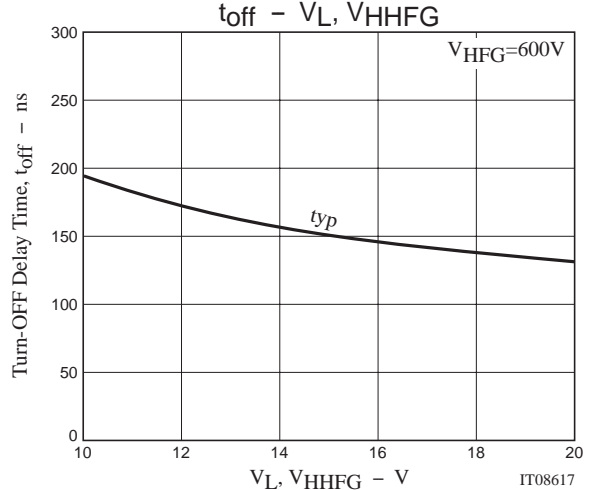
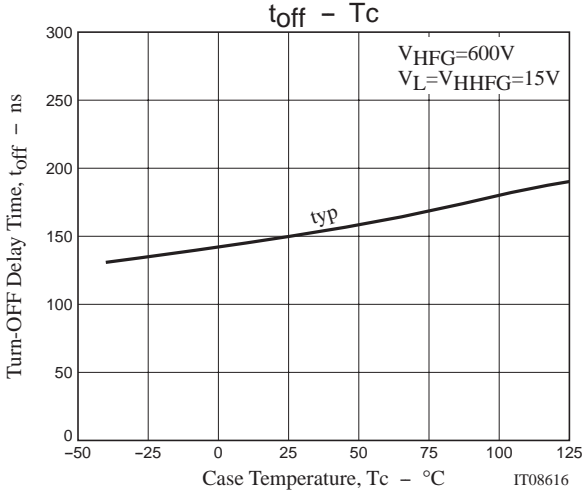
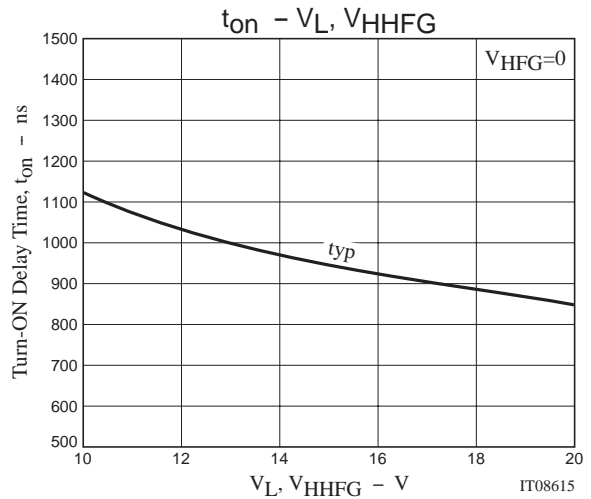
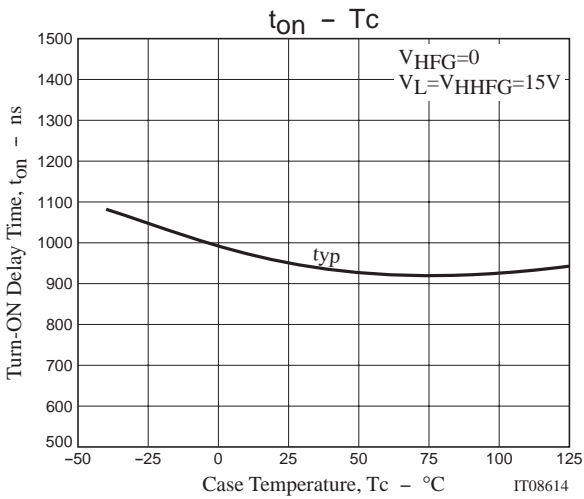

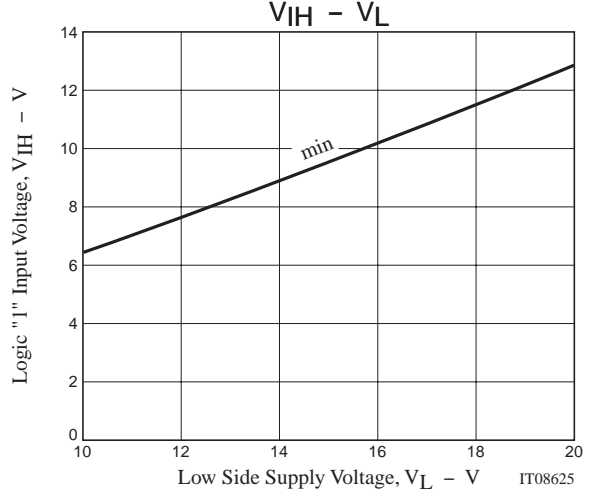
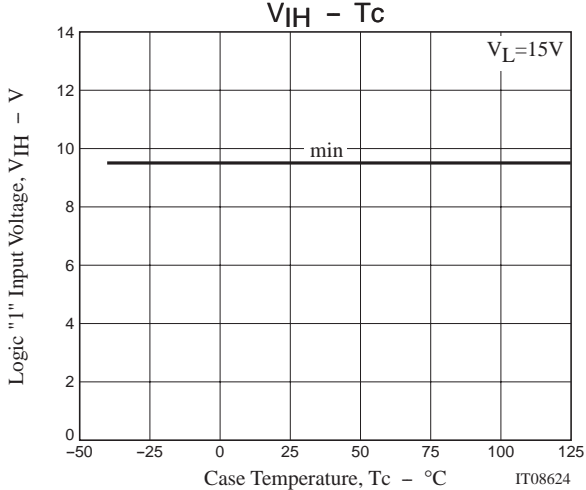
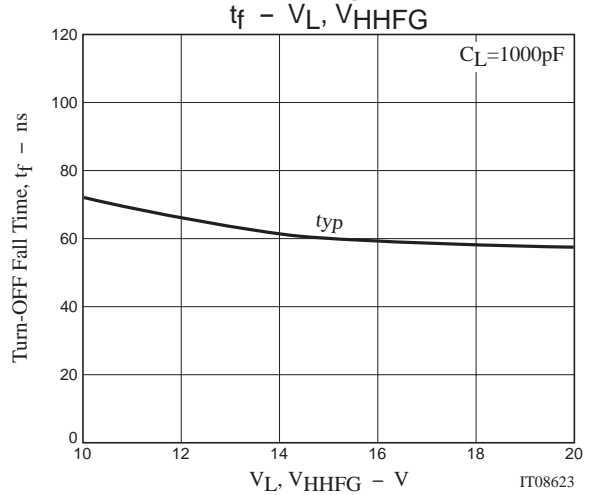
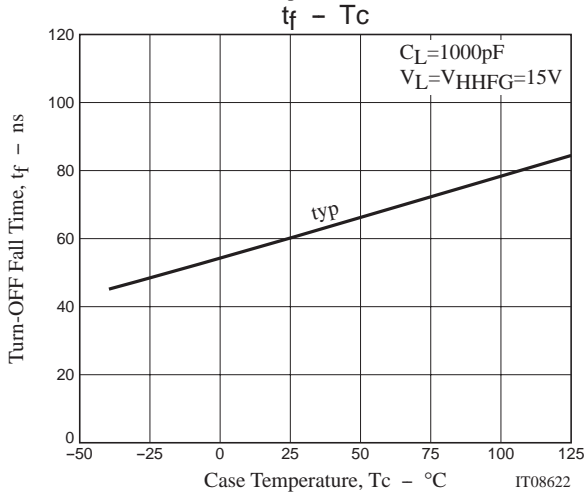
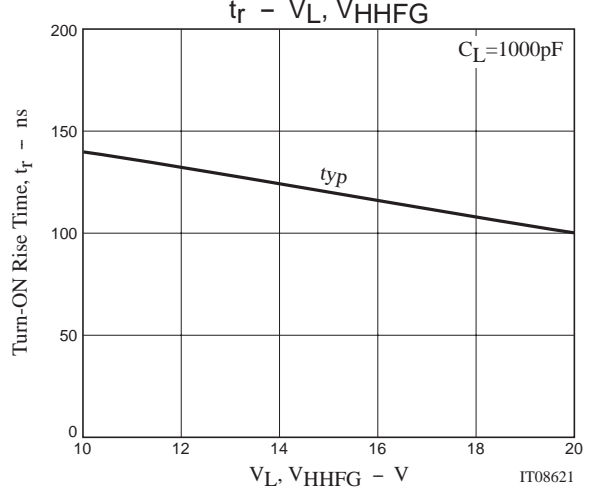
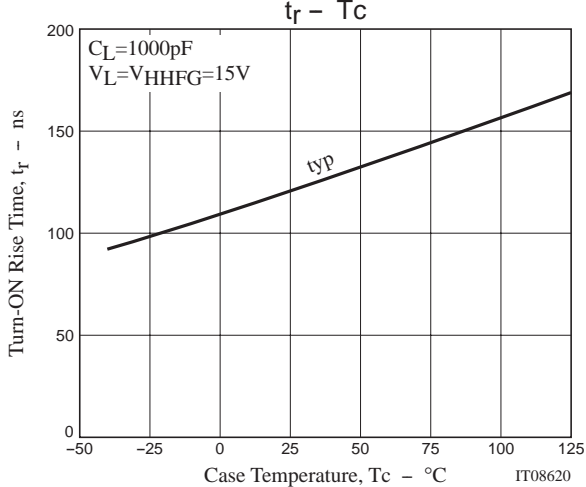
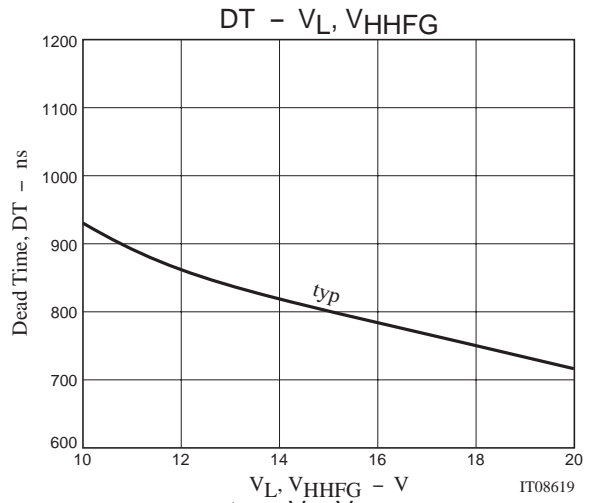
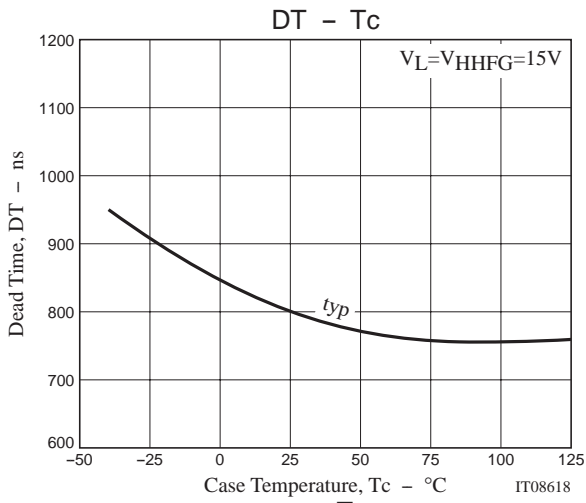

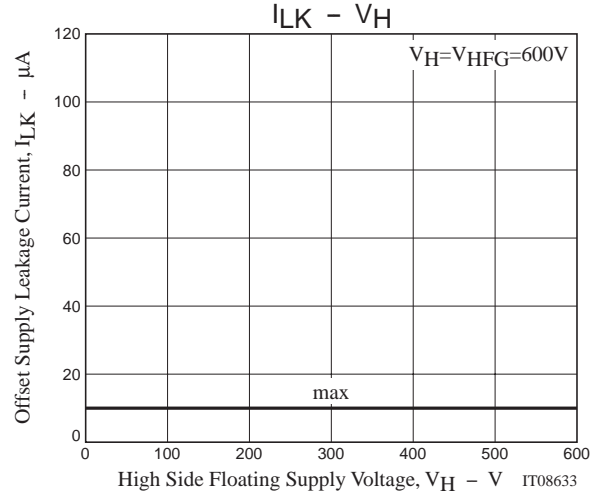
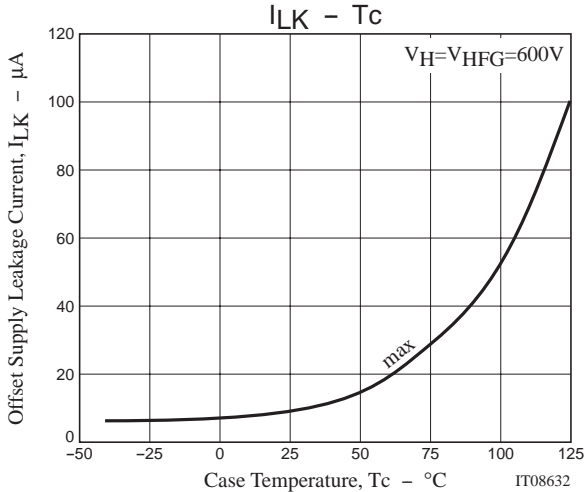
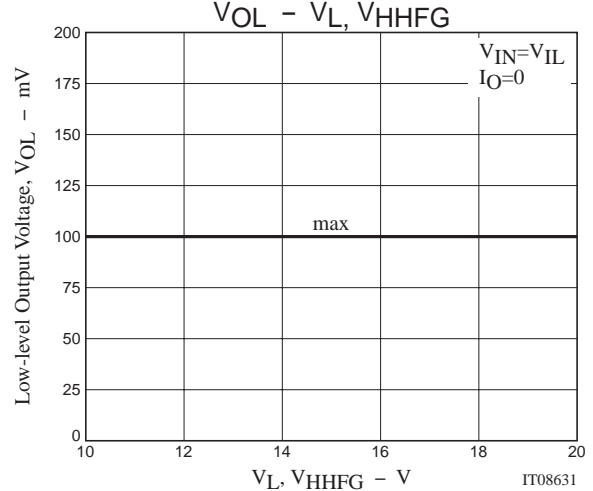
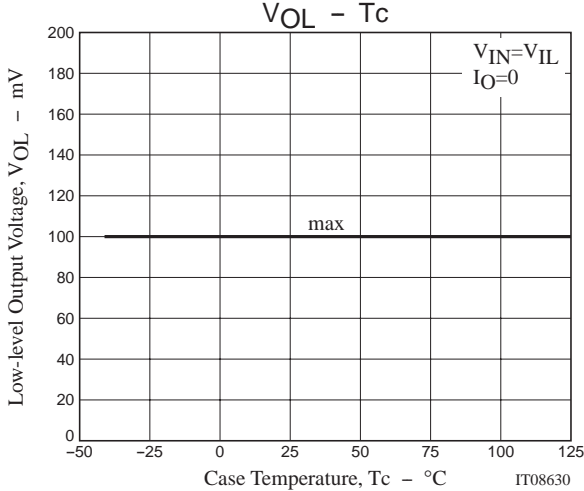
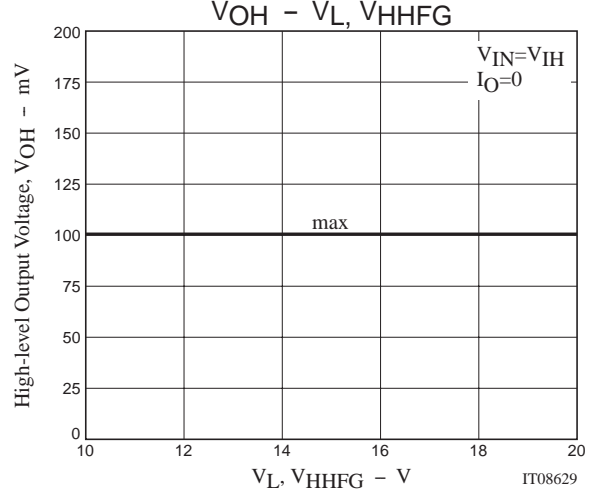
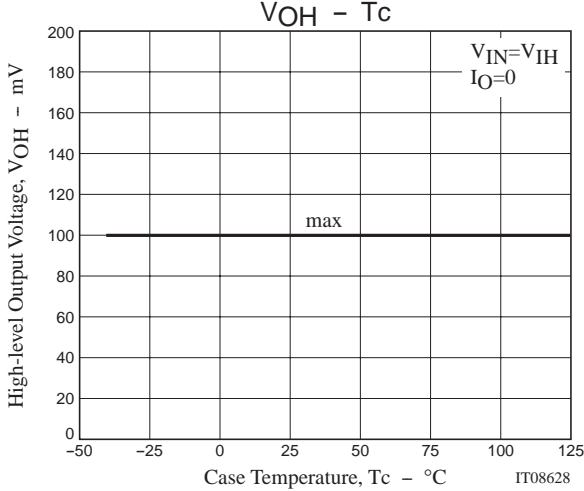
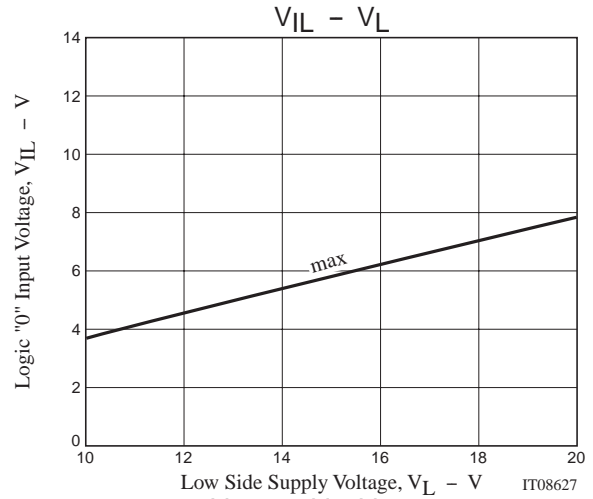
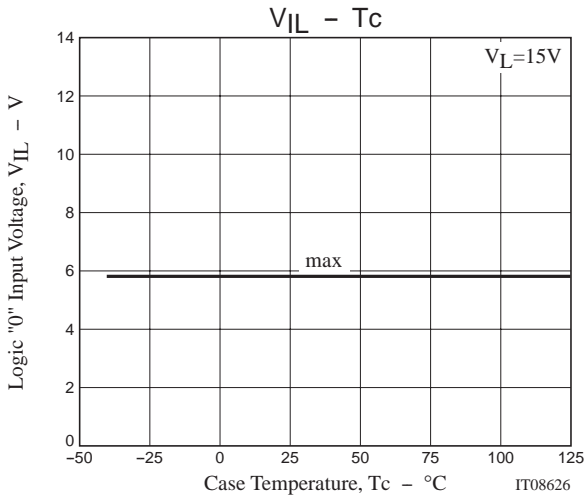

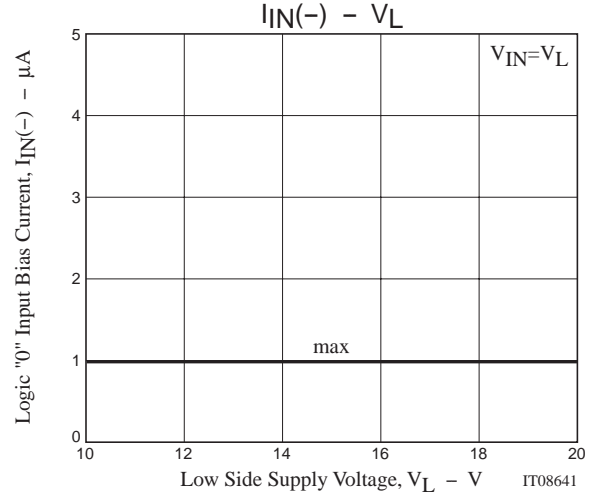
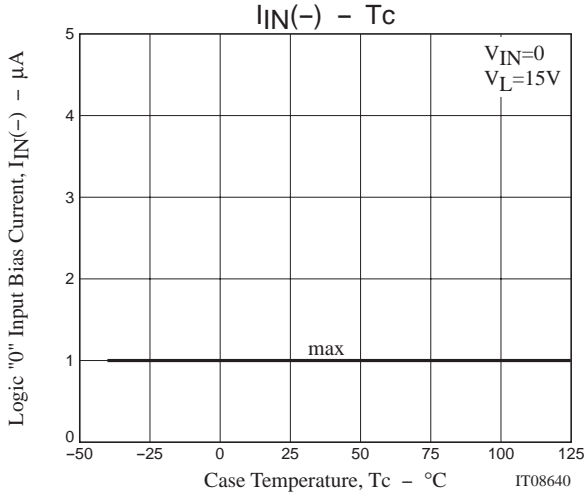
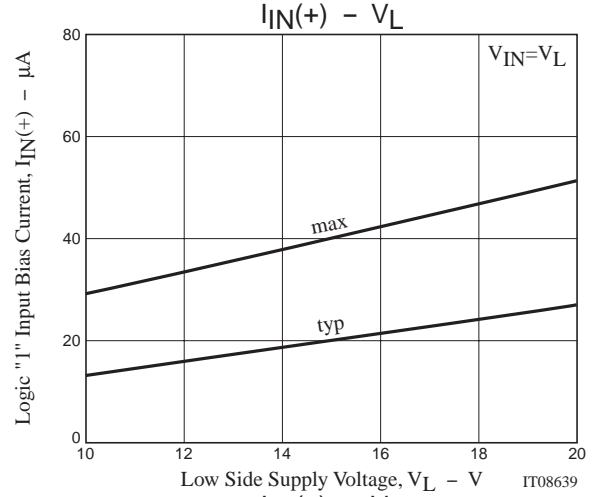
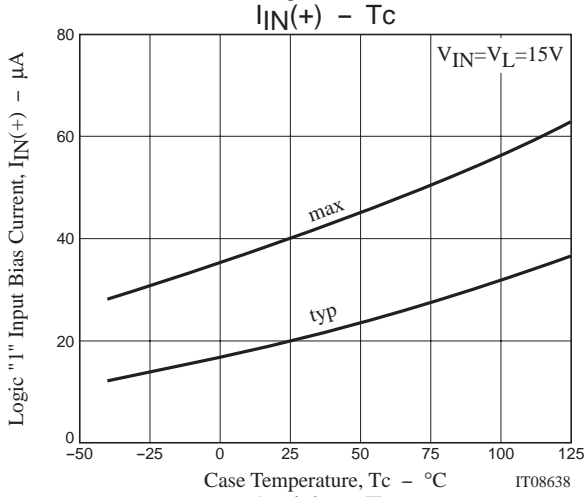
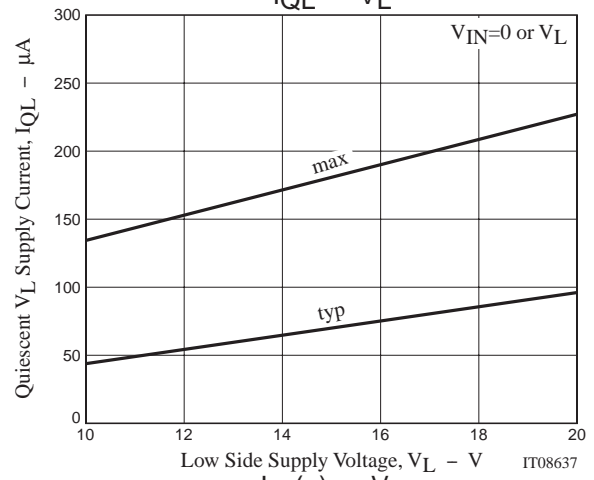
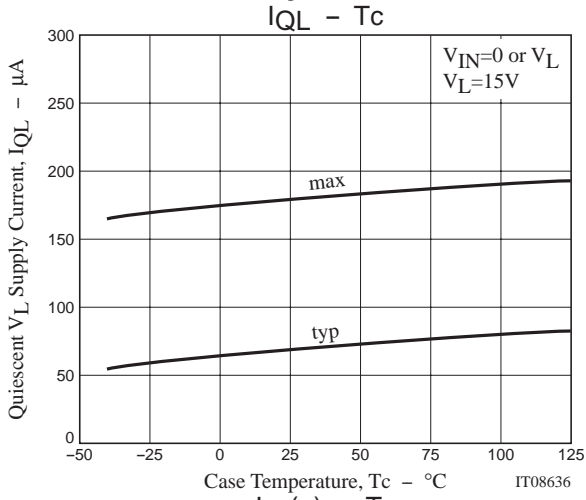
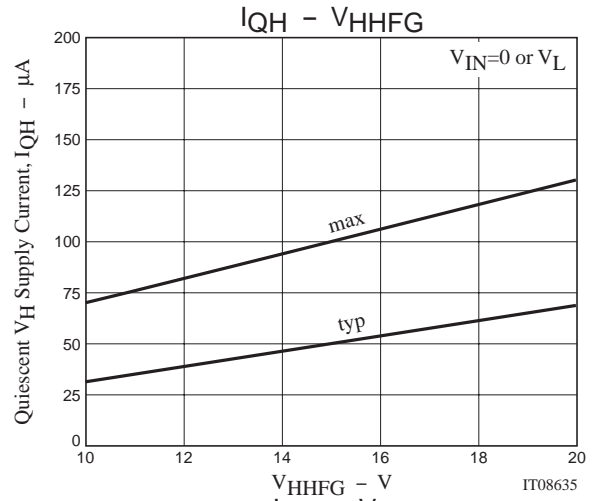
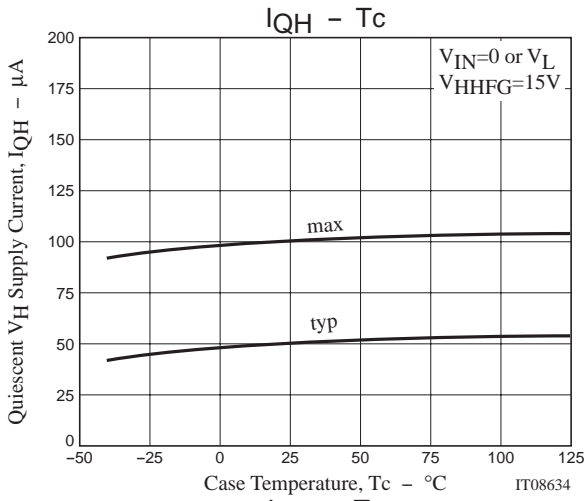

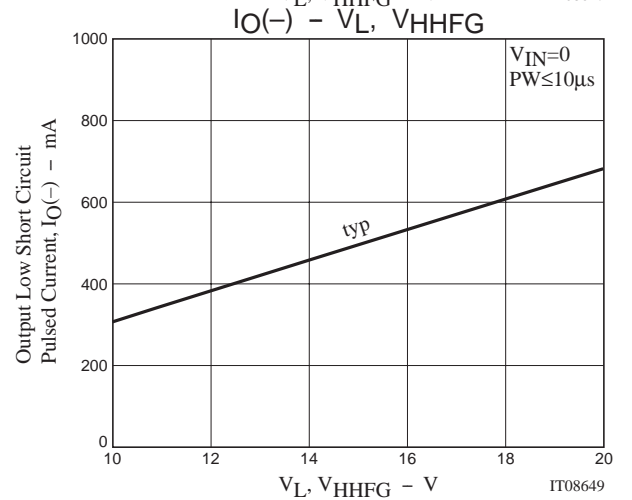
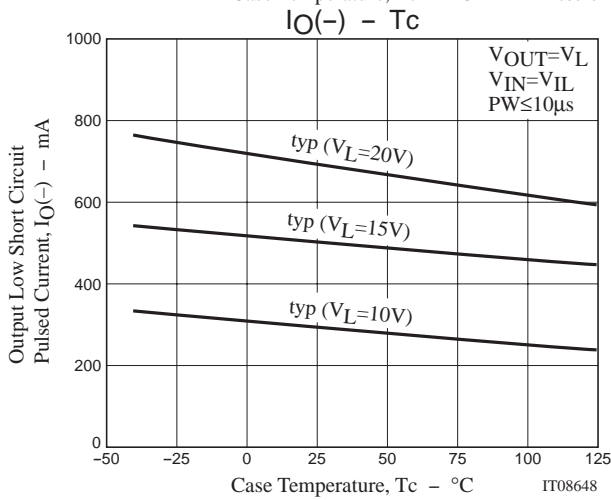
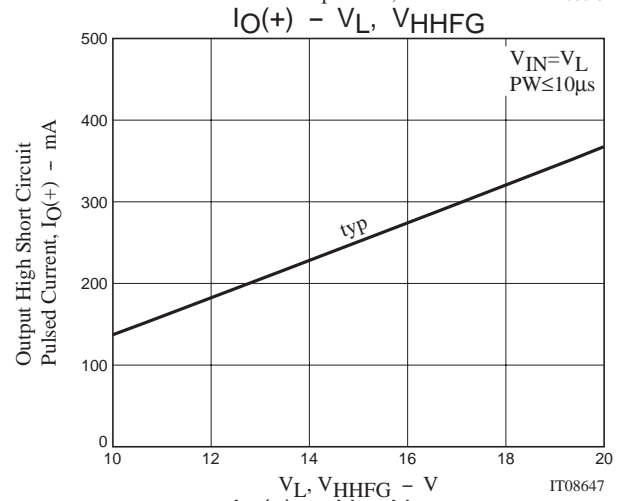
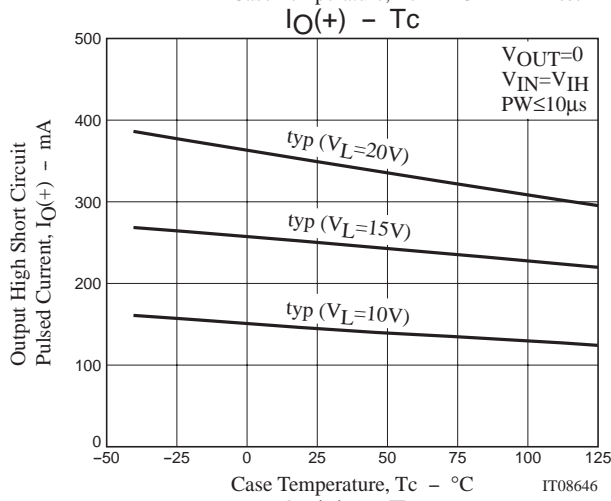
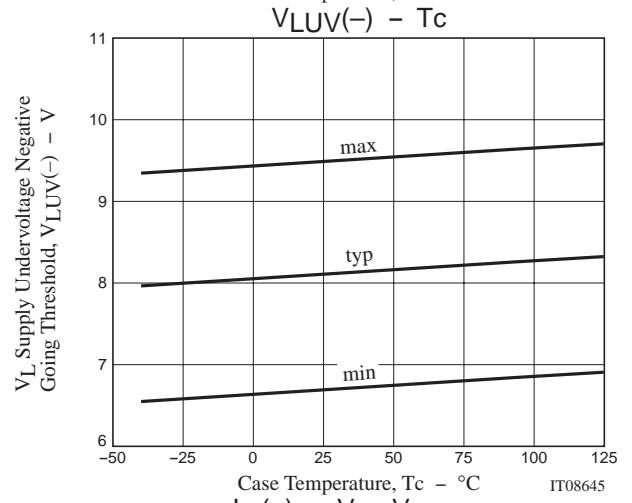
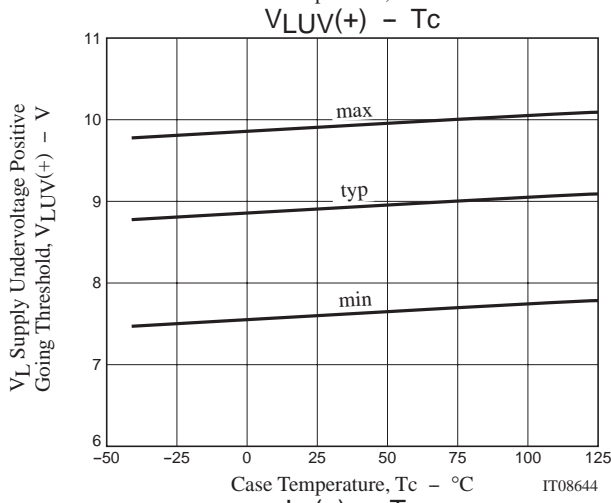
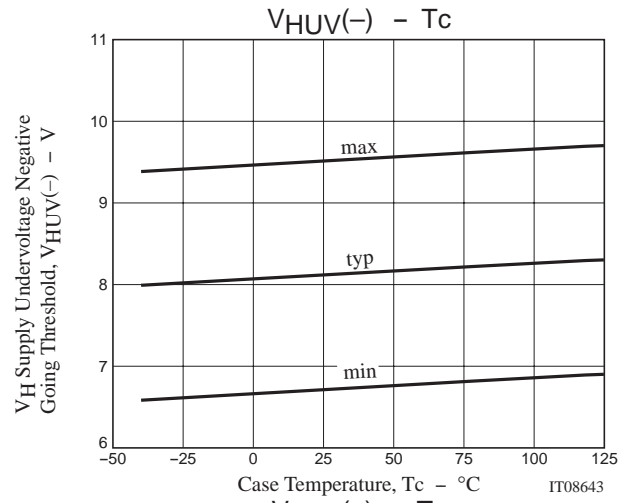
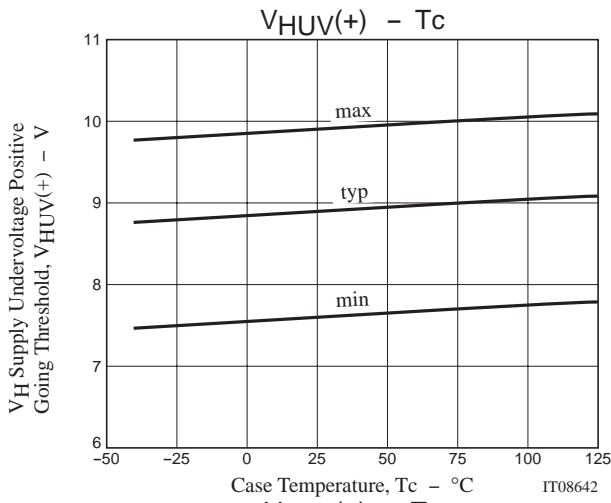



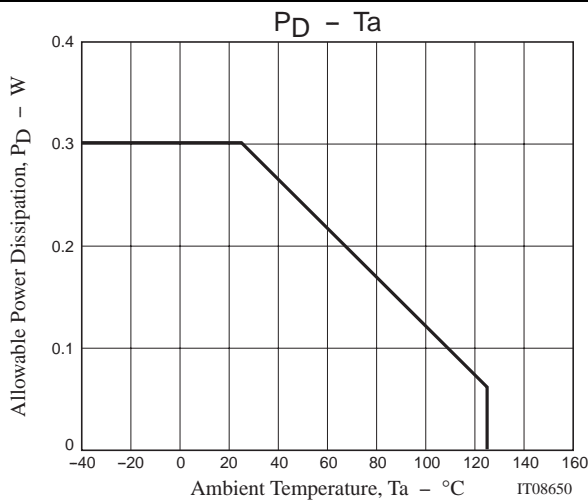

- Specifications of any and all SANYO Semiconductor products described or contained herein stipulate the performance, characteristics, and functions of the described products in the independent state, and are not guarantees of the performance, characteristics, and functions of the described products as mounted in the customer's products or equipment. To verify symptoms and states that cannot be evaluated in an independent device, the customer should always evaluate and test devices mounted in the customer's products or equipment.
- SANYO Semiconductor Co., Ltd. strives to supply high-quality high-reliability products. However, any and all semiconductor products fail with some probability. It is possible that these probabilistic failures could give rise to accidents or events that could endanger human lives, that could give rise to smoke or fire, or that could cause damage to other property. When designing equipment, adopt safety measures so that these kinds of accidents or events cannot occur. Such measures include but are not limited to protective circuits and error prevention circuits for safe design, redundant design, and structural design.
- In the event that any or all SANYO Semiconductor products (including technical data, services) described or contained herein are controlled under any of applicable local export control laws and regulations, such products must not be exported without obtaining the export license from the authorities concerned in accordance with the above law.
- No part of this publication may be reproduced or transmitted in any form or by any means, electronic or mechanical, including photocopying and recording, or any information storage or retrieval system, or otherwise, without the prior written permission of SANYO Semiconductor Co., Ltd.
- Any and all information described or contained herein are subject to change without notice due to product/technology improvement, etc. When designing equipment, refer to the "Delivery Specification" for the SANYO Semiconductor product that you intend to use.
- Information (including circuit diagrams and circuit parameters) herein is for example only; it is not guaranteed for volume production. SANYO Semiconductor believes information herein is accurate and reliable, but no guarantees are made or implied regarding its use or any infringements of intellectual property rights or other rights of third parties.

This catalog provides information as of September, 2006. Specifications and information herein are subject to change without notice.

## X-ON Electronics

Largest Supplier of Electrical and Electronic Components

*Click to view similar products for [Gate Drivers](#) category:*

*Click to view products by [ON Semiconductor](#) manufacturer:*

Other Similar products are found below :

[00028](#) [00053P0231](#) [8967380000](#) [56956](#) [CR7E-30DB-3.96E\(72\)](#) [57.404.7355.5](#) [LT4936](#) [57.904.0755.0](#) [5801-0903](#) [5803-0901](#) [5811-0902](#)  
[5813-0901](#) [58410](#) [00576P0030](#) [00581P0070](#) [5882900001](#) [00103P0020](#) [00600P0005](#) [00-9050-LRPP](#) [00-9090-RDPP](#) [5951900000](#) [01-](#)  
[1003W-10/32-15](#) [LTI LA6E-1S-WH-RC-FN12VXCR1](#) [0131700000](#) [00-2240](#) [LTP70N06](#) [LVP640](#) [0158-624-00](#) [5J0-1000LG-SIL](#) [020017-13](#)  
[LY1D-2-5S-AC120](#) [LY2-0-US-AC120](#) [LY2-US-AC240](#) [LY3-UA-DC24](#) [00-5150](#) [00576P0020](#) [00600P0010](#) [LZNQ2M-US-DC5](#) [LZNQ2-](#)  
[US-DC12](#) [LZP40N10](#) [00-8196-RDPP](#) [00-8274-RDPP](#) [00-8275-RDNP](#) [00-8609-RDPP](#) [00-8722-RDPP](#) [00-8728-WHPP](#) [00-8869-RDPP](#) [00-](#)  
[9051-RDPP](#) [00-9091-LRPP](#) [00-9291-RDPP](#)