

◆ **Features:**

- common anode control for RGB LED strips
- low power consumption
- 24 months warranty
- suitable for power supplies
- suitable for RGB amplifiers
- PWM output
- Easy connection
- Touch panel remote controller

◆ **Photo:**

CE

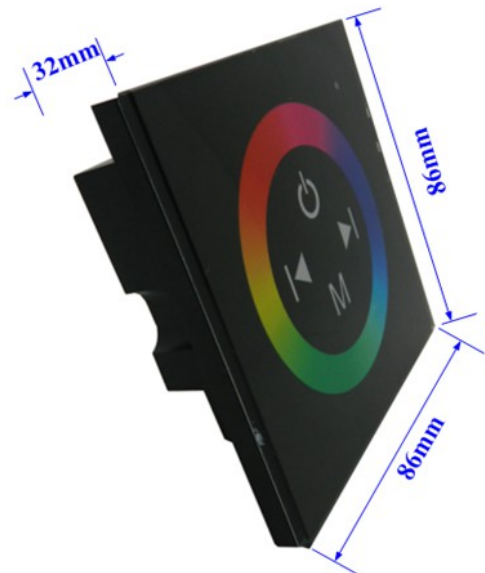

Input	Working voltage	12Vdc +/- 5% 24Vdc +/- 5%
	Static power consumption	1W
	Supply connector	Plug 2,1x5,5mm or screw terminal
Output	Output type	PWM
	Output voltage*	0-12V 0-24V
	Channel quantity	3 (R,G,B)
	Single channel max. current	4A
	Full channel max current	12A
	Max single output power	48W (for 12Vdc) 96W (for 24Vdc)
	Max full channel output power	144W (for 12Vdc) 288W (for 24Vdc)
	Type control	Common anode**
Control	Match code	Yes
	Static mode	Yes
	Dynamic mode	Yes
Other	Working temp.	-20...+40°C
	Weight netto	172g
	Weight brutto	392g
	Controller dimension L x W x H	86 x 86 x 36 mm
	Package dimension L x W x H	100 x 100 x 60 mm
	Warranty	24m

* depends on working voltage

** with common "+"

*** match code helps do not interference two controllers working in the same area

◆ OUTPUT DIMMENSION

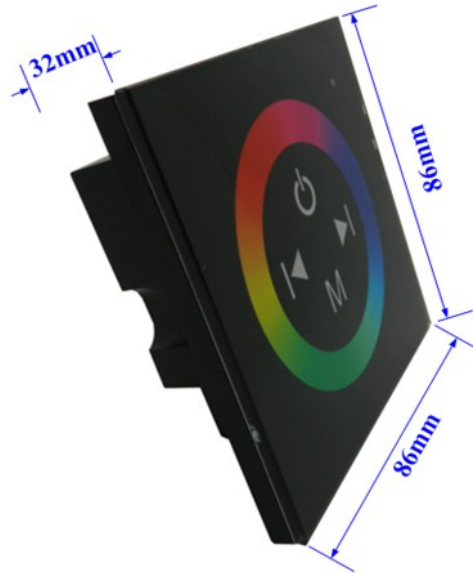

◆ TYPICAL APPLICATION

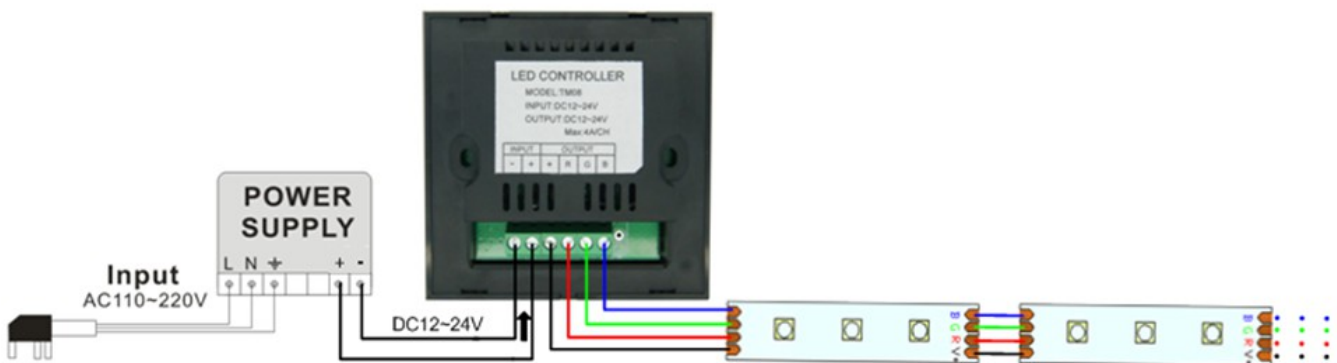

◆ CONNECTOR DESCRIPTION



◆ DYNAMIC MODE FUNCTION LIST

nr	function	nr	function	nr	function
1	Static red	7	Static white	13	Seven color flow
2	Static green	8	Three color jump	14	Three-colors flash frequency
3	Static blue	9	Seven color jump	15	Seven-colors flash frequency
4	Static yellow	10	Three Color fade	16	Three-colors blasting flash
5	Static purple	11	Three color flow	17	Seven color blasting flash
6	Static cyan	12	seven Color fade	18	Automatic mode





* white colour is not pure white, can be hue of other colours

◆ **PANEL FUNCTION DESCRIPTION**

PANEL STATIC AND DYNAMIC FUNCTIONS:

nr	funkction	nr	funkction
1	Static red	7	Static white
2	Static green	8	Three color jump
3	Static blue	9	Three color gradual
4	Static yellow	10	Seven color jump
5	Static purple	11	Seven color gradual
6	Static cyan	12	-----

OPIS PANELU DOTYKOWEGO

	opis
	Touch this key to turn ON/OFF the controller on any state;
	Mode key, could change one of 11 static/dynamic programs
	Touch this key can increasing the output single brightness or speed,touch each time , the brightness or speed will increase 1 level(total 16 level)
	Touch this key can reducing the output signal brightness or speed.touch each time will reduce 1 level
	Multicolor pulley touch key, static color mode selection key, up to 64 touch points

◆ **INSTALATION WITH 86x86MM BOX**

1

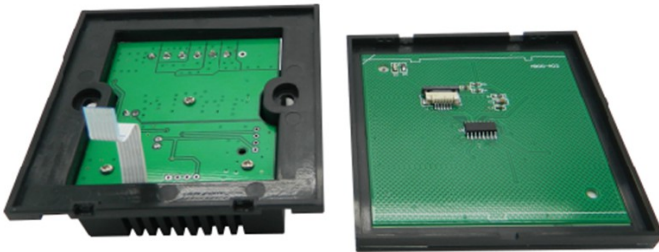

2



3



4



X-ON Electronics

Largest Supplier of Electrical and Electronic Components

Click to view similar products for [LED Displays & Accessories](#) category:

Click to view products by [Optoflash](#) manufacturer:

Other Similar products are found below :

[LTC-2721WC](#) [LTC-4624JD](#) [LTC-4627G](#) [LTC-4627WC](#) [LTD-5021AWC](#) [LTM-8522G](#) [LTP-4323P](#) [LTP-747G](#) [LTS-3361JG-06](#)
[F416SYGWA/S530-E3](#) [1668](#) [HT-F196NB-5323](#) [IPD2131-27](#) [SA03-12EWA](#) [LDD-E2802RD](#) [LDD-E306MI](#) [LDQ-N514RI](#) [LDS-A3506RD](#)
[LDS-A3926RI](#) [LDT-M516RI](#) [SC03-12HDB](#) [SI-B9T151550WW](#) [SI-B9V171550WW](#) [SLC-3PF-WL](#) [1624](#) [LTC-2621JD](#) [LTC-2623WC](#) [LTC-](#)
[4624P](#) [LTC-4627JD](#) [LTD-2601E](#) [LTD-2601P](#) [LTD-322G](#) [LTD-482PC](#) [LTP-1457AKR](#) [LTP-3784G-01](#) [LTS-313AP](#) [LTS-4812SKR-P](#) [LTS-](#)
[547AE](#) [LTS-6780P](#) [446010401-3](#) [HV-7W30-6829](#) [CA12240_MINNIE-WWW-MTG-ASSY](#) [DA43-11GWA](#) [LDD-A516RI-17](#) [LDD-E305RI](#)
[LDQ-M513RI](#) [LDQ-M5204RI-SI](#) [LDQ-N3402RI](#) [LDQ-N3606RI](#) [LDT-M2804RI](#)