

■Description

- This LED builds with internal resistor to operate with wide operation voltage of DC3-15V
- 50pcs are supplied in a storage box
- Easy to use and storage, user-friendly
- Widely applied to project design, Arduino/Pi Pico/Steam kit, TTL/Cmos compatible applications

■Product Picture

50pcs/Box (Dimensions: 80*54*30mm)



■Features

- Wide Input Voltage
- Cost Saving and Space Saving
- Green Transparent Type
- Pure Green Color

■Applications

- Toys/Game/Audio
- TTL/Cmos Compatible
- Arduino/Pi Pico/Steam Kit
- Other Electronics Products

■Outline Dimension

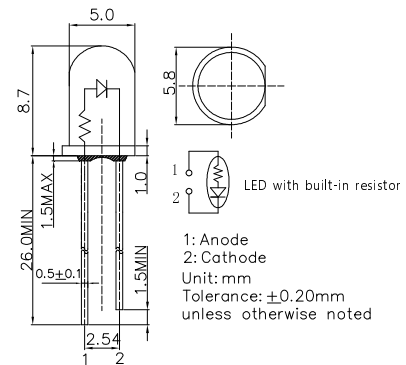

■Absolute Maximum Rating (Ta=25°C)

Item	Symbol	Value	Unit
DC Forward Voltage	V _F	15	V
Reverse Voltage	V _R	12	V
Power Dissipation	P _D	190	mW
Operating Temperature	T _{opr}	-30 ~ +85	°C
Storage Temperature	T _{stg}	-40~ +100	°C
Lead Soldering Temperature	T _{sol}	260°C/5sec	-

■Directivity

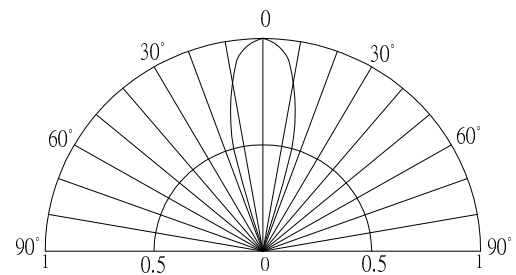

■Electrical -Optical Characteristics (Ta=25°C)

5mm Multi-Voltage LED	
LED P/N	OSG55133A-VV
Light Color	Pure Green
Lens Color	Green Transparent
Wavelength*1	520-530nm
Luminous Intensity(typ.)*2	5800mcd
Forward Voltage(typ.)	9V
Forward Current(typ.)*3	7.5mA
Viewing Angle(typ.)	30°
Quantity(pcs)/Box	50

*1 Tolerance of measurements of dominant wavelength is ±1nm
 *2 Tolerance of measurements of luminous intensity is ±15%
 *3 Tolerance of measurements of forward current ±1mA

■Optical Characteristic Curves

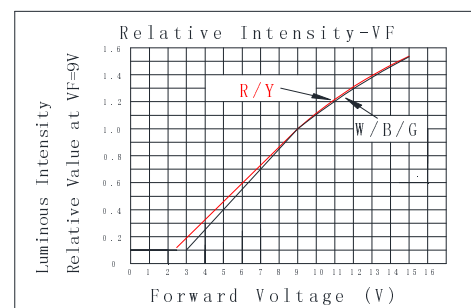

X-ON Electronics

Largest Supplier of Electrical and Electronic Components

Click to view similar products for [Optosupply](#) manufacturer:

Other Similar products are found below :

[OECCDD01-300](#) [OEHW2030GF](#) [OEHW2045GF](#) [OEHW2060GF](#) [OEHW2090GF](#) [OKLEDT3050G5V](#) [OKLEDT3050RBV](#)
[OKLEDT3050RBW](#) [OKLEDT3050RPV](#) [OKLEDT3050RPW](#) [OKLEDT3050WAW](#) [OKLEDT30606A](#) [OKLEDT3100B5](#) [OKLEDT3100G8](#)
[OKLEDT3100M3](#) [OKLEDT3100M4](#) [OKLEDT3100R6](#) [OKLEDT3100W6](#) [OKLEDT3100Y5](#) [OKLEDT31203A](#) [OKLEDT31206A](#)
[OKLEDT5050B5W](#) [OKLEDT5050G5W](#) [OKLEDT5050RBV](#) [OKLEDT5050RBW](#) [OKLEDT5050RPW](#) [OKLEDT5050TAW](#)
[OKLEDT5050WAV](#) [OKLEDT50606A](#) [OKLEDT50606B](#) [OKLEDT5100B5](#) [OKLEDT5100G8](#) [OKLEDT5100M3](#) [OKLEDT5100R6](#)
[OKLEDT5100W6](#) [OKLEDT5100WA](#) [OKLEDT5100Y5](#) [OKLEDT51203A](#) [OKLEDT8050G5V](#) [OKLEDT8050G5W](#) [OKLEDT8050M3V](#)
[OKLEDT8050R5V](#) [OKLEDT8050RBV](#) [OKLEDT8050RPW](#) [OKLEDT8050WAW](#) [OPDK-G5DA8B31F](#) [OPDK-W5DK8B31F](#) [OPDK-](#)
[Y5CA8B31F](#) [OPDO-M5DK8B31F](#) [OS2MDK3131A](#)