

■ Features

- High Luminous LEDs
- 3mm Round Standard Directivity
- UV Resistant Epoxy
- Color Transparent Type

■ Applications

- Electronic Signs and Signals
- Small Area Illuminations
- Back Lighting
- Other Lighting

■ Outline Dimension

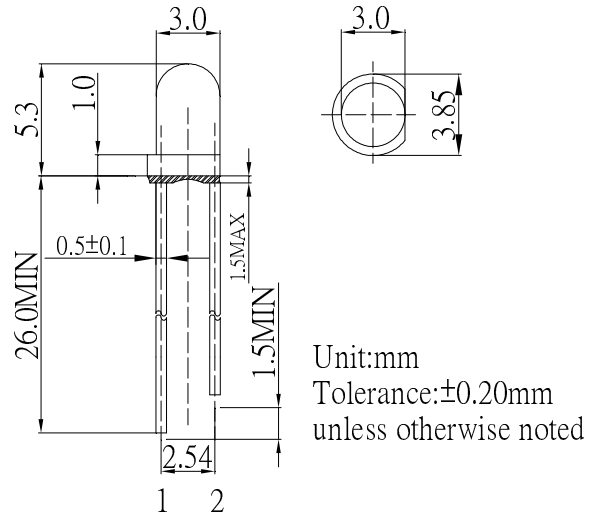

■ Absolute Maximum Rating

(Ta=25°C)

Item	Symbol	Value	Unit
DC Forward Current	I _F	30	mA
Pulse Forward Current#	I _{FP}	100	mA
Reverse Voltage	V _R	5	V
Power Dissipation	P _D	78	mW
Operating Temperature	T _{opr}	-30 ~ +85	°C
Storage Temperature	T _{stg}	-40~ +100	°C
Lead Soldering Temperature	T _{sol}	260°C/5sec	-

#Pulse width Max.10ms Duty ratio max 1/10

■ Directivity

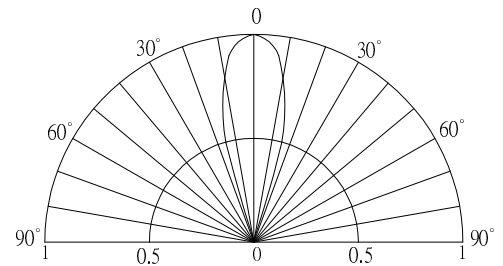

■ Electrical -Optical Characteristics

(Ta=25°C)

Item	Symbol	Condition	Min.	Typ.	Max.	Unit
DC Forward Voltage*1	V _F	I _F =20mA	1.8	2.1	2.6	V
DC Reverse Current	I _R	V _R =5V	-	-	10	μA
Domi. Wavelength*2	λ _D	I _F =20mA	620	625	630	nm
Luminous Intensity*3	I _v	I _F =20mA	500	750	-	mcd
50% Power Angle	2θ _{1/2}	I _F =20mA	-	30	-	deg

*1 Tolerance of measurements of forward voltage is ±0.1V

*2 Tolerance of measurements of dominant wavelength is ±1nm

*3 Tolerance of measurements of luminous intensity is ±15%

AlGaInP LED

TYPICAL ELECTRICAL/OPTICAL CHARACTERISTIC CURVES

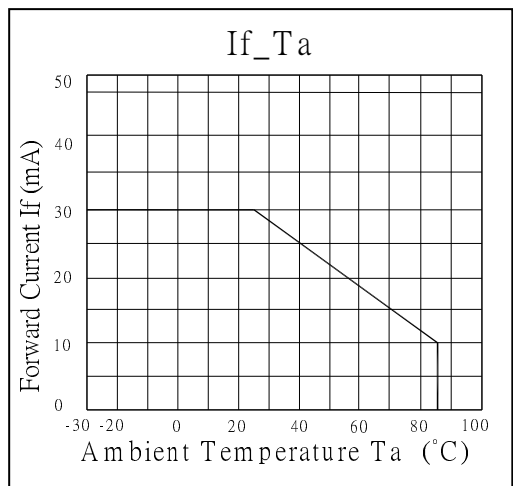
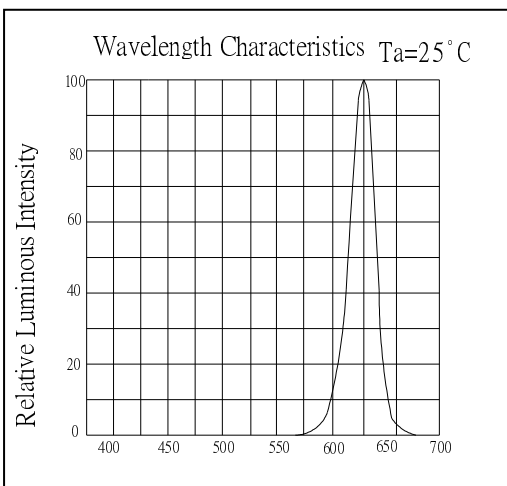
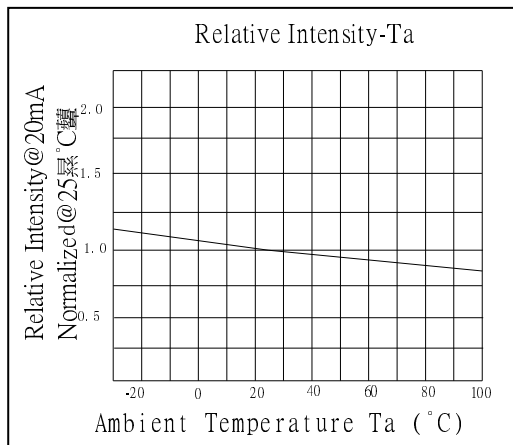
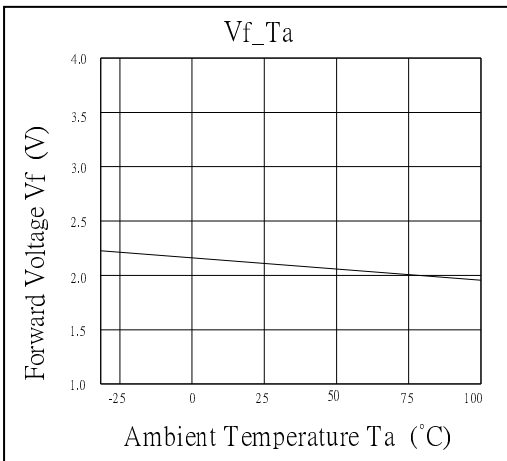
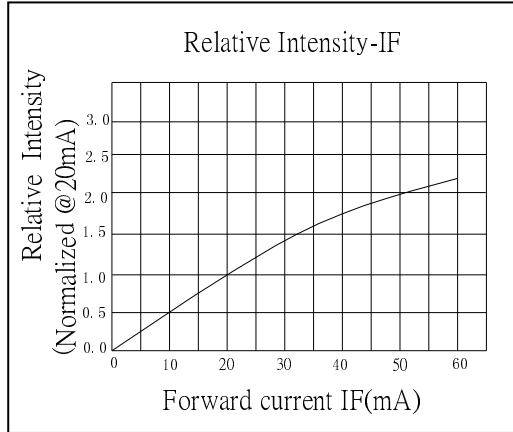
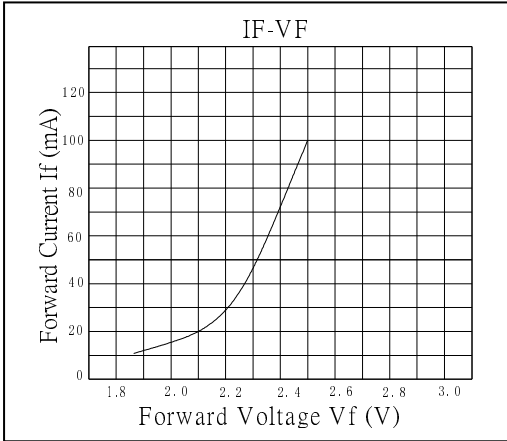

X-ON Electronics

Largest Supplier of Electrical and Electronic Components

Click to view similar products for [Standard LEDs - Through Hole category](#):

Click to view products by [Optosupply manufacturer](#):

Other Similar products are found below :

[LTL-10234W](#) [LTL-10254W](#) [LTL-1214A](#) [LTL-2231AT](#) [LTL2H3HRKL13](#) [LTL-3251A](#) [LTL-4262N](#) [LTL-5234](#) [LTL87HTBK](#) [LTW-87HD4B](#) [7383/V7C3-BSTA-L/PR3/MS](#) [1L0532V23G0TD001](#) [LNX998CKBDA](#) [LO566UHR3-70G-A3](#) [LP379PPG1C0G0300001](#) [SLR-322MCT32](#) [SLR-342VCTB7](#) [SLR343BCTT32](#) [SLX-LX3044GD](#) [SLX-LX3044ID](#) [SLX-LX3044YD](#) [SSS-LX4673ID-410B](#)
[1L0532Y24I0TD001](#) [264-7SYGD/S530-E2](#) [HLMP1385](#) [LTL-10224W](#) [LTL-1224A](#) [LTL-1BEHJ-012](#) [LU7-E-B](#) [4380H1](#) [TLHY44K1L2](#)
[484-10SYGT/S530-E2](#) [L53SRC/E-Z](#) [L-7679C1ZGC](#) [4302T1-5V](#) [4306D23](#) [4363D1/5](#) [WP1503SRC/J4](#) [WP153GDT](#) [WP153YDT](#)
[WP1543SGC](#) [WP1543SURC](#) [WP7113HD](#) [WP7113MBD](#) [WP7143SEC/H](#) [Z-221A](#) [ZD0172](#) [EALP05RDEWA2](#) [SLR-332MCT32](#) [SLR-342DU3F](#)