

**■ Features**

- High Luminous LEDs
- 3mm Concave Standard Directivity
- UV Resistant Epoxy
- Water Clear /Color Transparent/ Color Diffused Type

**■ Applications**

- TV Set
- Telephone
- Indicator
- Monitor

**■ Outline Dimension**

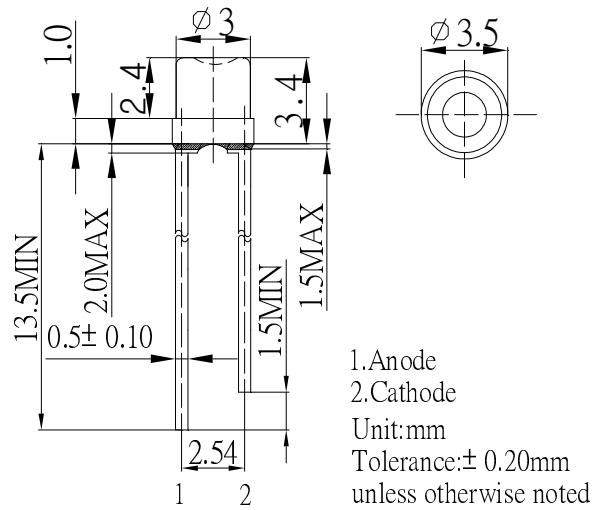

**■ Absolute Maximum Rating**

(Ta=25°C)

Item	Symbol	Value		Unit
		B/PG	Y/O/R	
DC Forward Current	I <sub>F</sub>	30	30	mA
Pulse Forward Current#	I <sub>FP</sub>	100	100	mA
Reverse Voltage	V <sub>R</sub>	5	5	V
Power Dissipation	P <sub>D</sub>	108	78	mW
Operating Temperature	Topr	-30 ~ +85		°C
Storage Temperature	Tstg	-40 ~ +100		°C
Lead Soldering Temperature	Tsol	260°C/5sec		-

**■ Directivity**

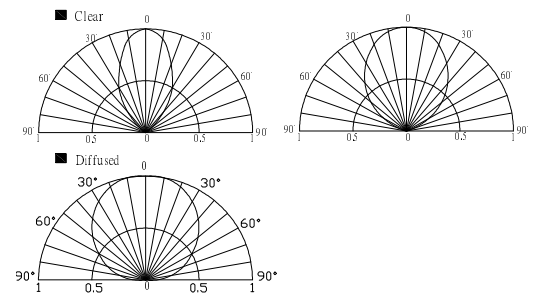

#Pulse width Max.10ms Duty ratio max 1/10

**■ Electrical -Optical Characteristics**

(Ta=25°C)





















Part Number	Color			V <sub>F</sub> (V)*			I <sub>R</sub> (μA)	I <sub>v</sub> (mcd)*			W <sub>d</sub> (nm)*			2θ1/2(deg)
				Min.	Typ.	Max.	Max.	Min.	Typ.	Max.	Min.	Typ.	Max.	Typ.
				I <sub>F</sub> =20mA			V <sub>R</sub> =5V			I <sub>F</sub> =20mA				
OSB5SA3P61A	Blue	B	■	2.8	3.1	3.6	10	500	750	-	465	470	475	60
OSG5DA3P61A	Pure Green	PG	■	2.8	3.1	3.6	10	1560	2180	-	520	525	530	60
OSG8NU3P81A	Yellow Green	YG	■	1.8	2.1	2.6	10	45	68	-	565	570	575	80
OSY5LU3P81A	Yellow	Y	■	1.8	2.1	2.6	10	150	220	-	585	590	595	80
OSY5JA3P81A	Yellow	Y	■	1.8	2.1	2.6	10	220	330	-	585	590	595	80
OSY5RU3P81A	Yellow	Y	■	1.8	2.1	2.6	10	220	330	-	585	590	595	80
OSO5JA3P81A	Orange	O	■	1.8	2.1	2.6	10	220	330	-	600	605	610	80
OSR5JA3P81A	Red	R	■	1.8	2.1	2.6	10	150	220	-	620	625	630	80
OSR5RU3P81A	Red	R	■	1.8	2.1	2.6	10	220	330	-	620	625	630	80
OSR6LU3P81A	Red	R	■	1.8	2.1	2.6	10	68	100	-	630	640	650	80

\*1 Tolerance of measurements of dominant wavelength is +1nm

\*2 Tolerance of measurements of luminous intensity is ±15%

\*3 Tolerance of measurements of forward voltage is ±0.1V

**■ Electrical -Optical Characteristics (Ta=25°C)**

Part Number	Color			V <sub>F</sub> (V)*			I <sub>R</sub> (μA)	I <sub>v</sub> (mcd)*			Wd(nm)*			2θ1/2(deg)
				Min.	Typ.	Max.	Max.	Min.	Typ.	Max.	Min.	Typ.	Max.	Typ.
				I <sub>F</sub> =20mA			V <sub>R</sub> =5V	I <sub>F</sub> =20mA						
OSB5SA3P63A	Blue	B		2.8	3.1	3.6	10	500	750	-	465	470	475	60
OSG5DA3P63A	Pure Green	PG		2.8	3.1	3.6	10	1560	2180	-	520	525	530	60
OSG8NU3P83A	Yellow Green	YG		1.8	2.1	2.6	10	45	68	-	565	570	575	80
OSY5LU3P83A	Yellow	Y		1.8	2.1	2.6	10	150	220	-	585	590	595	80
OSY5JA3P83A	Yellow	Y		1.8	2.1	2.6	10	220	330	-	585	590	595	80
OSY5RU3P83A	Yellow	Y		1.8	2.1	2.6	10	220	330	-	585	590	595	80
OSO5JA3P83A	Orange	O		1.8	2.1	2.6	10	220	330	-	600	605	610	80
OSR5JA3P83A	Red	R		1.8	2.1	2.6	10	150	220	-	620	625	630	80
OSR5RU3P83A	Red	R		1.8	2.1	2.6	10	220	330	-	620	625	630	80
OSR6LU3P83A	Red	R		1.8	2.1	2.6	10	68	100	-	630	640	650	80
OSB5SA3PC4A	Blue	B		2.8	3.1	3.6	10	150	220	-	465	470	475	120
OSG5DA3PC4A	Pure Green	PG		2.8	3.1	3.6	10	500	750	-	520	525	530	120
OSG8NU3PC4A	Yellow Green	YG		1.8	2.1	2.6	10	30	45	-	565	570	575	120
OSY5LU3PC4A	Yellow	Y		1.8	2.1	2.6	10	68	100	-	585	590	595	120
OSY5JA3PC4A	Yellow	Y		1.8	2.1	2.6	10	100	150	-	585	590	595	120
OSY5RU3PC4A	Yellow	Y		1.8	2.1	2.6	10	150	220	-	585	590	595	120
OSO5JA3PC4A	Orange	O		1.8	2.1	2.6	10	100	150	-	600	605	610	120
OSR5JA3PC4A	Red	R		1.8	2.1	2.6	10	100	150	-	620	625	630	120
OSR5RU3PC4A	Red	R		1.8	2.1	2.6	10	150	220	-	620	625	630	120
OSR6LU3PC4A	Red	R		1.8	2.1	2.6	10	45	68	-	630	640	650	120

\*1 Tolerance of measurements of dominant wavelength is ±1nm

\*2 Tolerance of measurements of luminous intensity is ±15%

\*3 Tolerance of measurements of forward voltage is ±0.1V

## X-ON Electronics

Largest Supplier of Electrical and Electronic Components

*Click to view similar products for [Standard LEDs - Through Hole category:](#)*

*Click to view products by [Optosupply manufacturer:](#)*

Other Similar products are found below :

[LTL-10234W](#) [LTL-10254W](#) [LTL-1214A](#) [LTL-2231AT](#) [LTL2H3HRKL13](#) [LTL-3251A](#) [LTL-4262N](#) [LTL-5234](#) [LTL87HTBK](#) [LTW-87HD4B](#) [7383/V7C3-BSTA-L/PR3/MS](#) [1L0532V23G0TD001](#) [LNX998CKBDA](#) [LO566UHR3-70G-A3](#) [LP379PPG1C0G0300001](#) [SLR-322MCT32](#) [SLR-342VCTB7](#) [SLR343BCTT32](#) [SLX-LX3044GD](#) [SLX-LX3044ID](#) [SLX-LX3044YD](#) [SSS-LX4673ID-410B](#)  
[1L0532Y24I0TD001](#) [264-7SYGD/S530-E2](#) [HLMP1385](#) [LTL-10224W](#) [LTL-1224A](#) [LTL-1BEHJ-012](#) [LU7-E-B](#) [4380H1](#) [TLHY44K1L2](#)  
[484-10SYGT/S530-E2](#) [L53SRC/E-Z](#) [L-7679C1ZGC](#) [4302T1-5V](#) [4306D23](#) [4363D1/5](#) [WP1503SRC/J4](#) [WP153GDT](#) [WP153YDT](#)  
[WP1543SGC](#) [WP1543SURC](#) [WP7113HD](#) [WP7113MBD](#) [WP7113MGC](#) [WP7143SEC/H](#) [Z-221A](#) [ZD0172](#) [EALP05RDEWA2](#) [SLR-332MCT32](#)