

■ Features

- High Luminous LEDs
- 10mm Round Standard Directivity
- UV Resistant Epoxy
- Variable Voltage LED
- Cost Effective (Saves Space and Resistor Cost)
- Water Clear Type

■ Applications

- Status Indicators
- Other Lighting

■ Outline Dimension

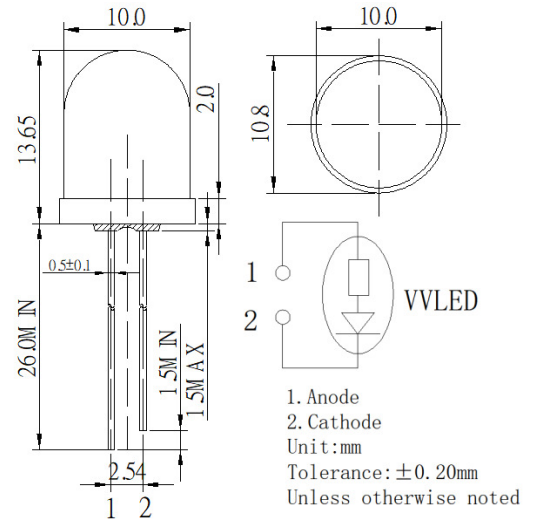

■ Absolute Maximum Rating

(Ta=25°C)

Item	Symbol	Value	Unit
DC Forward Voltage	V _F	16	V
Reverse Voltage	V _R	12	V
Power Dissipation	P _D	208	mW
Operating Temperature	Topr	-30 ~ +85	°C
Storage Temperature	Tstg	-30 ~ +85	°C
Lead Soldering Temperature	Tsol	260°C/5sec	-

■ Directivity

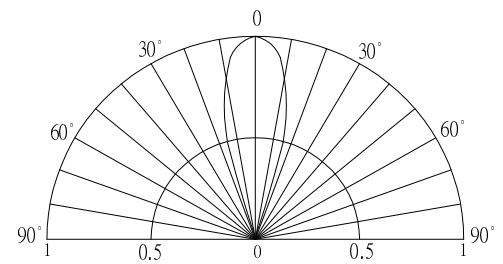

■ Electrical -Optical Characteristics

(Ta=25°C)

Part Number	Color		I _F (mA)*			I _v (mcd)*			λD(nm)*			2θ1/2(deg)
			Min	Typ.	Max.	Min.	Typ.	Max.	Min.	Typ.	Max.	Typ.
			V _F =9V			V _F =9V						
OSW54KA131A-VVLED	White	W	-	7.5	13	-	7000	-	8500-18000K(X:0.27,Y:0.28)			30
OSM54KA131A-VVLED	Warm White	M	-	7.5	13	-	5800	-	2700-3200K(X:0.45,Y:0.41)			30
OSB5DAA131A-VVLED	Blue	B	-	7.5	13	-	3000	-	465	470	475	30
OSG58AA131A-VVLED	Pure Green	G	-	7.5	13	-	7000	-	520	525	530	30
OSY5PAA131A-VVLED	Yellow	Y	-	8	13	-	4200	-	585	590	595	30
OSO5PAA131A-VVLED	Orange	O	-	8	13	-	4200	-	600	605	610	30
OSR5PAA131A-VVLED	Red	R	-	8	13	-	4200	-	620	625	630	30

*1 Tolerance of measurements of domi. wavelength is ±1nm
 *2 Tolerance of measurements of chromaticity coordinates is ±10%
 *3 Tolerance of measurements of luminous intensity is ±15%
 *4 Tolerance of measurements of forward voltage is ±0.1V

InGaN and Si Resistor LED

TYPICAL ELECTRICAL/OPTICAL CHARACTERISTIC CURVES

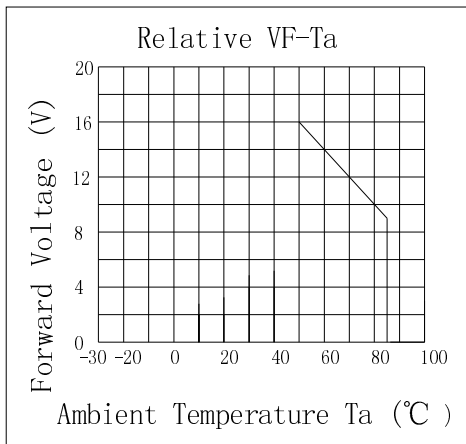
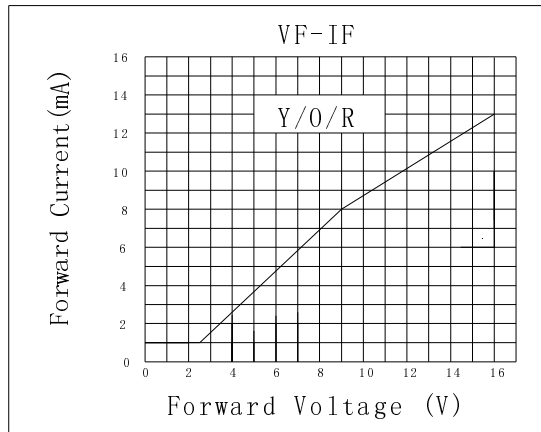
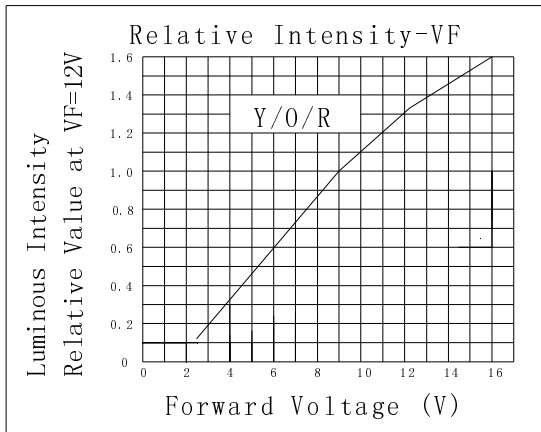
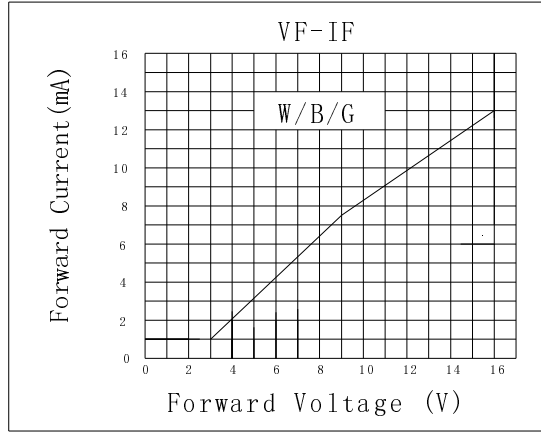
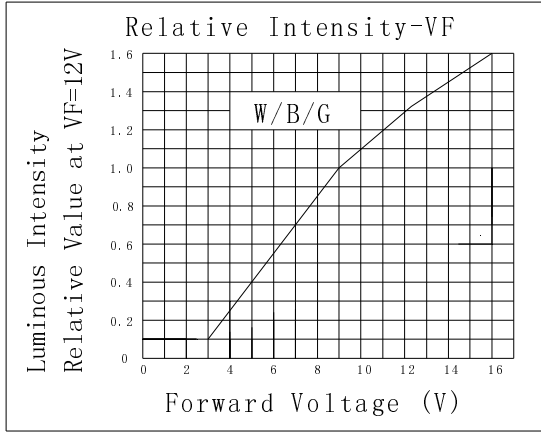

X-ON Electronics

Largest Supplier of Electrical and Electronic Components

Click to view similar products for [Standard LEDs - Through Hole category:](#)

Click to view products by [Optosupply manufacturer:](#)

Other Similar products are found below :

[LTL-10234W](#) [LTL-10254W](#) [LTL-1214A](#) [LTL-2231AT](#) [LTL2H3HRKL13](#) [LTL-3251A](#) [LTL-4262N](#) [LTL-5234](#) [LTL87HTBK](#) [LTW-87HD4B](#) [7383/V7C3-BSTA-L/PR3/MS](#) [1L0532V23G0TD001](#) [LNX998CKBDA](#) [LO566UHR3-70G-A3](#) [LP379PPG1C0G0300001](#) [SLR-322MCT32](#) [SLR-342VCTB7](#) [SLR343BCTT32](#) [SLX-LX3044GD](#) [SLX-LX3044ID](#) [SLX-LX3044YD](#) [SSS-LX4673ID-410B](#)
[1L0532Y24I0TD001](#) [264-7SYGD/S530-E2](#) [HLMP1385](#) [LTL-10224W](#) [LTL-1224A](#) [LTL-1BEHJ-012](#) [LU7-E-B](#) [4380H1](#) [TLHY44K1L2](#)
[484-10SYGT/S530-E2](#) [L53SRC/E-Z](#) [L-7679C1ZGC](#) [4302T1-5V](#) [4306D23](#) [4363D1/5](#) [WP1503SRC/J4](#) [WP153GDT](#) [WP153YDT](#)
[WP1543SGC](#) [WP1543SURC](#) [WP7113HD](#) [WP7113MBD](#) [WP7143SEC/H](#) [Z-221A](#) [ZD0172](#) [EALP05RDEWA2](#) [SLR-332MCT32](#) [SLR-342DU3F](#)