

■Description

This LED builds with internal resistor to operate with wide operation voltage of DC3-15V.

■Outline Dimension

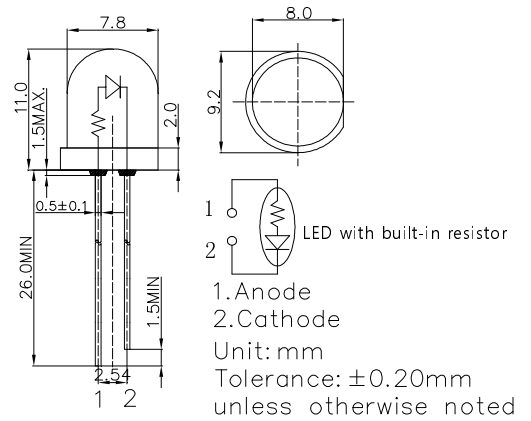

■Features

- Wide Input Voltage
- Cost Saving and Space Saving
- Diffused Type
- Single Color

■Applications

- Toys/Game/Audio
- TTL/Cmos Compatible
- Arduino/Pi Pico/Steam Kit
- Other Electronics Products

■Directivity

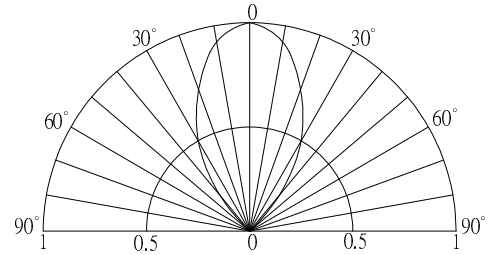

■Absolute Maximum Rating

(Ta=25°C)

Item	Symbol	Value	Unit
DC Forward Voltage	V _F	15	V
Reverse Voltage	V _R	12	V
Power Dissipation	P _D	190	mW
Operating Temperature	Topr	-30 ~ +85	°C
Storage Temperature	Tstg	-40~ +100	°C
Lead Soldering Temperature	Tsol	260°C/5sec	-

■Optical Characteristic Curves

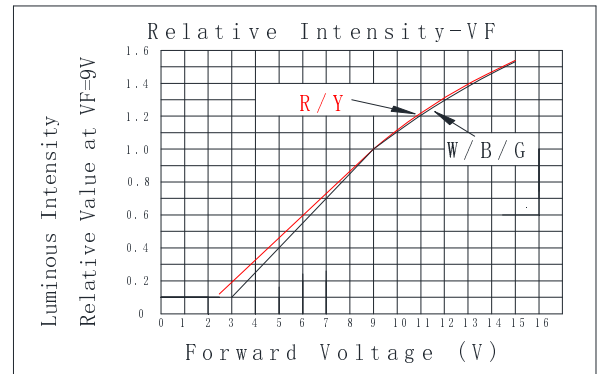

■Electrical -Optical Characteristics

(Ta=25°C)

8mm Multi-Voltage LED						
LED P/N	OSR58164A-VV	OSY58164A-VV	OSB58164A-VV	OSG58164A-VV	OSM58162A-VV	OSW58162A-VV
Light Color	Red	Yellow	Blue	Pure Green	Warm White	Cool White
Lens Color	Red Diffused	Yellow Diffused	Blue Diffused	Green Diffused	White Diffused	White Diffused
Wavelength*1/Color Temperature*2	620-630nm	585-595nm	465-475m	520-530nm	2700-3300K	8500-18000K
Luminous Intensity(typ.)*3	150mcd	150mcd	100mcd	400mcd	400mcd	400mcd
Forward Voltage(typ.)	9V	9V	9V	9V	9V	9V
Forward Current(typ.)	8mA	8mA	7.5mA	7.5mA	7.5mA	7.5mA
Viewing Angle(typ.)	60°	60°	60°	60°	60°	60°

*1 Tolerance of measurements of dominant wavelength is ±1nm

*2 Tolerance of measurements of color temperature is ±10%

*3 Tolerance of measurements of luminous intensity is ±15%

X-ON Electronics

Largest Supplier of Electrical and Electronic Components

Click to view similar products for [Optosupply](#) manufacturer:

Other Similar products are found below :

[OECCDD01-300](#) [OEHW2030GF](#) [OEHW2045GF](#) [OEHW2060GF](#) [OEHW2090GF](#) [OKLEDT3050G5V](#) [OKLEDT3050RBV](#)
[OKLEDT3050RBW](#) [OKLEDT3050RPV](#) [OKLEDT3050RPW](#) [OKLEDT3050WAW](#) [OKLEDT30606A](#) [OKLEDT3100B5](#) [OKLEDT3100G8](#)
[OKLEDT3100M3](#) [OKLEDT3100M4](#) [OKLEDT3100R6](#) [OKLEDT3100W6](#) [OKLEDT3100Y5](#) [OKLEDT31203A](#) [OKLEDT31206A](#)
[OKLEDT5050B5W](#) [OKLEDT5050G5W](#) [OKLEDT5050RBV](#) [OKLEDT5050RBW](#) [OKLEDT5050RPW](#) [OKLEDT5050TAW](#)
[OKLEDT5050WAV](#) [OKLEDT50606A](#) [OKLEDT50606B](#) [OKLEDT5100B5](#) [OKLEDT5100G8](#) [OKLEDT5100M3](#) [OKLEDT5100R6](#)
[OKLEDT5100W6](#) [OKLEDT5100WA](#) [OKLEDT5100Y5](#) [OKLEDT51203A](#) [OKLEDT8050G5V](#) [OKLEDT8050G5W](#) [OKLEDT8050M3V](#)
[OKLEDT8050R5V](#) [OKLEDT8050RBV](#) [OKLEDT8050RPW](#) [OKLEDT8050WAW](#) [OPDK-G5DA8B31F](#) [OPDK-W5DK8B31F](#) [OPDK-](#)
[Y5CA8B31F](#) [OPDO-M5DK8B31F](#) [OS2MDK3131A](#)