

■ Features

- High Luminous LEDs
- 3mm Concave Standard Directivity
- UV Resistant Epoxy
- Water Clear /Color Transparent/ Color Diffused Type

■ Applications

- TV Set
- Telephone
- Indicator
- Monitor

■ Outline Dimension

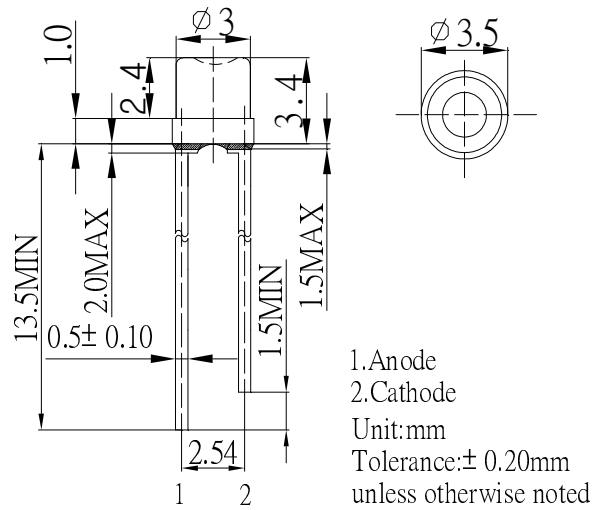

■ Absolute Maximum Rating

(Ta=25°C)

Item	Symbol	Value		Unit
		B/PG	Y/O/R	
DC Forward Current	I _F	30	30	mA
Pulse Forward Current#	I _{FP}	100	100	mA
Reverse Voltage	V _R	5	5	V
Power Dissipation	P _D	108	78	mW
Operating Temperature	Topr	-30 ~ +85		°C
Storage Temperature	Tstg	-40 ~ +100		°C
Lead Soldering Temperature	Tsol	260°C/5sec		-

■ Directivity

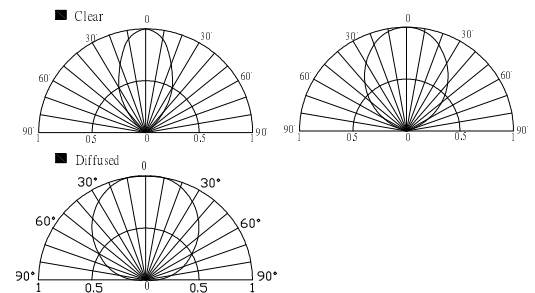

#Pulse width Max.10ms Duty ratio max 1/10

■ Electrical -Optical Characteristics

(Ta=25°C)





















Part Number	Color			V _F (V)*			I _R (μA)	I _v (mcd)*			W _d (nm)*			2θ1/2(deg)
				Min.	Typ.	Max.	Max.	Min.	Typ.	Max.	Min.	Typ.	Max.	Typ.
				I _F =20mA			V _R =5V			I _F =20mA				
OSB5SA3P61A	Blue	B	■	2.8	3.1	3.6	10	500	750	-	465	470	475	60
OSG5DA3P61A	Pure Green	PG	■	2.8	3.1	3.6	10	1560	2180	-	520	525	530	60
OSG8NU3P81A	Yellow Green	YG	■	1.8	2.1	2.6	10	45	68	-	565	570	575	80
OSY5LU3P81A	Yellow	Y	■	1.8	2.1	2.6	10	150	220	-	585	590	595	80
OSY5JA3P81A	Yellow	Y	■	1.8	2.1	2.6	10	220	330	-	585	590	595	80
OSY5RU3P81A	Yellow	Y	■	1.8	2.1	2.6	10	220	330	-	585	590	595	80
OSO5JA3P81A	Orange	O	■	1.8	2.1	2.6	10	220	330	-	600	605	610	80
OSR5JA3P81A	Red	R	■	1.8	2.1	2.6	10	150	220	-	620	625	630	80
OSR5RU3P81A	Red	R	■	1.8	2.1	2.6	10	220	330	-	620	625	630	80
OSR6LU3P81A	Red	R	■	1.8	2.1	2.6	10	68	100	-	630	640	650	80

*1 Tolerance of measurements of dominant wavelength is +1nm

*2 Tolerance of measurements of luminous intensity is ±15%

*3 Tolerance of measurements of forward voltage is ±0.1V

■ **Electrical -Optical Characteristics** (Ta=25°C)

Part Number	Color			V _F (V)*			I _R (μA)	I _v (mcd)*			Wd(nm)*			2θ1/2(deg)
				Min.	Typ.	Max.	Max.	Min.	Typ.	Max.	Min.	Typ.	Max.	Typ.
				I _F =20mA			V _R =5V	I _F =20mA						
OSB5SA3P63A	Blue	B		2.8	3.1	3.6	10	500	750	-	465	470	475	60
OSG5DA3P63A	Pure Green	PG		2.8	3.1	3.6	10	1560	2180	-	520	525	530	60
OSG8NU3P83A	Yellow Green	YG		1.8	2.1	2.6	10	45	68	-	565	570	575	80
OSY5LU3P83A	Yellow	Y		1.8	2.1	2.6	10	150	220	-	585	590	595	80
OSY5JA3P83A	Yellow	Y		1.8	2.1	2.6	10	220	330	-	585	590	595	80
OSY5RU3P83A	Yellow	Y		1.8	2.1	2.6	10	220	330	-	585	590	595	80
OSO5JA3P83A	Orange	O		1.8	2.1	2.6	10	220	330	-	600	605	610	80
OSR5JA3P83A	Red	R		1.8	2.1	2.6	10	150	220	-	620	625	630	80
OSR5RU3P83A	Red	R		1.8	2.1	2.6	10	220	330	-	620	625	630	80
OSR6LU3P83A	Red	R		1.8	2.1	2.6	10	68	100	-	630	640	650	80
OSB5SA3PC4A	Blue	B		2.8	3.1	3.6	10	150	220	-	465	470	475	120
OSG5DA3PC4A	Pure Green	PG		2.8	3.1	3.6	10	500	750	-	520	525	530	120
OSG8NU3PC4A	Yellow Green	YG		1.8	2.1	2.6	10	30	45	-	565	570	575	120
OSY5LU3PC4A	Yellow	Y		1.8	2.1	2.6	10	68	100	-	585	590	595	120
OSY5JA3PC4A	Yellow	Y		1.8	2.1	2.6	10	100	150	-	585	590	595	120
OSY5RU3PC4A	Yellow	Y		1.8	2.1	2.6	10	150	220	-	585	590	595	120
OSO5JA3PC4A	Orange	O		1.8	2.1	2.6	10	100	150	-	600	605	610	120
OSR5JA3PC4A	Red	R		1.8	2.1	2.6	10	100	150	-	620	625	630	120
OSR5RU3PC4A	Red	R		1.8	2.1	2.6	10	150	220	-	620	625	630	120
OSR6LU3PC4A	Red	R		1.8	2.1	2.6	10	45	68	-	630	640	650	120

*1 Tolerance of measurements of dominant wavelength is ±1nm

*2 Tolerance of measurements of luminous intensity is ±15%

*3 Tolerance of measurements of forward voltage is ±0.1V

X-ON Electronics

Largest Supplier of Electrical and Electronic Components

Click to view similar products for [Optosupply](#) manufacturer:

Other Similar products are found below :

[OECCDD01-300](#) [OEHW2030GF](#) [OEHW2045GF](#) [OEHW2060GF](#) [OEHW2090GF](#) [OKLEDT3050G5V](#) [OKLEDT3050RBV](#)
[OKLEDT3050RBW](#) [OKLEDT3050RPV](#) [OKLEDT3050RPW](#) [OKLEDT3050WAW](#) [OKLEDT30606A](#) [OKLEDT3100B5](#) [OKLEDT3100G8](#)
[OKLEDT3100M3](#) [OKLEDT3100M4](#) [OKLEDT3100R6](#) [OKLEDT3100W6](#) [OKLEDT3100Y5](#) [OKLEDT31203A](#) [OKLEDT31206A](#)
[OKLEDT5050B5W](#) [OKLEDT5050G5W](#) [OKLEDT5050RBV](#) [OKLEDT5050RBW](#) [OKLEDT5050RPW](#) [OKLEDT5050TAW](#)
[OKLEDT5050WAV](#) [OKLEDT50606A](#) [OKLEDT50606B](#) [OKLEDT5100B5](#) [OKLEDT5100G8](#) [OKLEDT5100M3](#) [OKLEDT5100R6](#)
[OKLEDT5100W6](#) [OKLEDT5100WA](#) [OKLEDT5100Y5](#) [OKLEDT51203A](#) [OKLEDT8050G5V](#) [OKLEDT8050G5W](#) [OKLEDT8050M3V](#)
[OKLEDT8050R5V](#) [OKLEDT8050RBV](#) [OKLEDT8050RPW](#) [OKLEDT8050WAW](#) [OPDK-G5DA8B31F](#) [OPDK-W5DK8B31F](#) [OPDK-](#)
[Y5CA8B31F](#) [OPDO-M5DK8B31F](#) [OS2MDK3131A](#)