

**■Features**

- High Luminous LEDs
- 4.7x5.7mm Standard Directivity
- UV Resistant Epoxy
- Water Clear Type

**■Applications**

- Electronic Signs And Signals
- Small Area Illuminations
- Back Lighting
- Other Lighting

**■Outline Dimension**

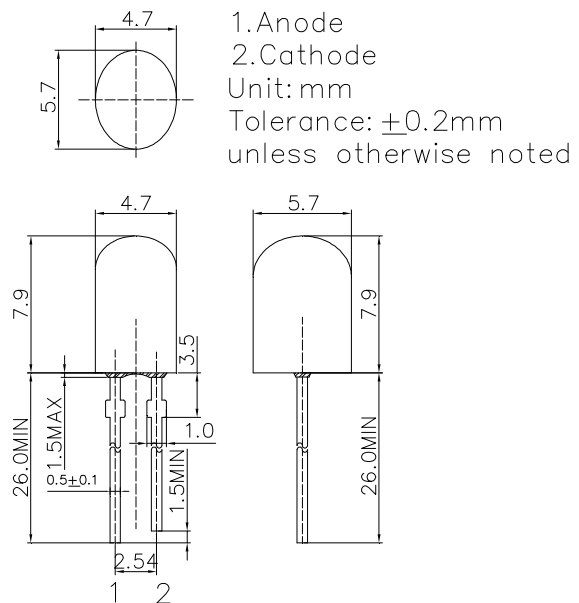

**■Absolute Maximum Rating**

(Ta=25°C)

Item	Symbol	Value	Unit
DC Forward Current	I <sub>F</sub>	50	mA
Pulse Forward Current#	I <sub>FP</sub>	120	mA
Reverse Voltage	V <sub>R</sub>	5	V
Power Dissipation	P <sub>D</sub>	120	mW
Operating Temperature	T <sub>opr</sub>	-30~ +85	°C
Storage Temperature	T <sub>stg</sub>	-40 ~ +100	°C
Lead Soldering Temperature	T <sub>sol</sub>	260°C/5sec	-

**■Directivity**

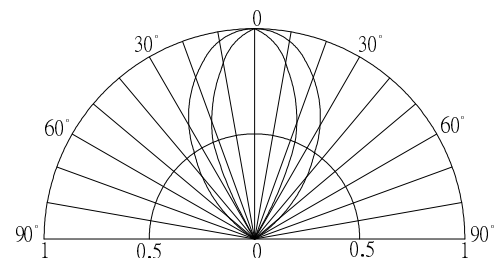

#Pulse width Max.10ms , Duty ratio max 1/10

**■Electrical -Optical Characteristics**

(Ta=25°C)

Item	Symbol	Condition	Min.	Typ.	Max.	Unit
DC Forward Voltage*1	V <sub>F</sub>	I <sub>F</sub> =20mA	-	2.1	2.4	V
DC Reverse Current	I <sub>R</sub>	V <sub>R</sub> =5V	-	-	10	μA
Domi. Wavelength*2	λ <sub>D</sub>	I <sub>F</sub> =20mA	585	590	595	nm
Luminous Intensity*3	I <sub>v</sub>	I <sub>F</sub> =20mA	4200	5800	-	mcd
50% Power Angle	2θ <sub>1/2</sub>	I <sub>F</sub> =20mA	-	40/70	-	deg

\*1 Tolerance of measurements of forward voltage is  $\pm 0.1$ V

\*2 Tolerance of measurements of dominant wavelength is  $\pm 1$ nm

\*3 Tolerance of measurements of luminous intensity is  $\pm 15$ %

## X-ON Electronics

Largest Supplier of Electrical and Electronic Components

*Click to view similar products for [Standard LEDs - Through Hole category](#):*

*Click to view products by [Optosupply manufacturer](#):*

Other Similar products are found below :

[LTL-10234W](#) [LTL-10254W](#) [LTL-1214A](#) [LTL-2231AT](#) [LTL2H3HRKL13](#) [LTL-3251A](#) [LTL-4262N](#) [LTL-5234](#) [LTL87HTBK](#) [LTW-87HD4B](#) [7383/V7C3-BSTA-L/PR3/MS](#) [1L0532V23G0TD001](#) [LNX998CKBDA](#) [LO566UHR3-70G-A3](#) [LP379PPG1C0G0300001](#) [SLR-322MCT32](#) [SLR-342VCTB7](#) [SLR343BCTT32](#) [SLX-LX3044GD](#) [SLX-LX3044ID](#) [SLX-LX3044YD](#) [SSS-LX4673ID-410B](#)  
[1L0532Y24I0TD001](#) [264-7SYGD/S530-E2](#) [HLMP1385](#) [LTL-10224W](#) [LTL-1224A](#) [LTL-1BEHJ-012](#) [LU7-E-B](#) [4380H1](#) [TLHY44K1L2](#)  
[484-10SYGT/S530-E2](#) [L53SRC/E-Z](#) [L-7679C1ZGC](#) [4302T1-5V](#) [4306D23](#) [4363D1/5](#) [WP1503SRC/J4](#) [WP153GDT](#) [WP153YDT](#)  
[WP1543SGC](#) [WP1543SURC](#) [WP7113HD](#) [WP7113MBD](#) [WP7143SEC/H](#) [Z-221A](#) [ZD0172](#) [EALP05RDEWA2](#) [SLR-332MCT32](#) [SLR-342DU3F](#)