

Cree High Power Starboards

Power of Cree in Standard and Custom LED Starboards

Data Sheet

Version 1.3

Lean & Fast. Made Smarter.

Superior Performance – Stay current with the highest intensity LEDs

Design Faster – Use industry standard starboards to shorten development time

Maximum Flexibility – Design to your exact specifications using NewEnergy starboards

Rapid Innovation – Work with NewEnergy on your custom solution

Primary Applications



Prototyping	Directional
Flashlight	Horticulture
Downlight	Portable
Architectural	Vehicle

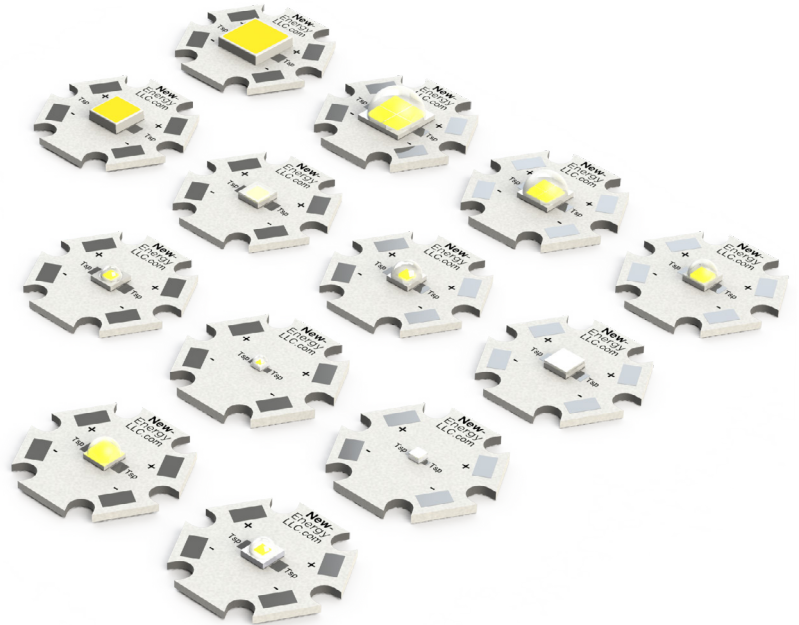

Custom Solutions

NewEnergy operates facilities globally with ISO certifications for the LED lighting, automotive and medical industries. Our North Carolina based office provides quick engineering & sales support with a R&D lab for prototype development and custom solutions. Our in-house global manufacturing capabilities allow for both building in the United States as well as overseas at scale.

About NewEnergy

NewEnergy accelerates the adoption of LED technology through simple, modular products and custom designs. Through 30 years of experience, state of the art manufacturing, full traceability and advanced quality controls, NewEnergy offers leading solid state lighting components, modules and custom solutions. NewEnergy customers get to market faster, with less resources, at lower costs. Visit new-energyllc.com for more information.

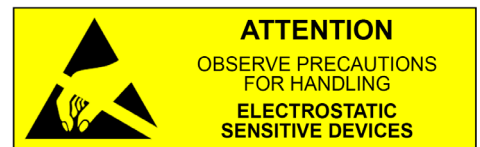

RoHS 

Cree High Power Starboards

White Product Selection Guide

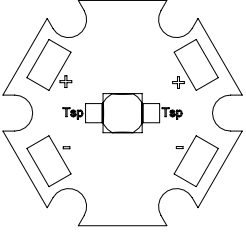
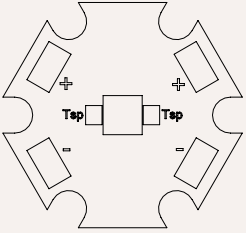
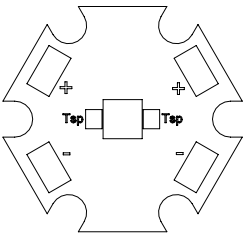
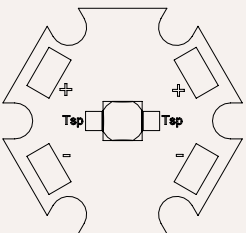
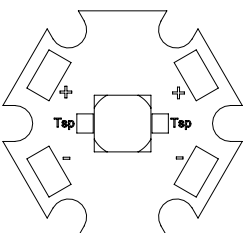
Product Family	Part Number	CCT	CRI	Luminous Flux (lm)
 <p>XHP35 HD</p>	XHP35A-00-0000-0D0BD430E-SB01	3000K	70	550
	XHP35A-00-0000-0D0BE240E-SB01	4000K	70	590
	XHP35A-00-0000-0D0BE450E-SB01	5000K	70	635
 <p>XHP35 HI</p>	XHP35A-H0-0000-0D0BC230E-SB01	3000K	70	440
	XHP35A-H0-0000-0D0BC440E-SB01	4000K	70	475
	XHP35A-H0-0000-0D0BC450E-SB01	5000K	70	475
 <p>XP-L HI</p>	XPLAWT-H0-0000-000HU40F8-SB01	2850K	80	340
	XPLAWT-H0-0000-000BV20E5-SB01	4000K	70	400
	XPLAWT-H0-0000-000BV20E1-SB01	6500K	70	400
 <p>XP-L HD</p>	XPLAWT-00-0000-000HU60E8-SB01	2700K	80	380
	XPLAWT-00-0000-000BV50E5-SB01	4000K	70	460
	XPLAWT-00-0000-000OV60E1-SB01	6500K	65	480
 <p>XHP50</p>	XHP50A-00-0000-0D0BJ440E-SB01	4000K	70	1120
	XHP50A-00-0000-0D0BJ450E-SB01	5000K	70	1120

Product performance at binning current $T_c = 85^\circ\text{C}$.
CRI and Flux values are minimum.

Cree High Power Starboards

White Product Selection Guide

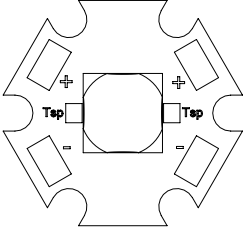
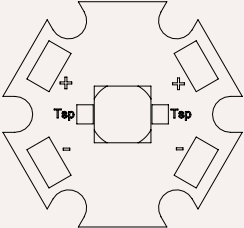
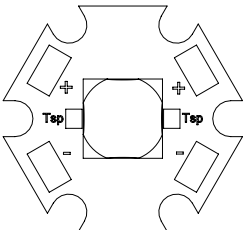
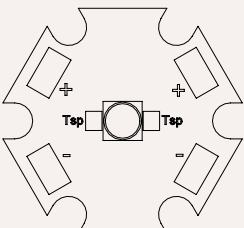
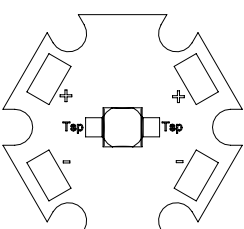
Product Family	Part Number	CCT	CRI	Luminous Flux (lm)
 XHP70	XHP70A-00-0000-0D0BM430E-SB01	3000K	70	1485
	XHP70A-00-0000-0D0BN240E-SB01	4000K	70	1590
	XHP70A-00-0000-0D0BN450E-SB01	5000K	70	1710
 XHP50.2	XHP50B-00-0000-0D0HH227G-SB01	2700K	80	900
	XHP50B-00-0000-0D0BJ440E-SB01	4000K	70	1120
	XHP50B-00-0000-0D0BJ40CB-SB01	6500K	70	1120
 XHP70.2	XHP70B-00-0000-0D0HM427G-SB01	2700K	80	1485
	XHP70B-00-0000-0D0BP240E-SB01	4000K	70	1830
	XHP70B-00-0000-0D0BN40E1-SB01	6500K	70	1710
 XP-G3	XPGDWT-H1-0000-00HE8-SB01	2700K	80	139
	XPGDWT-B1-0000-00L5E-SB01	4000K	70	164
	XPGDWT-01-0000-00LE1-SB01	6500K	70	164
 XP-L2	XPLBWT-00-0000-000HV227G-SB01	2700K	80	400
	XPLBWT-00-0000-000BV640E-SB01	4000K	70	480
	XPLBWT-00-0000-000BV50CB-SB01	6500K	70	460

Product performance at binning current $T_c = 85^\circ\text{C}$.
CRI and Flux values are minimum.

Cree High Power Starboards

White Product Selection Guide

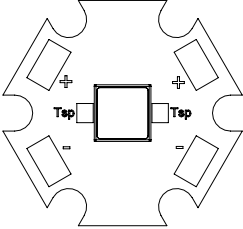
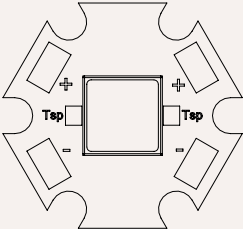
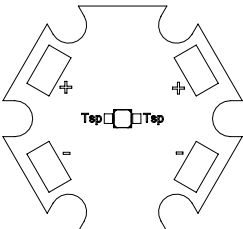
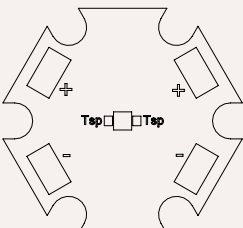
Product Family	Part Number	CCT	CRI	Luminous Flux (lm)
 <p>MHB-B</p>	MHBBWT-0000-000C0HC427G-SB01	2700K	80	475
	MHBBWT-0000-000C0BE240E-SB01	4000K	70	590
	MHBBWT-0000-000C0BE265E-SB01	6500K	70	590
 <p>MHD-G</p>	MHDCWT-0000-000N0HK427G-SB01	2700K	80	1290
	MHDCWT-0000-000N0BM440E-SB01	4000K	70	1485
	MHDCWT-0000-000N0BN265E-SB01	6500K	70	1590
 <p>XQ-E HD</p>	XQEAWT-00-0000-00000HBE8-SB01	2700K	80	93.9
	XQEAWT-00-0000-00000HDE5-SB01	4000K	80	107
	XQEAWT-00-0000-00000BFE1-SB01	6500K	70	122
 <p>XQ-E HI</p>	XQEAWT-H0-0000-00000HDE8-SB01	2700K	80	93.9
	XQEAWT-H0-0000-00000LEE5-SB01	4000K	75	114
	XQEAWT-H0-0000-00000BFE1-SB01	6500K	70	122

Product performance at binning current $T_c = 85^\circ\text{C}$.
CRI and Flux values are minimum.

Cree High Power Starboards

Color Product Selection Guide

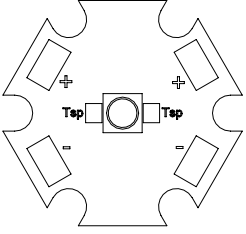

Product Family	Part Number	Color	DW/Bin	Luminous Flux (lm)
XPEBAM	XPEBAM-L1-0000-00901-SB01	Amber	585-595	80.6
XPEBBL	XPEBBL-L1-0000-00301-SB01	Blue	465-485	45.7
XPEBGR	XPEBGR-L1-0000-00G01-SB01	Green	520-535	130
XPEBGR	XPEBGR-L1-0000-00F03-SB01	Green	525-535	122
XPEBRD	XPEBRD-L1-0000-00901-SB01	Red	620-630	80.6
XPEBPA	XPEBPA-L1-0000-00D01-SB01	PC Amber	Y2	107

Specialty Color Product Selection Guide

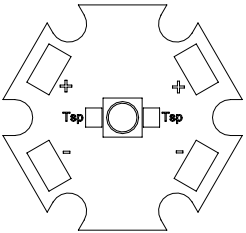

Product Family	Part Number	Color	DW/Bin	Radiant Flux (mW)
XPEBFR	XPEBFR-L1-0000-00901-SB01	Far Red	720-740	350
XPEPHR	XPEPHR-L1-0000-00901-SB01	Photo Red	650-670	350
XPEBRY	XPEBRY-L1-0000-00R01-SB01	Royal Blue	450-465	625
XPEBRD	XPERDO-L1-0000-00A01-SB01	Red Orange	610-620	87.4
XPGDRY	LSTI-01C32-RYL1-00	Royal Blue	440-455	730
XQEROY	LSTI-01C40-RYL1-00	Royal Blue	450-465	600
XQEEPR	LSTI-01C40-PRD1-00	HE Photo Red	650-670	375

Product performance at binning current $T_c = 85^\circ\text{C}$.
Flux values are minimum.

NewEnergy Starboard Mechanical

(Units: Inches)

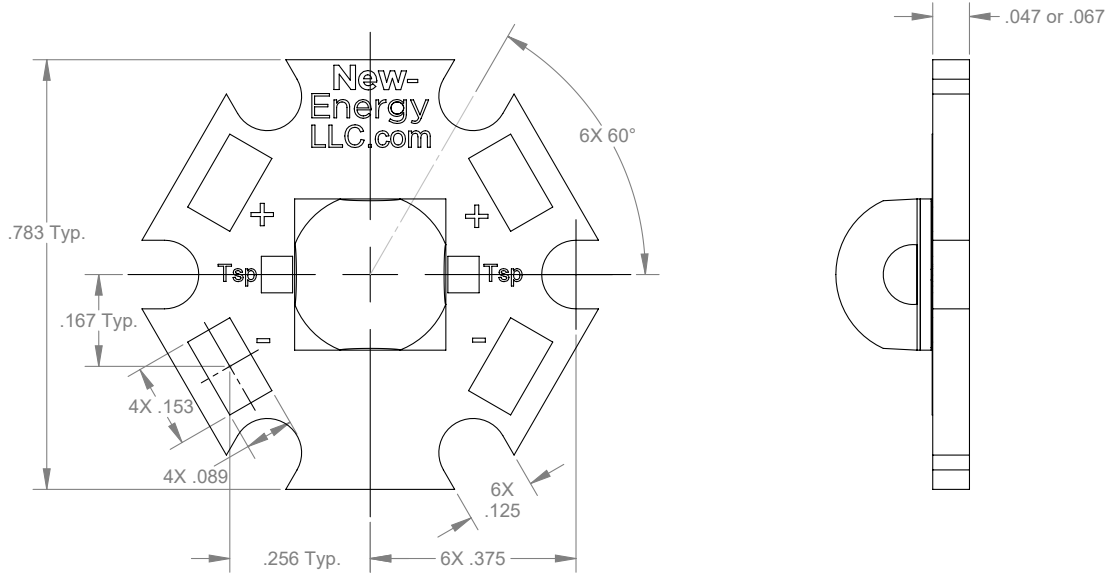

MCPCB Fabrication

- 2oz copper
- 5052 Al
- White solder mask
- Lead free Immersion Gold

Intended for connection to a class 2 power source with a maximum operating voltage of 50 Vdc.

X-ON Electronics

Largest Supplier of Electrical and Electronic Components

Click to view similar products for [High Power LEDs - White category](#):

Click to view products by [Opulent manufacturer](#):

Other Similar products are found below :

[LTW-K140SZR40](#) [B42180-08](#) [STW8Q2PA-R5-HA](#) [LTPL-P00DWS57](#) [LTW-K140SZR30](#) [LZP-D0WW00-0000](#) [SZ5-M1-WW-C8-V1/V3-FA](#) [LTW-K140SZR57](#) [LTW-K140SZR27](#) [BXRE-50C2001-C-74](#) [MP-5050-8100-27-80](#) [MP-5050-6100-65-80](#) [MP-5050-6100-40-80](#) [MP-5050-6100-30-80](#) [KW DPLS32.SB-6H6J-E5P7-EG-Z264](#) [L1V1-507003V500000](#) [KW DMLS33.SG-Z6M7-EBVFFCBB46-8E8G-700-S](#) [ASMT-MW05-NMNS1](#) [KW DPLS33.KD-HIJG-D30D144-HN-22C2-120-S](#) [KW DDLM31.EH-5J6K-A737-W4A4-140-R18](#) [GW](#) [JTLRS1.CM-K1LW-XX57-1-100-Q-R33](#) [KW DDLM31.EH-5J6K-A636-W4A4-140-R18](#) [KW DDLM31.EH-5J6K-A131-W4A4-140-R18](#) [SML-LXL8047MWCTR/3](#) [L2C5-40HG1203E0900](#) [JB3030AWT-P-U27EA0000-N0000001](#) [JK3030AWT-P-U30EA0000-N0000001](#) [JK3030AWT-P-B40EB0000-N0000001](#) [JK3030AWT-P-H30EB0000-N0000001](#) [JK3030AWT-P-H40EB0000-N0000001](#) [JK3030AWT-P-U27EB0000-N0000001](#) [JK3030AWT-P-U30EB0000-N0000001](#) [XPGBWT-HE-0000-00JE5](#) [GW JCLPS2.EM-H3H8-A131-1-65-2-R33](#) [GW](#) [PUSTA1.PM-PAPC-XX53-1-1050-R18](#) [BXRE-30E4000-C-83](#) [BXRE-50C6501-D-84](#) [BXRE-27E1000-B-83](#) [BXRE-30G0800-D-83](#) [BXRE-50C4001-B-84](#) [BXRH-40E4000-F-83](#) [BXRH-27G4000-F-83](#) [BXRE-27E4000-B-83](#) [BXRE-27E4000-C-83](#) [BXRE-27G30H0-D-82](#) [BXRE-27G4000-B-83](#) [BXRE-40E1000-B-83](#) [BXRE-40E6500-D-83](#) [BXRH-27E1000-B-83](#) [BXRH-27E4000-F-83](#)