



ORIENT

Photo coupler

Product Data Sheet

Part Number: OR-3H7

Customer: _____

Date: _____

SHENZHEN ORIENT COMPONENTS CO.,LTD.

Block A 3rd Floor No.4 Building, Tian'an Cyber Park, Huangge Rd, LongGangDist, Shenzhen, GD

TEL: 0755-29681816

FAX: 0755-29681200

www.orient-opto.com

1. Features

1. Current transfer ratio(CTR) : MIN. 50% at $I_F = 5\text{mA}$, $V_{CE} = 5\text{V}$, $T_a=25^\circ\text{C}$
2. High input-output isolation voltage. ($V_{ISO}=3,750\text{Vrms}$)
3. Collector and emitter Voltage : 80V(MIN)
4. Operating Temperature : -55°C to 125°C
5. Lead free, in compliance with RoHS standards
6. MSL Class I



2. Instructions

The OR-3H7 series device contains an infrared led and a photo transistor detector. They are encapsulated in a 4-pin SOP, free of halogens and Sb_2O_3

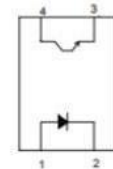

1 Anode 2 Cathode
3 Emitter 4 Collector

3. Application Range

1. Mixed PCB substrate requiring high density installation
2. Programmable controller
3. System apparatus and measuring instruments

4. Max Absolute rated Value (Normal Temperature= 25°C)

Parameter		Symbol	Rated Value	Unit
Input	Forward Current	I_F	50	mA
	Peak forward current($t=10\mu\text{s}$)	I_{FM}	1	A
	Reverse Voltage	V_R	6	V
	Power Dissipation	P	70	mW
	Junction Temperature	T_j	125	$^\circ\text{C}$
Output	Collector and emitter Voltage	V_{CEO}	80	V
	Emitter and collector Voltage	V_{ECO}	7	
	Collector Current	I_C	50	mA
	Power Dissipation	P_C	150	mW
	Junction Temperature	T_j	125	$^\circ\text{C}$
Total Power Dissipation		P_{tot}	200	mW
*1 Insulation Voltage		V_{iso}	3750	Vrms
Rated Impulse Insulation Voltage		V_{IORM}	630	V
Operating Temperature		T_{opr}	-55 to + 125	$^\circ\text{C}$
Storage Temperature		T_{stg}	-55 to + 150	
*2 Soldering Temperature		T_{sol}	260	

*1. AC For 1 Minute, R.H. = 40 ~ 60%

Isolation voltage shall be measured using the following method.

- (1) Short between anode and cathode on the primary side and between collector and emitter on the secondary side
- (2) The isolation voltage tester with zero-cross circuit shall be used.
- (3) The waveform of applied voltage shall be a sine wave.

*2.soldering time is 10 seconds

5. Opto-electronic Characteristics(Normal Temperature=25°C)

Parameter		Symbol	Condition	Min	Typ. *	Max	Unit
Input	Forward Voltage	V_F	$I_F=20mA$	---	1.2	1.4	V
	Reverse Current	I_R	$V_R=5V$	---	---	5	μA
	Terminal Capacitance	C_t	$V=0, f=1KHz$	---	30	250	pF
Output	Collector Dark Current	I_{CEO}	$V_{CE}=20V$ $I_F=0mA$	---	---	100	nA
	Collector-Emitter Breakdown Voltage	BV_{CEO}	$I_C=0.1mA$ $I_F=0mA$	80	---	---	V
	Emitter-Collector Breakdown Voltage	BV_{ECO}	$I_E=0.1mA$ $I_F=0mA$	7	---	---	V
Transforming Characteristics	*1 Current Transfer Ratio	CTR	$I_F=5mA$ $V_{CE}=5V$	50	---	600	%
	Collector Current	I_C		2.5	---	30	mA
	*1 Current Transfer Ratio	CTR	$I_F=0.5mA$ $V_{CE}=5V$	100	---	600	%
	Collector Current	I_C		0.5	---	3	mA
	Collector-Emitter Saturation Voltage	$V_{CE(sat)}$	$I_F=8mA$ $I_C=2.4mA$	---	---	0.4	V
	Insulation Impedance	R_{iso}	DC500V 40~60%R.H.	5×10^{10}	1×10^{11}	---	Ω
	Floating Capacitance	C_f	$V=0, f=1MHz$	---	0.6	1	pF
	Response Time	t_r	$V_{CE}=5V,$ $I_C=2mA,$	---	2	18	μs
	Descend Time	t_f	$R_L=100\Omega,$ $f=100Hz$	---	3	18	μs

- Current Conversion Ratio = $I_C / I_F \times 100\%$

6. Rank table of current transfer ratio CTR

MODEL NO.	CTR Rank	Min.	Max.	Condition	Unit
OR-3H7	A	80	160	IF=5mA, V _{CE} =5V, Ta=25°C	%
	A1	100	160		
	B	130	260		
	C	200	400		
	D	300	600		
	No Mark	50	600		
	AL	100	200	IF=0.5mA, V _{CE} =5V, Ta=25°C	
	BLL	200	400		
	GB	100	600	IF=5mA, V _{CE} =5V, Ta=25°C	
				IF=0.5mA, V _{CE} =5V, Ta=25°C	

- Current Conversion Ratio = $I_C / I_F \times 100\%$

7. Order Information

Part Number

OR-3H7X-W-Y-Z

Note

X = CTR Rank (A, A1, B, C, D, AL, BLL, GB or none)
W = Tape and reel option (TP or TP1).
Y = 'V' code for VDE safety (This options is not necessary).
Z = 'G' code for Halogen free.

* VDE Code can be selected.

Option	Description	Packing quantity
TP	Surface mount lead form (low profile) + TP tape & reel option	3000 units per reel
TP1	Surface mount lead form (low profile) + TP1 tape & reel option	3000 units per reel

8. Naming Rule

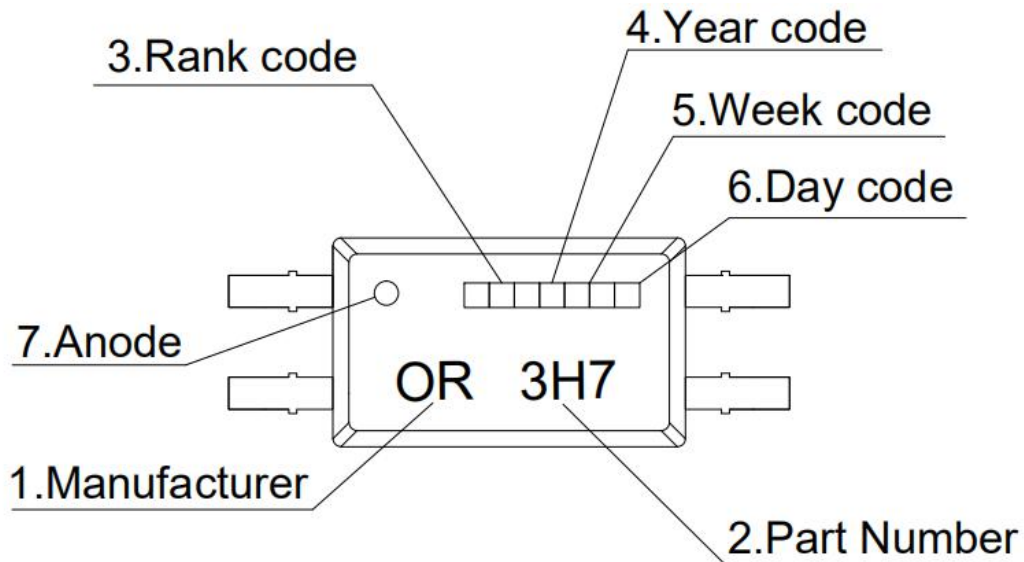

(1) ORIENT.

(2) 3H7 denotes Device Part Number.

(3) denotes Rank Code.

(4) denotes Year Code.

(5) denotes Week Code.

(6) denotes Day Code.

(7) Anode.

* Halogen Free Mark can be selected.

* VDE Mark can be selected.

9. Outer Dimension

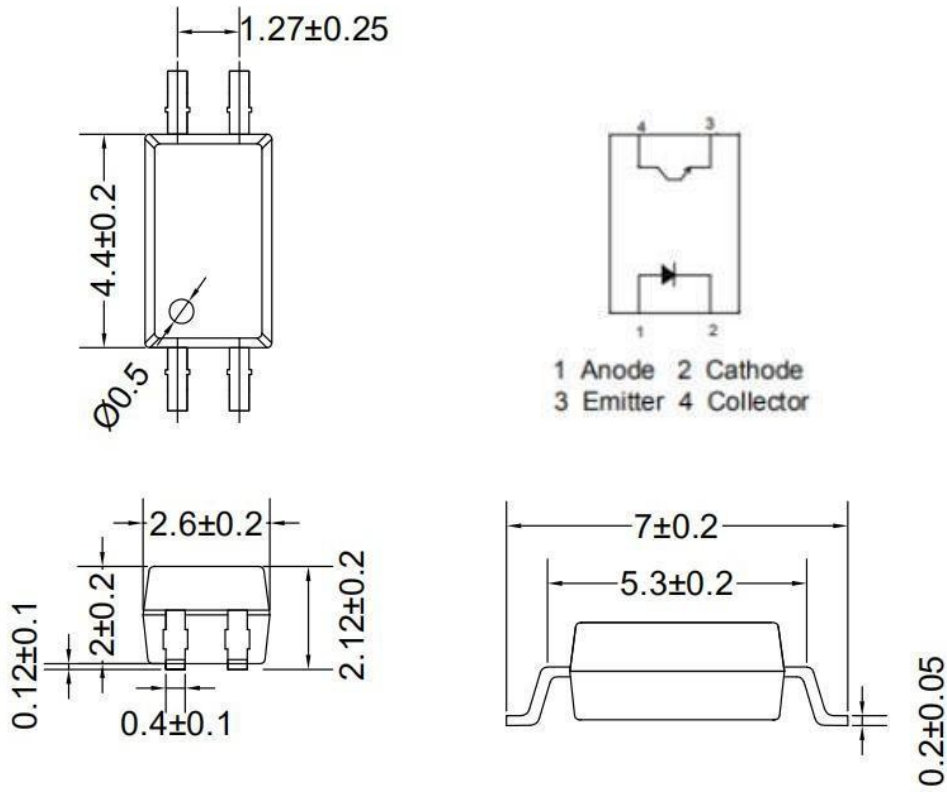

10. Recommended Foot Print Patterns (Mount Pad) (Unit:mm)

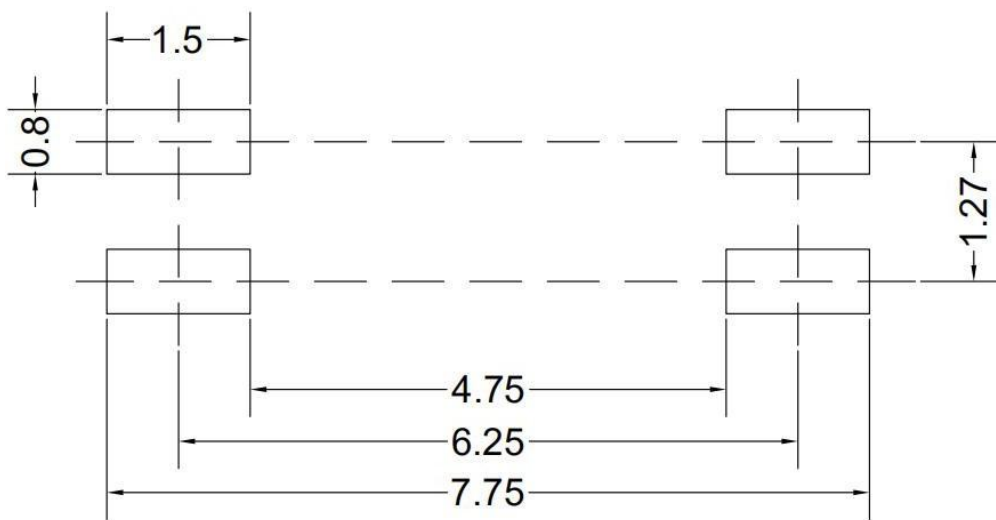

11. Taping Dimensions

(1)OR-3H7-TP

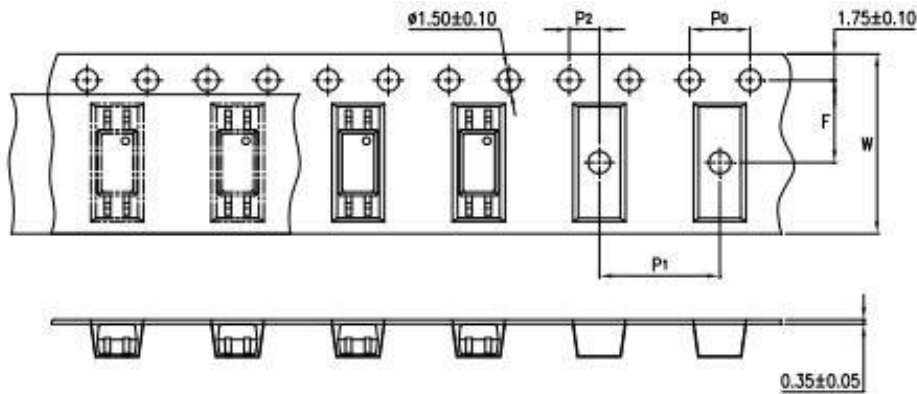

(2)OR-3H7-TP1

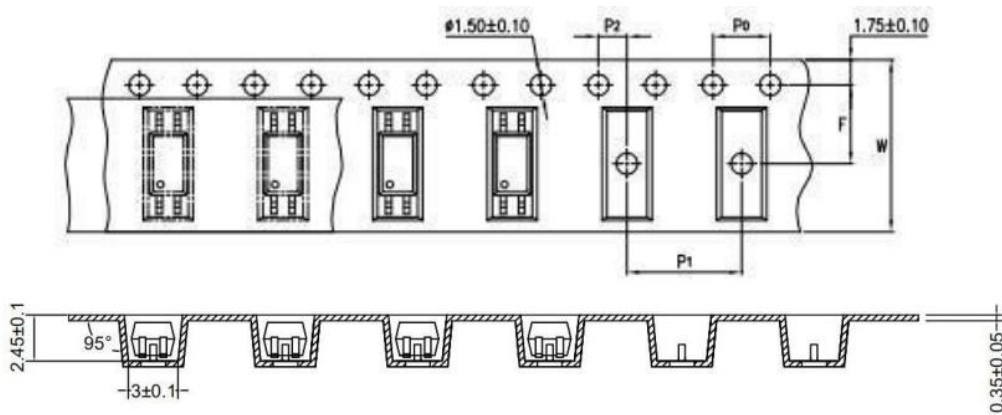

type	Symbol	Dimensions: mm (in.)
bandwidth	W	12±0.3 (0.47)
pitch	P0	4±0.1 (0.15)
pitch	F	5.5±0.1 (0.217)
	P2	2±0.1 (0.079)
interval	P1	8±0.1 (0.315)

Encapsulation type	TP/TP1
Quantity (pieces)	3000

12. Package Dimension

(1) package dimension

Packing Information

Packing Information	
Packing type	Reel type
Tape Width	12mm
Qty per Reel	3,000
Small box (inner) Dimension	345*345*45mm
Max qty per small box	6,000
Large box (Outer) Dimension	480x360x360mm
Max qty per large box	60,000

(2) Packing Label Sample



1. MTL NO: Contents with "Order Information" in the specification.
2. LOT NO: The production cycle of the product.
3. BATCH: The CTR RANK of the product.
4. Quantity: Product packaging quantity.
5. Product Data: The data when product be made.

13. Reliability Test

NO.	Item	Condition	Quantity	Cycle	Reference Standards
1	RSH, Resistance to Solder Heat	260±5°C,20s/cycle	22	3 cycles	JESC22A-106
2	SD, Solderability	260±5°C, 10s/cycle	22	1 cycle	JESD22-B102
3	TC, Temperature Cycle	H: 125°C 15min ∫ 5min L: -55°C 15min	77	300cycles	JESC22A-104
4	TS, Thermal Shock	H:100°C 5min ∫ 15s L:-10°C 5min	77	300cysles	JESC22A-106
5	LTSL, Low Temperature Storage	T:-55°C	77	1000h	JESD22-A119
6	HTSL, High Temperature Storage	T:125°C	77	1000h	JESC22A-103
7	THB, High Temperature High Humidity	T:85°C RH: 85%	77	1000h	JESC22A-101
8	HTOL DC Operating Life	T: 110°C IF=10mA VCC=5V	77	1000h	MIL-STD-750 Method 1037
9	ESD-HBM Human Body Model ESD	Ta=25° C, Reference JESD22-A114	6	1 cycle	JESD22-A114

14. Temperature Profile Of Soldering

(1) IR Reflow soldering (JEDEC-STD-020C compliant)

One time soldering reflow is recommended within the condition of temperature and time profile shown below. Do not solder more than three times.

Profile item	Conditions
Preheat - Temperature Min (T Smin) - Temperature Max (T Smax) - Time (min to max) (ts)	150°C 200°C 90±30 sec
Soldering zone - Temperature (TL) - Time (t L)	217°C 60 sec
Peak Temperature	260°C
Peak Temperature time	20 sec
Ramp-up rate	3°C / sec max.
Ramp-down rate from peak temperature	3~6°C / sec
Reflow times	≤3

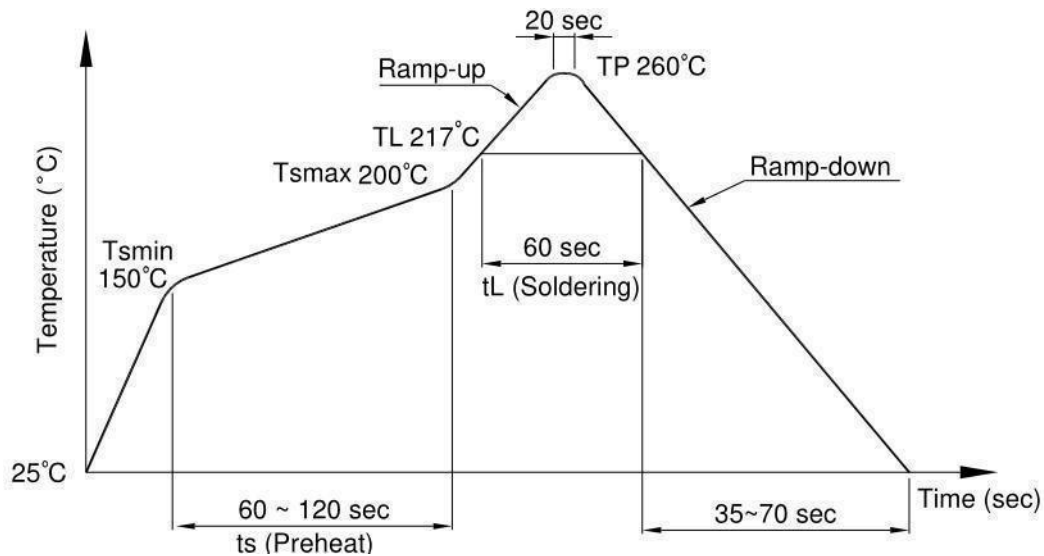

(2).Wave soldering (JEDEC22A111 compliant)

One time soldering is recommended within the condition of temperature.

Temperature	260+0/-5°C
Time	10 sec
Preheat temperature	25 to 140°C
Preheat time	30 to 80 sec

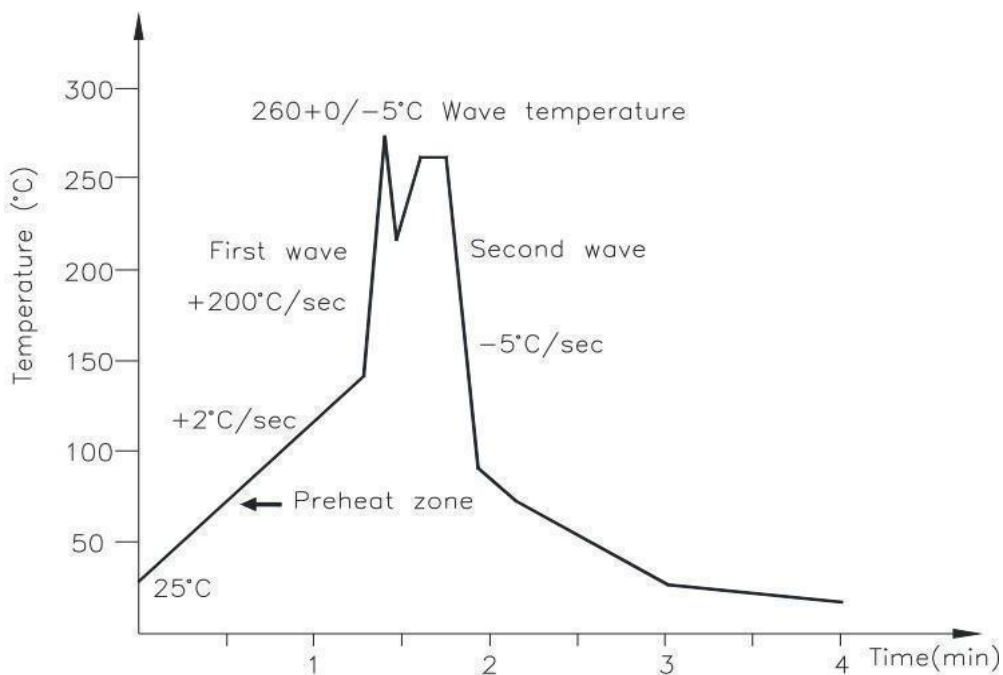

(3).Hand soldering by soldering iron

Allow single lead soldering in every single process. One time soldering is recommended.

Temperature	380+0/-5°C
Time	3 sec max

15. Characteristics Curve

Figure 1. Collector Power Dissipation vs. Ambient Temperature

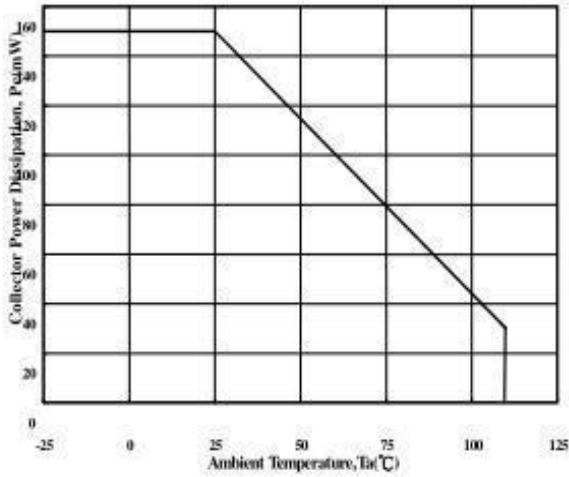

Figure 2. Forward Current vs. Ambient Temperature

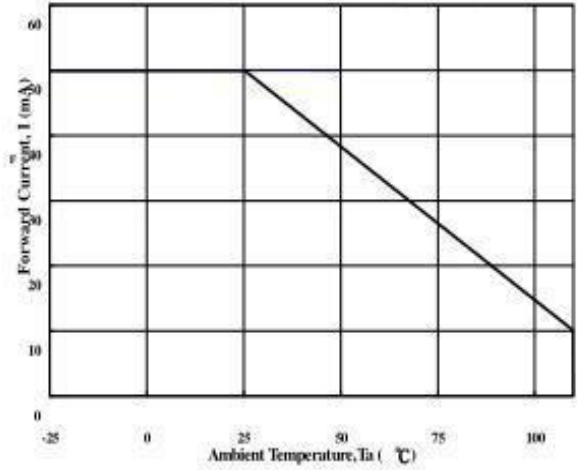

Figure 3. Forward Current vs. Forward Voltage

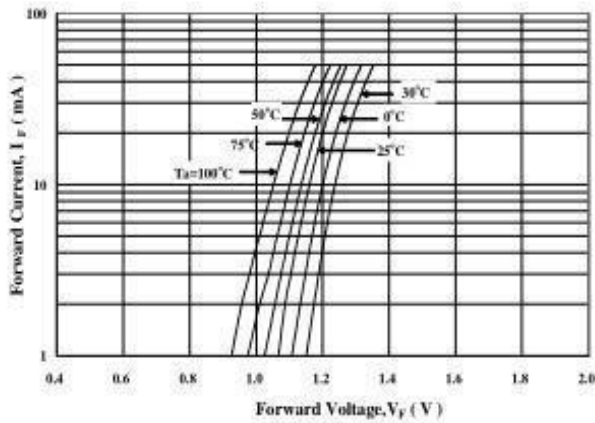

Figure 4. Forward Voltage Temperature Coefficient vs. Forward Current

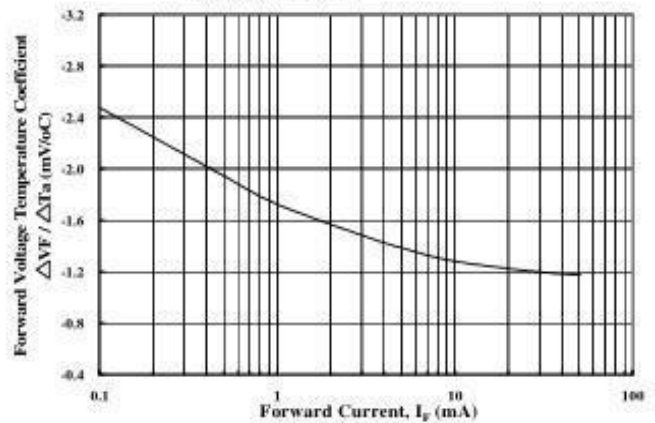

Figure 5. Pulse Forward Current vs. Duty Cycle Ratio

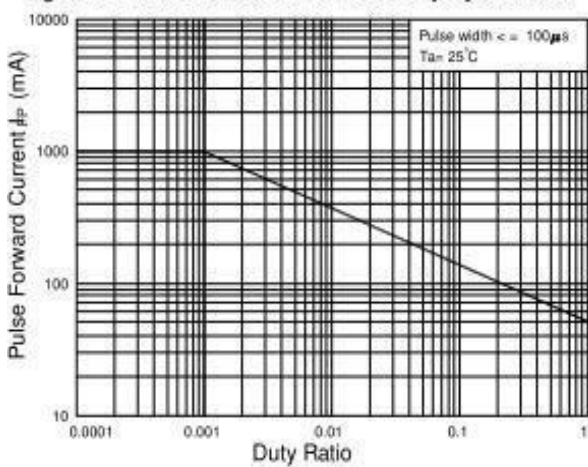

Figure 6. Pulse Forward Current vs. Pulse Forward

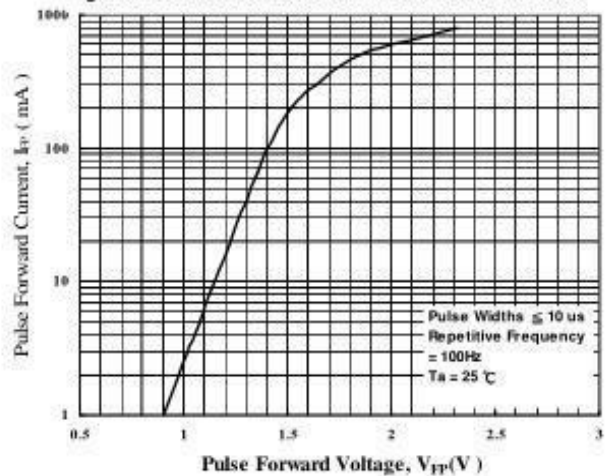

Figure 7. Collector-Emitter Saturation Voltage vs. Forward

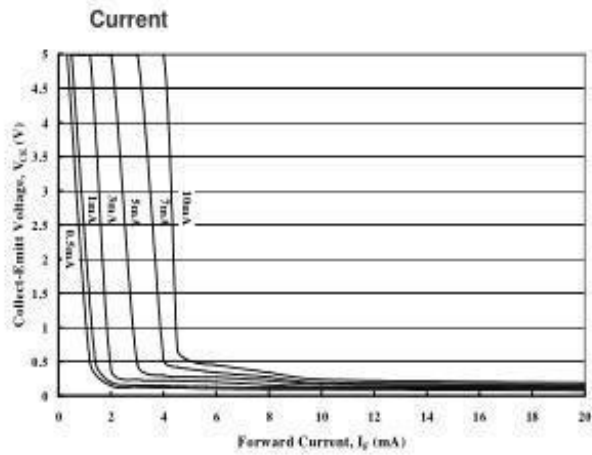

Figure 8. Collector Current vs. Collector-Emitter

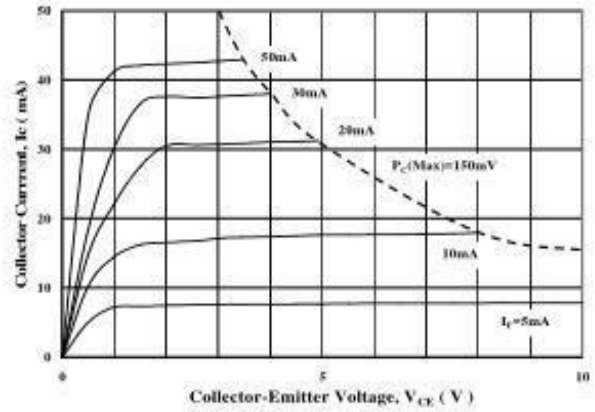

Figure 9. Collector Current vs. Small Collector-Emitter

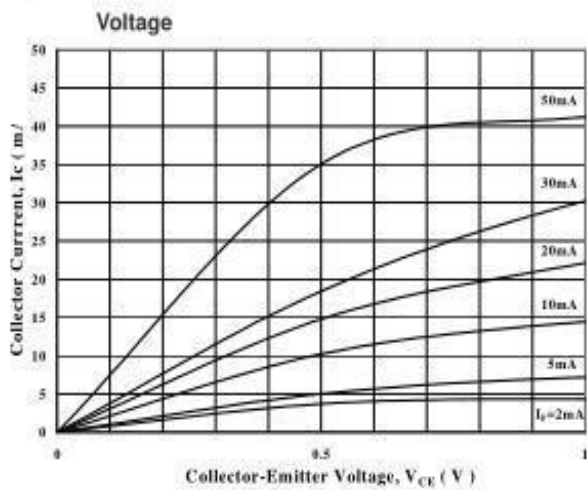

Figure 10. Normalized CTR vs. Forward Current

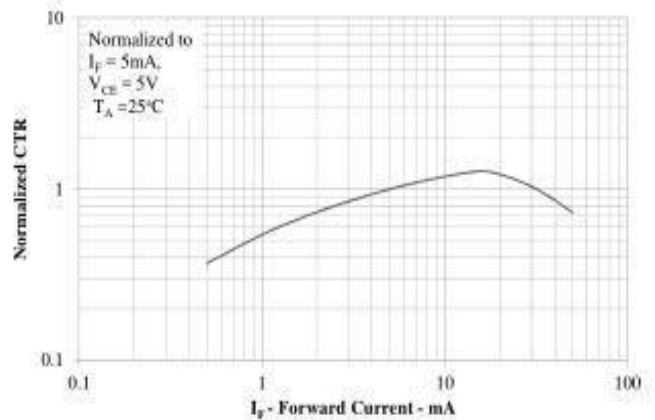

Figure 11. Collector Dark Current vs. Ambient Temperature

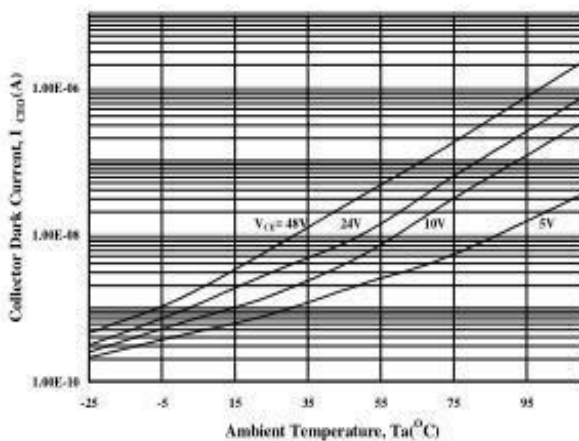

Figure 12. Current Transfer Ratio vs. Forward

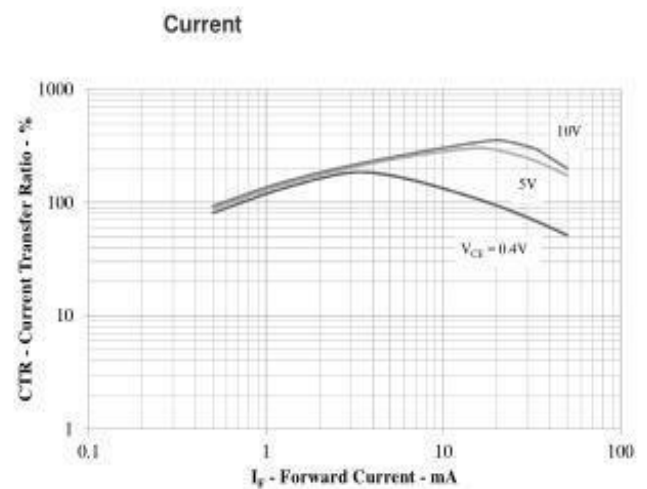

Figure 13. Normalized CTR vs. Ambient Temperature

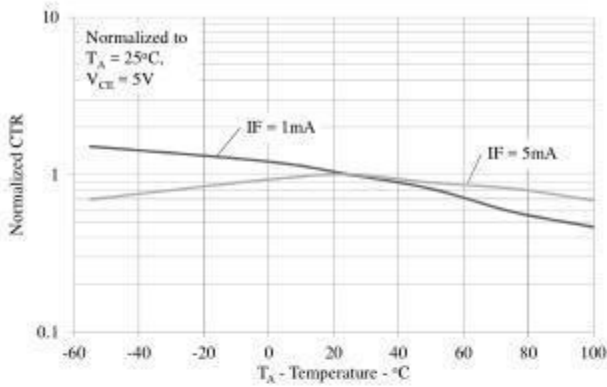

Figure 14. Collector-Emitter Saturation Voltage vs. Ambient Temperature

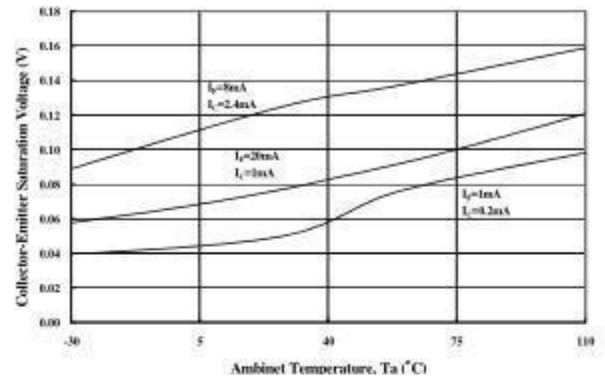

Figure 15. Collector Current vs. Ambient Temperature

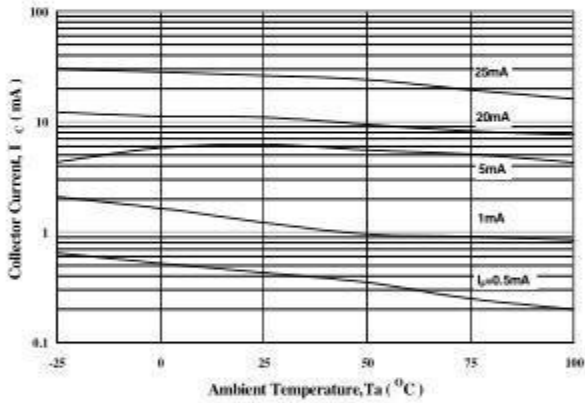

Figure 16. Switching Time vs. Load Resistance

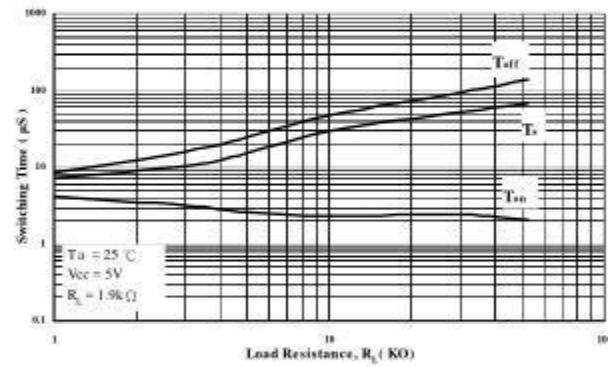

Figure 17. Switching Time vs. Ambient Temperature

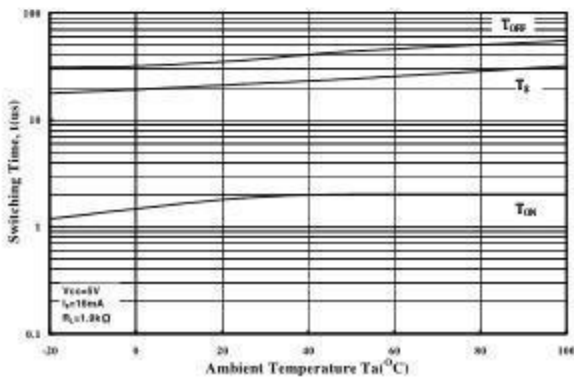
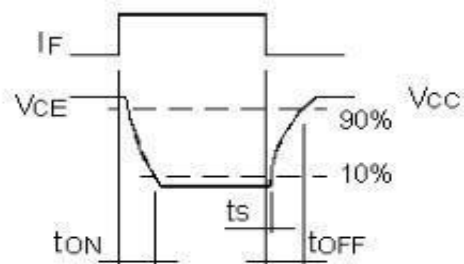
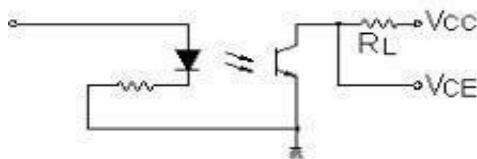
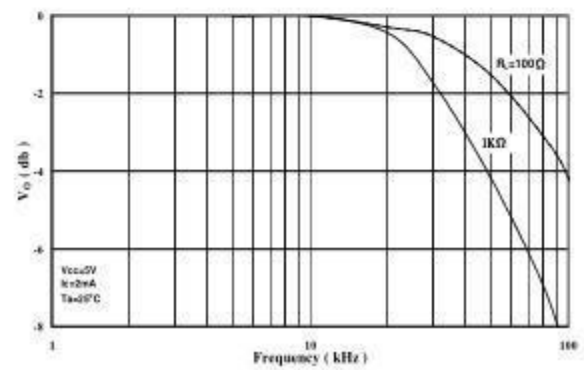

Figure 18. Frequency Response



X-ON Electronics

Largest Supplier of Electrical and Electronic Components

Click to view similar products for [Photodiode Output Optocouplers](#) category:

Click to view products by [Orient](#) manufacturer:

Other Similar products are found below :

[TLP590B\(C,F\)](#) [TLP5214\(D4.E\(O](#) [TLP7820\(A-LF4.E\(O](#) [IS281](#) [APV2111V](#) [APV1121SX](#) [APV2111VY](#) [TLP190B\(TPR,U,C,F\)](#)
[TLP3906\(TPL,E](#) [TLP591B\(C,F\)](#) [TLP3905\(E](#) [IS281GR](#) [APS1241S](#) [APS2241S](#) [APV1122AJ](#) [APV1122J](#) [APV2121SJ](#) [TLP191B\(U.C.F\)](#)
[APV2121S](#) [TLP3906\(TPR,E\(O](#) [TLP3914\(TP15,F\)](#) [APV1121SJ](#) [NSL 32](#) [NSL-32SR3](#) [AQW214E2HAXL1](#) [QCPL-329J-500E](#) [TLP521-](#)
[2XGBSMT&R](#) [TLP521-2SMT&R](#) [K20102B TLD](#) [KPS28320E TLD](#) [CTH214A\(T1\)](#) [CT354\(V\)\(T1\)](#) [LTV-214-TP1-GR-G](#) [CTH217C\(V\)\(T1\)](#)
[CYMOC3023S\(TP1\)](#) [CYMOC3041S\(TP1\)](#) [CYMOC3061S\(TP1\)](#) [CYMOC3083S\(TP1\)](#) [CYPC356\(C-TP\)](#) [CYPS2501-1\(L-TP2\)](#)
[CYTLP127\(TP\)](#) [CYTLP291\(GB-TP\)](#) [KP10400E](#) [817B](#) [EL817M\(C\)-F](#) [K10103C](#) [KP40101C](#) [K30101A](#) [K30101C](#) [GX817MC](#)