



# ORIENT

## Photo MOS

### Product Data Sheet

Part Number: OR-4XXA

Customer: \_\_\_\_\_

Date: \_\_\_\_\_

**SHENZHEN ORIENT COMPONENTS CO., LTD**

Block A3rd Floor No.4 Building, Tian'an Cyber Park, Huangge Rd, LongGang Dist, Shenzhen, GD

TEL: 0755-29681817

FAX: 0755-29681200

[www.orient-opto.com](http://www.orient-opto.com)

**1. Features**

- (1) High input-output isolation voltage (  $V_{iso} = 5,000V_{rms}$  )
- (2) Normally open signal pole signal throw relay
- (3) Low operating current
- (4) 60 to 600V output withstand voltage
- (5) Low on resistance
- (6) In compliance with RoHS, REACH standards
- (7) MSL Class I
- (8) Safety approval

UL approved (No.E323844)  
 VDE approved(No.40029733)  
 CQC approved (No.CQC09001029446)



**2. Description**

- (1) The OR-406A, OR-425A, OR-440A and OR-460A are solid state relays containing an AlGaAs infrared LEDs on the light emitting side (input side) optically coupled to a high voltage output detector circuit. The detector consists of a photo voltaic diode array and MOSFETs on the output side. The single channel configuration is equivalent to 1 form AEMR.
- (2) They are packaged in a 4-pin DIP package and available in wide-lead spacing and SMD option.

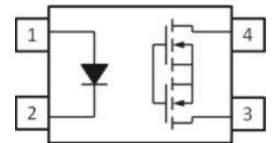

**Pin Configuration**  
 1. Anode  
 2. Cathode  
 3. 4. MOSFET

**3. Applications**

- (1)Exchange equipment      (2)Measurement equipment      (3)FA/OA equipment
- (4)Industrial controls      (5)Security

**4. Absolute Maximum Ratings at Ta=25°C**

Parameter	Symbol	Rating				Unit	
		OR406A	OR425A	OR440A	OR460A		
Input	Forward Current	$I_F$	50				mA
	Reverse Voltage	$V_R$	5				V
	Peak Forward Current*1	$I_{FP}$	1				A
	Power Dissipation	$P_{in}$	75				mW
Output	Break Down Voltage	$V_L$	60	250	400	600	V
	Continuous Load Current	$I_L$	550	150	120	50	mA
	Pulse Load Current*2	$I_{LPeak}$	1.2	0.5	0.3	0.15	A
	Power Dissipation	$P_{out}$	500				mW
Total Power Dissipation		$P_T$	550				mW
Isolation Voltage*3		$V_{iso}$	5000				Vrms
Storage Temperature		$T_{STG}$	-40 to 125				°C
Operating Temperature		$T_{OPR}$	-40 to 85				°C
Soldering Temperature*4		$T_{SOL}$	260				°C

Notes:

- \*1.  $f = 100Hz$ , Duty Cycle = 0.1%
- \*2. A connection: 100ms (1 shot),  $V_L = DC$
- \*3. AC for 1 minute, R.H. = 40 ~ 60% R.H. In this test, pins 1, 2 are shorted together, and pins 3, 4 are shorted together.
- \*4. For 10 seconds

**5. Electro-Optical Characteristics (Ta=25°C unless specified otherwise)**

Parameter		Symbol	Min.	Typ.	Max.	Unit	Condition	
Input	Forward Voltage	$V_F$	---	1.18	1.5	V	$I_F = 10\text{mA}$	
	Reverse Current	$I_R$	---	---	1	$\mu\text{A}$	$V_R = 5\text{V}$	
Output	Off State leakage Current		$I_{\text{leak}}$	---	---	1	$\mu\text{A}$	$I_F = 0\text{mA}, V_L = \text{Max.}$
	On Resistance	OR-406A	$R_d(\text{ON})$	---	0.7	2.5	$\Omega$	$I_F = 10\text{mA},$ $I_L = \text{Max.},$ $t = 1\text{s}$
		OR-425A		---	6.5	15		
		OR-440A		---	20	30		
		OR-460A		---	40	70		
	Output Capacitance	OR-406A	$C(\text{out})$	---	85	---	$\text{pF}$	$V_L = 0\text{V}, f = 1\text{MHz}$
		OR-425A		---	60	---		
		OR-440A		---	45	---		
OR-460A		---		30	---			
Transfer Characteristics	LED turn on Current	OR-406A	$I_F(\text{on})$	---	1	3	$\text{mA}$	$I_L = \text{Max.}$
		OR-425A		---	1.1	3		
		OR-440A		---	1.25	3		
		OR-460A		---	0.9	3		
	LED turn off Current	OR-406A	$I_F(\text{off})$	0.4	0.9	---	$\text{mA}$	$I_L = \text{Max.}$
		OR-425A		0.4	1.0	---		
		OR-440A		0.4	1.15	---		
		OR-460A		0.4	0.8	---		
	Turn On Time	OR-406A	$T_{\text{on}}$	---	0.25	1	$\text{ms}$	$I_F = 10\text{mA},$ $I_L = \text{Max.},$ $R_L = 200\Omega$
		OR-425A		---	0.25	1		
		OR-440A		---	0.25	1		
		OR-460A		---	0.25	1		
	Turn Off Time	OR-406A	$T_{\text{off}}$	---	0.05	0.5	$\text{ms}$	$I_F = 10\text{mA},$ $I_L = \text{Max.},$ $R_L = 200\Omega$
		OR-425A		---	0.05	0.5		
		OR-440A		---	0.05	0.5		
		OR-460A		---	0.05	0.5		
Isolation Resistance		$R_{\text{I-O}}$	$5 \times 10^{10}$	$1 \times 10^{12}$	---	$\Omega$	$V_{\text{I-O}} = 500\text{V DC}$	
Isolation Capacitance		$C_{\text{I-O}}$	---	1.5	---	$\text{pF}$	$V = 0\text{V}, f = 1\text{MHz}$	



## 6. Order Information

### Part Number

# OR-4XXAU-W-Y-Z

### Note

4XXA = Part Number (XX for 06, 25, 40 or 60)

U = Lead form option (S, M or none)

W = Tape and reel option ( TP,TP1 or none).

Y = 'V' code for VDE safety (This options is not necessary).

Z = 'G' code for Halogen free.

\* VDE Code can be selected.

Option	Description	Packing quantity
None	Standard DIP-4	100 units per tube
M	Wide lead bend (0.4 inch spacing)	100 units per tube
S(TP)	Surface mount lead form (low profile) + TP tape & reel option	2000 units per reel
S(TP1)	Surface mount lead form (low profile) + TP1 tape & reel option	2000 units per reel

## 7.Naming Rule

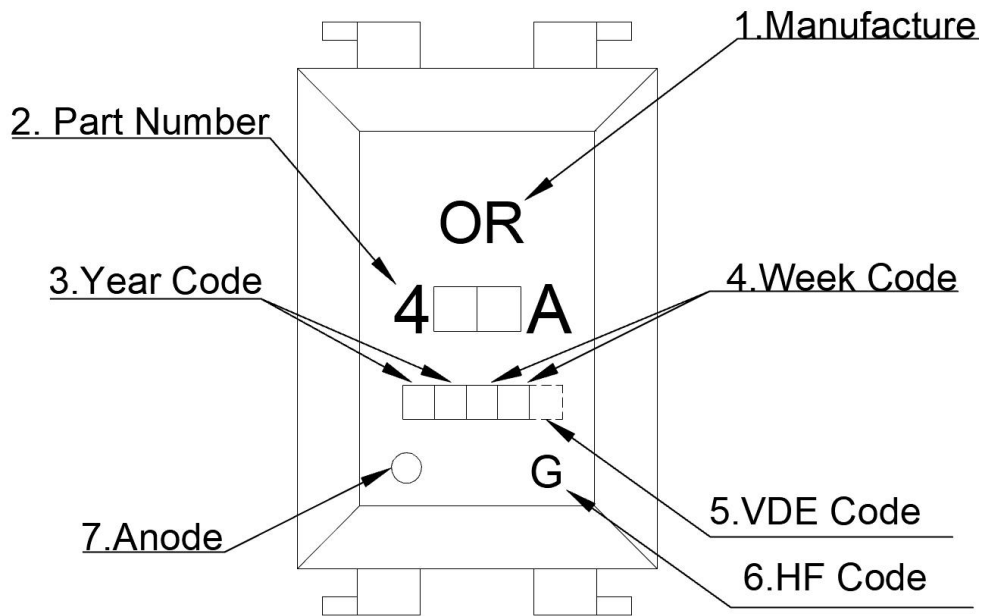

1. Manufacturer : ORIENT.
2. Part Number : 406A, 425A, 440A or 460A.
3. Year Code   : '21' means '2021' and so on.
4. Week Code  : 01 represents the first week, 02 represents the second week, and so on.
5. VDE Code   . (Optional)
6. Halogen free.
7. Anode.

8. Package Dimension (Unit: mm)

(1) OR-4XXA

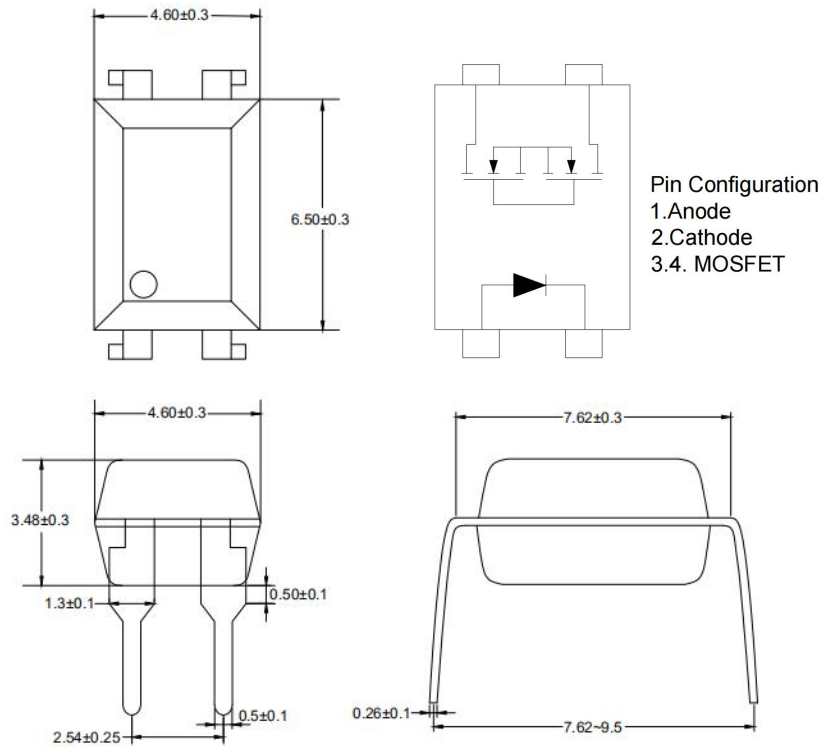

(2) OR-4XXAM

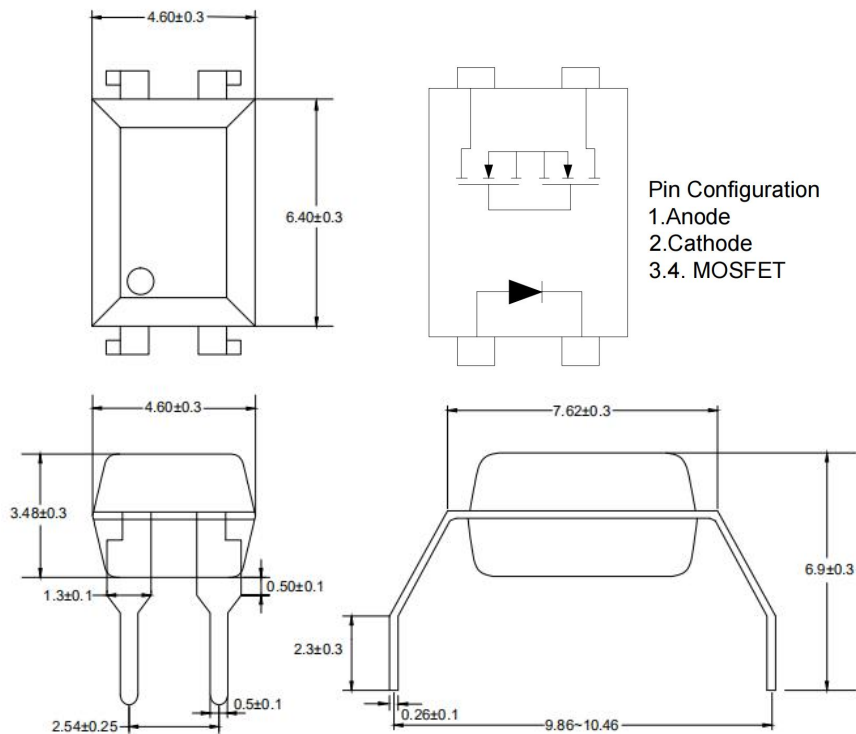

**(3) OR-4XXAS**

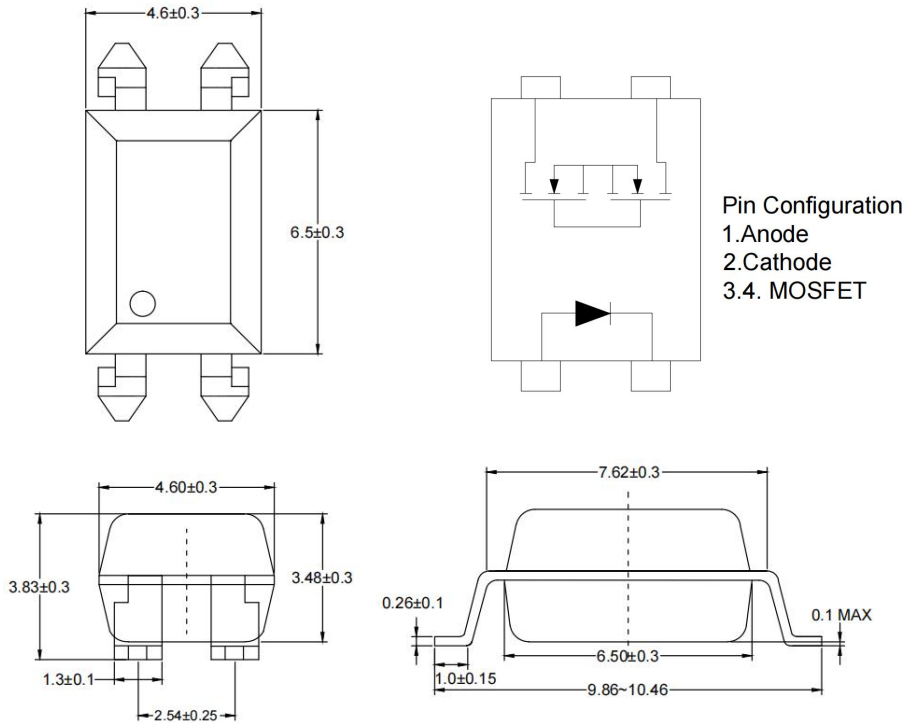

**9. Taping Dimensions**

**(1)OR-4XXAS-TP**

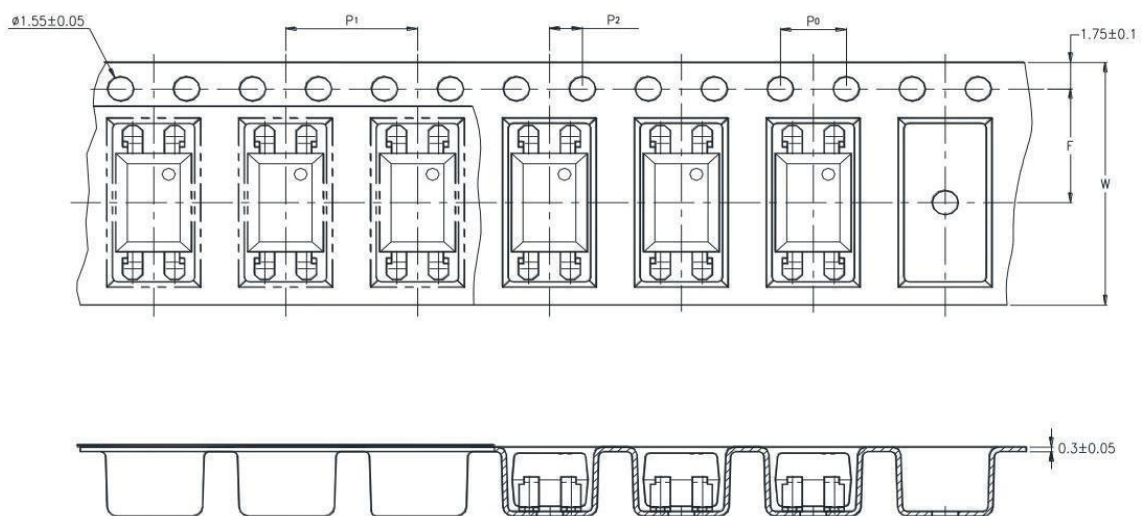

(2)OR-4XXAS-TP1

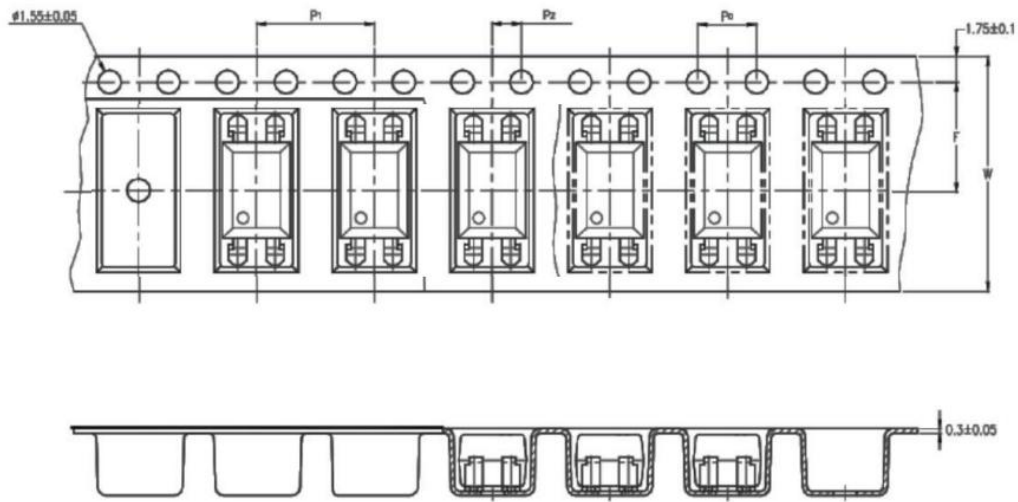

Description	Symbol	Dimension in mm (inch)
Tape wide	W	16±0.3 (.63)
Pitch of sprocket holes	$P_0$	4±0.1 (.15)
Distance of compartment	F	7.5±0.1 (.295)
	$P_2$	2±0.1 (.0079)
Distance of compartment to compartment	$P_1$	8±0.1 (.472)

Package Type	TP/TP1
Quantities(pcs)	2000

10. Recommended Foot Print Patterns (Mount Pad) (Unit: mm)

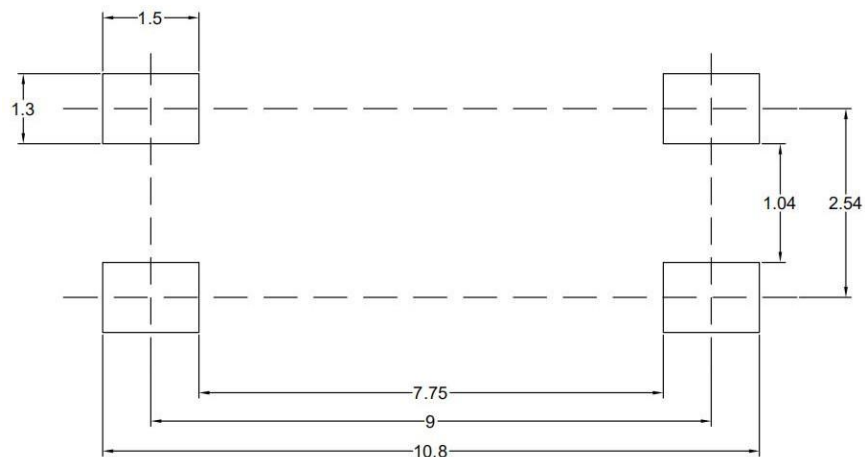



## 11. Package Dimension

### (1) package dimension

DIP/M type

Packing Information	
Packing type	Tube
Qty per Tube	100pcs
Small box (Inner) Dimension	525*128*60mm
Large box (Outer) Dimension	545*290*335mm
The Amount per Inner Box	5,000pcs
The Amount per Outer Box	50,000pcs

SOP type

Packing Information	
Packing type	Reel type
Tape Width	16mm
Qty per Reel	2,000pcs
Small box (inner) Dimension	345*345*58.5mm
Large box (Outer) Dimension	620x360x360mm
Max qty per small box	4,000pcs
Max qty per large box	40,000pcs

### (2)Packing Label Sample



The label sample includes the following elements:

- Logos:** ORIENT (ShenZhen Orient Components Co.,LTD), DVE, UL, RoHS REACH.
- Material Code:** 120PCXXXXXX
- P/N:** OR-XXXXXX
- Lot No.:** XXXXXX-XXXX-TX-X
- D/C:** XXXX
- Qty:** XXXX PCS
- Inner Box Code:** 内箱码
- Outer Box Code:** 外箱码
- Serial Code:** "XXXXXXXXXXXXXXXX" (一体机序列码)
- Origin:** Made in China

#### Note:

1. Material Code :Product ID.
2. P/N :Contents with "Order Information" in the specification.
3. Lot No. :Product data.
4. D/C :Product weeks.
5. Quantity :Packaging quantity.

## 12. Temperature Profile Of Soldering

### (1).IR Reflow soldering (JEDEC-STD-020C compliant)

One time soldering reflow is recommended within the condition of temperature and time profile shown below. Do not solder more than three times.

Profile item	Conditions
Preheat - Temperature Min (T Smin ) - Temperature Max (T Smax ) - Time (min to max) (ts)	150°C 200°C 90±30 sec
Soldering zone - Temperature (TL ) - Time (t L )	217°C 60 sec
Peak Temperature	260°C
Peak Temperature time	20 sec
Ramp-up rate	3°C / sec max.
Ramp-down rate from peak temperature	3~6°C / sec
Reflow times	≤3

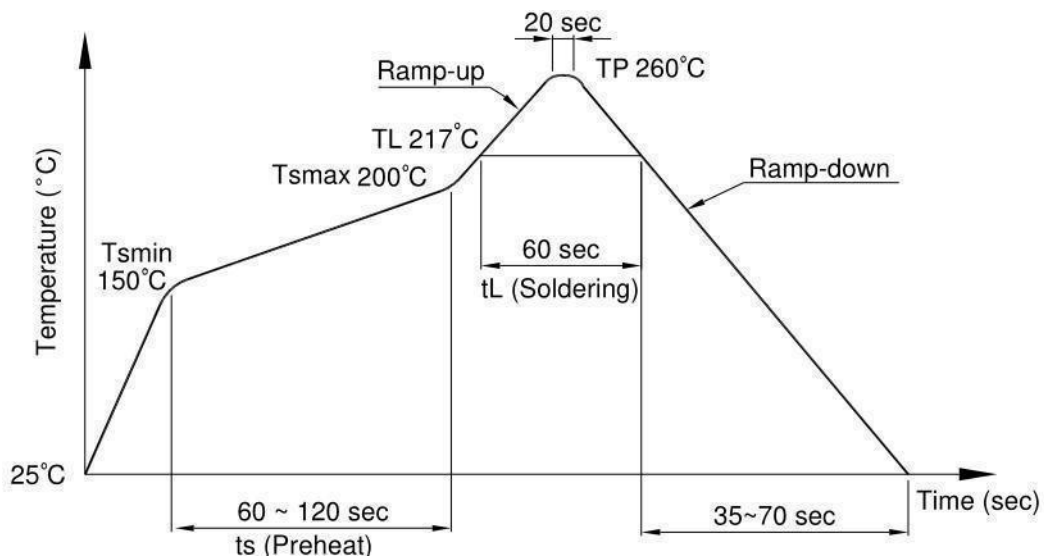

**(2).Wave soldering (JEDEC22A111 compliant)**

One time soldering is recommended within the condition of temperature.

Temperature	260+0/-5°C
Time	10 sec
Preheat temperature	25 to 140°C
Preheat time	30 to 80 sec

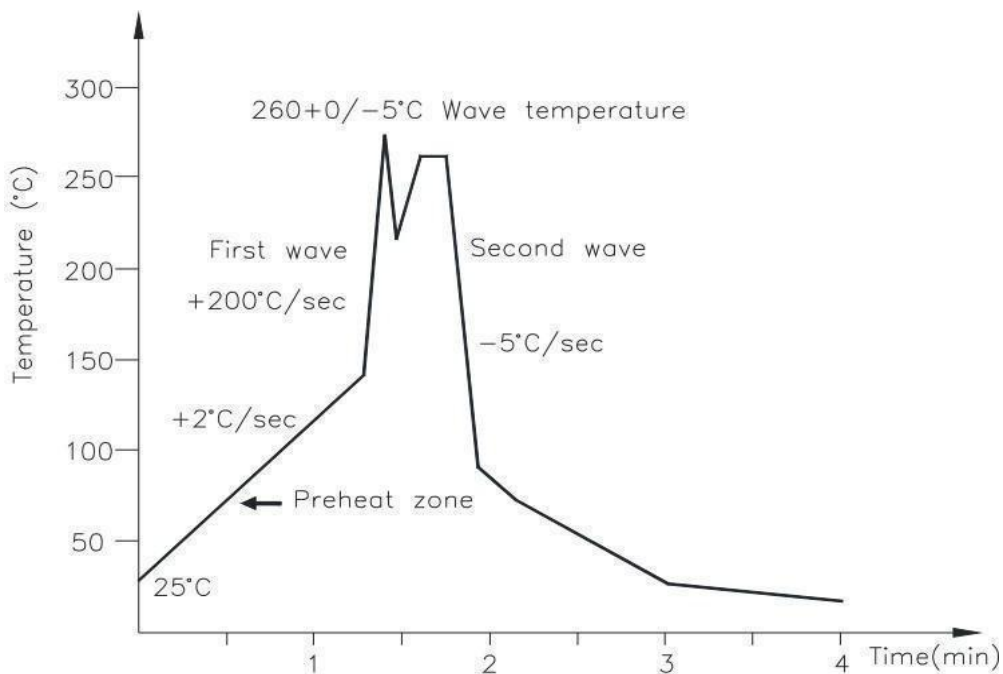

**(3).Hand soldering by soldering iron**

Allow single lead soldering in every single process. One time soldering is recommended.

Temperature	380+0/-5°C
Time	3 sec max

### 13. Characteristics Curves

Figure 1-1. Load current vs Ambient temperature

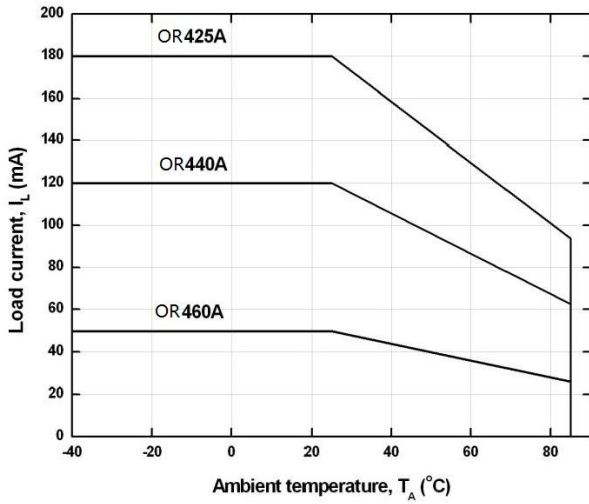

Figure 1-2. Load current vs Ambient temperature

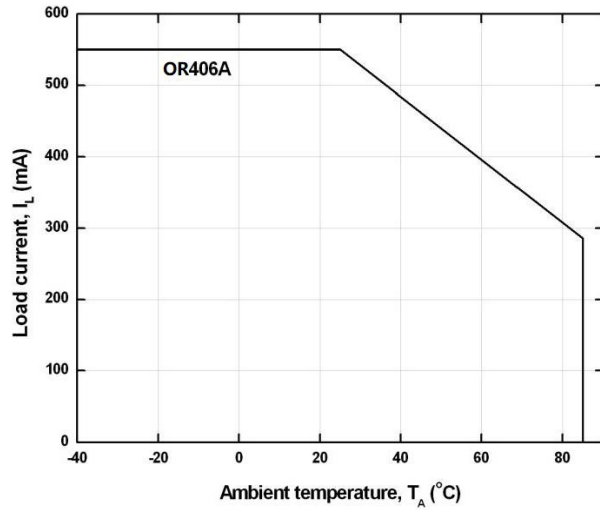

Figure 2-1. On Resistance vs Ambient Temperature

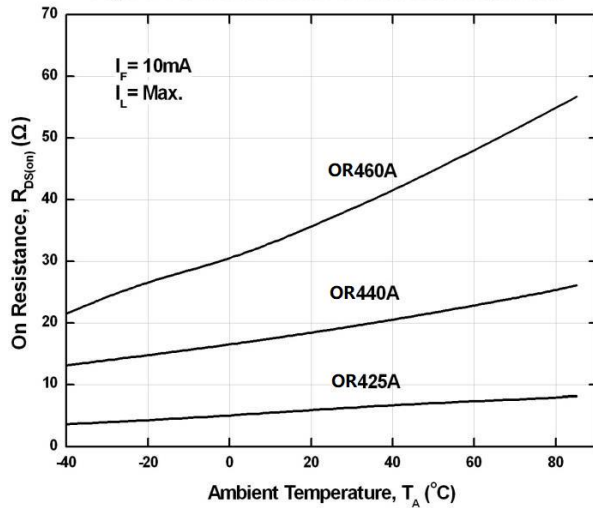

Figure 2-2. On Resistance vs Ambient Temperature

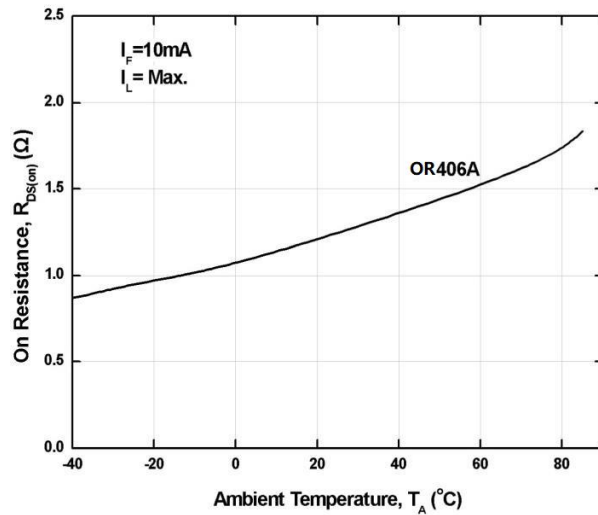

Figure 3. Switching Time vs Ambient Temperature

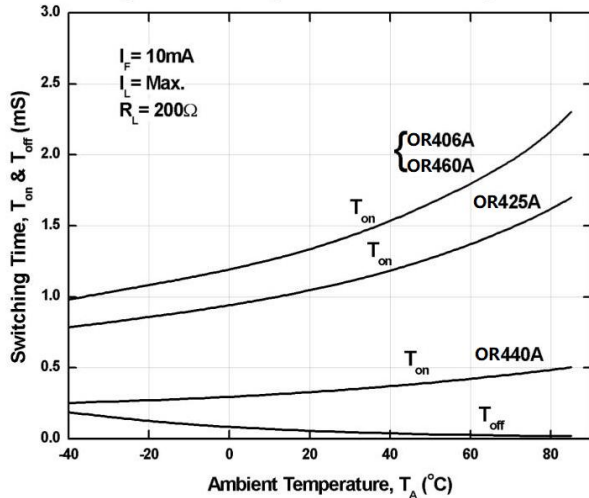

Figure 4-1. Turn On Time vs LED Forward Current

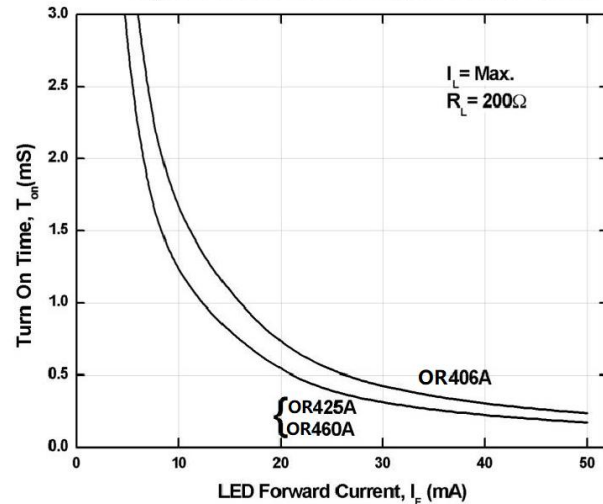

Figure 4-2. Turn On Time vs LED Forward Current

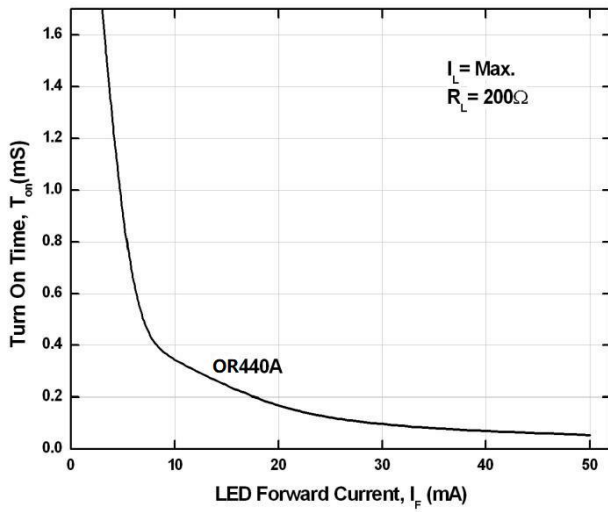

Figure 5. Turn Off Time vs LED Forward Current

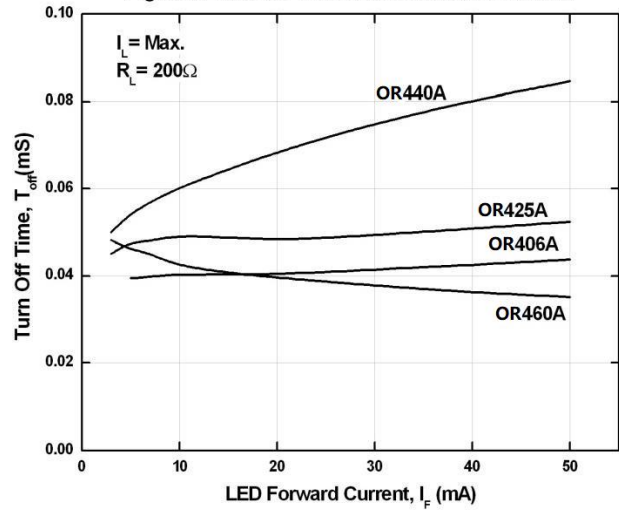

Figure 6. Normalized LED Operate on Current vs Ambient Temperature

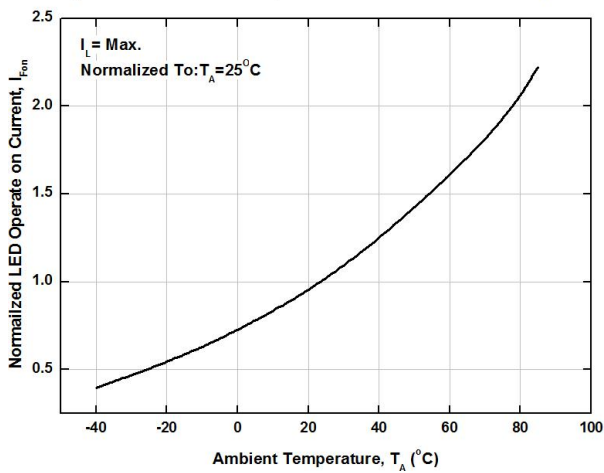

Figure 7. Normalized LED Turn off Current vs Ambient Temperature

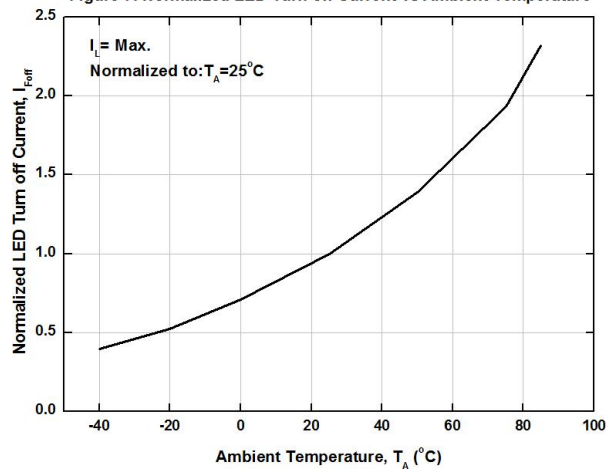

Figure 8. LED Dropout Voltage vs Ambient Temperature

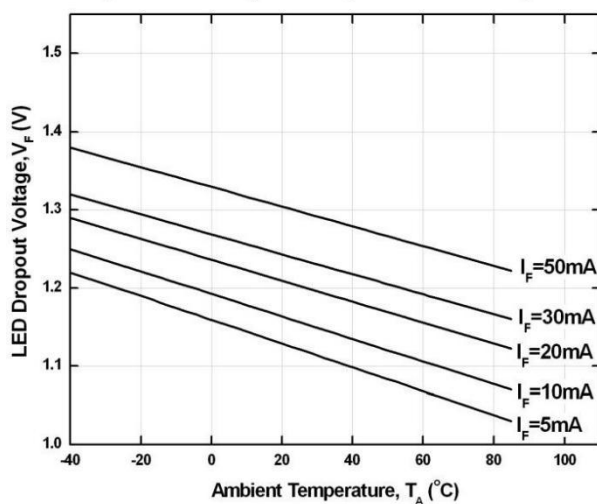

Figure 9-1. Load Voltage vs Load Current

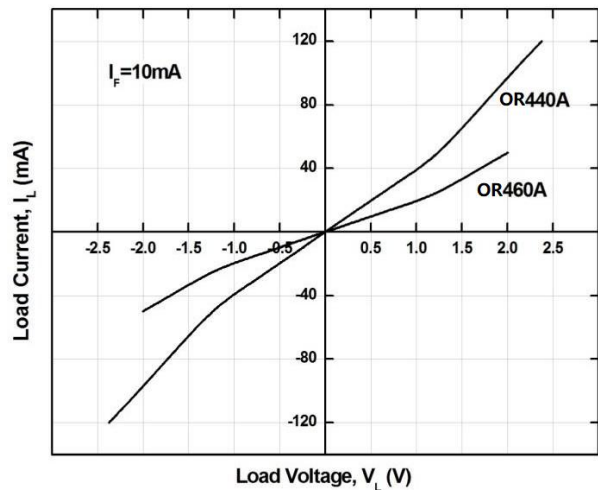

Figure 9-2. Load Voltage vs Load Current

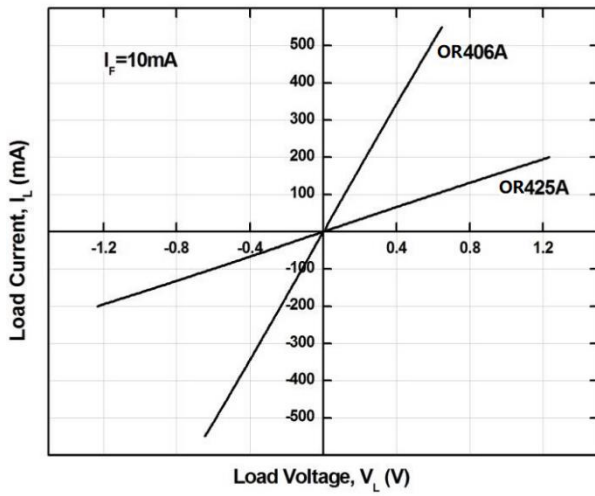

Figure 10. Off State Leakage Current vs Load Voltage

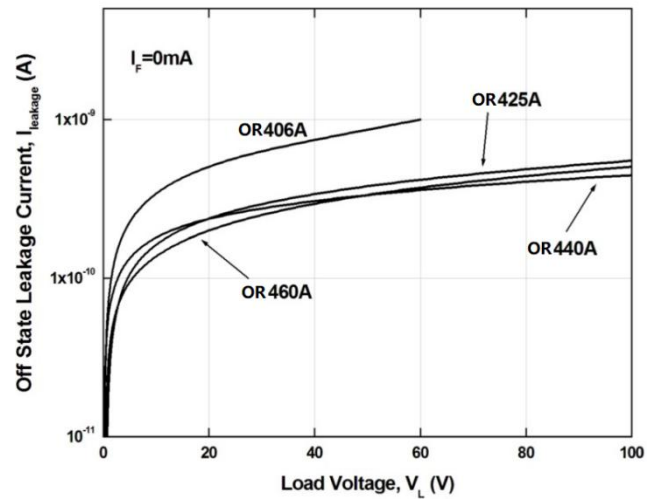
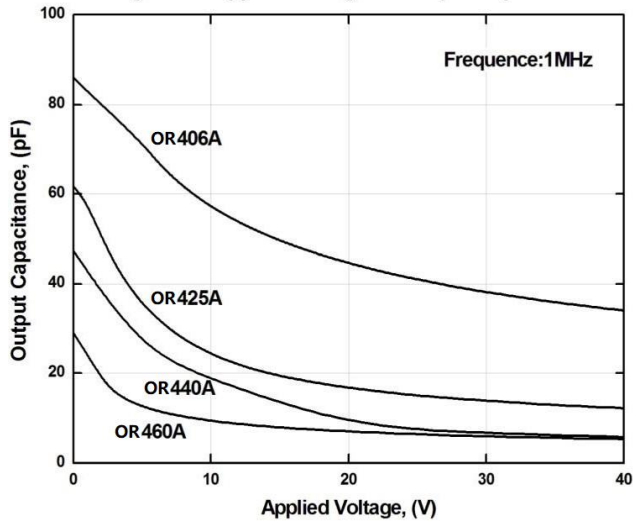

Figure 11. Applied Voltage VS Output Capacitance



## X-ON Electronics

Largest Supplier of Electrical and Electronic Components

*Click to view similar products for [Solid State Relays - PCB Mount](#) category:*

*Click to view products by [Orient](#) manufacturer:*

Other Similar products are found below :

[M86F-2W](#) [M90F-2W](#) [M90F-2Y](#) [901-SX](#) [G2-1A07-ST](#) [G2-1A07-TT](#) [G2-1B02-TT](#) [G2-DA06-ST](#) [PLA134S](#) [DS11-1005](#) [AQH3213J](#)  
[AQV210EHJ](#) [AQV212J](#) [AQV252GAJ](#) [AQV258AJ](#) [AQY210ST](#) [AQY221N2SJ](#) [AQY221R2SJ](#) [EFR1200480A150](#) [901-7](#) [LCA220](#) [LCB110S](#)  
[1618400-5](#) [SR75-1ST](#) [AQV112KLJ](#) [AQV212AJ](#) [AQV238AD01](#) [AQV252GAXJ](#) [AQW414TS](#) [AQY212ST](#) [AQY275AXJ](#) [AQY414SXE01](#)  
[G2-1A02-ST](#) [G2-1A03-ST](#) [G2-1A03-TT](#) [G2-1A05-ST](#) [G2-1A06-TT](#) [G2-1A23-TT](#) [G2-1B01-ST](#) [G2-1B01-TT](#) [G2-1B02-ST](#) [G2-DA03-ST](#)  
[G2-DA03-TT](#) [G2-DA06-TT](#) [3-1617776-2](#) [CTA2425](#) [TLP3131\(F\)](#) [LBA110S](#) [LBB110S](#) [LCA110LSTR](#)