



ORIENT

Photo coupler

Product Data Sheet

Part Number: OR-6N135&6N136

Customer: _____

Date: _____

SHENZHEN ORIENT COMPONENTS CO ., LTD

Block A 3rd Floor No.4 Building,Tian'an Cyber Park,Huangge Rd,LongGang Dist,Shenzhen,GD

TEL: 0755-29681816

FAX: 0755-29681200

www.orient-opto.com

1. Features

- (1) High speed - 1MBd model
- (2) Adapted to the dual-in-line, lead spacing width, surface installation.
- (3) Store output.
- (4) Safety approval
 - UL approved (No.E323844)
 - VDE approved (No.40029733)
 - CQC approved (No.CQC19001231254)
- (5) In compliance with RoHS, REACH standards
- (6) MSL Class I

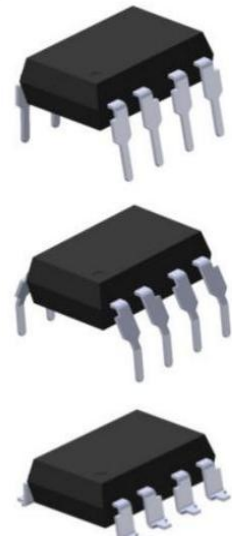

2. Instructions

OR-6N135/6N136 consists of highly efficient AlGaAs light-emitting diodes and high-speed optical detectors. The design provides good ac and dc isolation at the input and output ends of the photoelectric coupler. Connections related to photo diode biasing can improve the speed of conventional photo transistor couplers by reducing the capacitance of the matrix collector. Internal shielding ensures high transient immunity in general mode. Ensure the common-mode transient immunity to 1 kv/μsec.

3. Application Range

- (1) line receiver isolation
- (2) A/ D, D/A converted digital signal isolation
- (3) eliminate noise from the ground loop
- (4) switching power supply
- (5) alternative pulse transformers
- (6) motor control system
- (7) interface of microprocessor system, computer and peripheral equipment

4. Functional Diagram

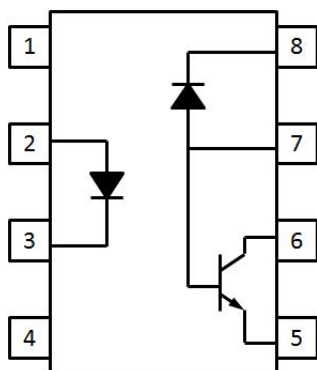

Pin Configuration

- 1. No Connection
- 2. Anode
- 3. Cathode
- 4. No Connection
- 5. Gnd
- 6. V_{out}
- 7. V_B
- 8. V_{CC}

5. Absolute Maximum Ratings (Ta=25°C) *1

Parameter		Symbol	Rated Value	Unit
Input	Average Forward Input Current	I_F	25	mA
	Reverse Input Voltage	V_R	5	V
	Power Dissipation	P_I	45	mW
Output	Output Collector Current	I_O	8	mA
	Output Collector Voltage	V_O	20	V
	Output Collector Power Dissipation	P_O	100	mW
Supply Voltage		V_{CC}	30	V
Insulation Voltage		V_{iso}	5000	V _{rms}
Working Temperature		T_{opr}	-40 ~ +110	°C
Storage Temperature		T_{stg}	-55 ~ +125	
*2 Soldering Temperature		T_{sol}	260	

*1. Room temperature = 25 °C. Exceeding the maximum absolute rating can permanently damage the device. Working long hours at the maximum absolute rating can affect reliability.

*2. soldering time is 10 seconds

6. Electrical optical characteristics (at TA=25°C)

Parameter		Symbol	Min	Typ	Max	Unit	Condition	
Input	Forward Voltage	V_F	---	1.4	1.7	V	$I_F = 16\text{mA}$	
	Reverse Voltage	V_R	5	---	---	V	$I_R = 10\mu\text{A}$	
Output	High Level Output Current	I_{OH}	---	---	0.5	uA	$V_{CC}=5.5\text{V}, V_O=5.5\text{V}, I_F=0\text{mA}$	
			---	---	1		$V_{CC}=15\text{V}, V_O=15\text{V}, I_F=0\text{mA}$	
	Low Level Supply Current	I_{CCL}	---	140	200	uA	$I_F=16\text{mA}, V_O=\text{open}, V_{CC}=15\text{V}$	
	High Level Supply Current	I_{CCH}	---	0.01	1	uA	$I_F=0\text{mA}, V_O=\text{open}, V_{CC}=15\text{V}, TA=25^\circ\text{C}$	
---			---	2	uA	$I_F=0\text{mA}, V_O=\text{open}, V_{CC}=15\text{V}$		
Transfer Characteristics	Current Transfer Ratio	CTR	OR-6N135	7	---	50	%	$I_F = 16\text{mA}, V_O = 0.4\text{V}, V_{CC}=4.5\text{V}, TA=25^\circ\text{C}$
			OR-6N136	19	---	50		
			OR-6N135	5	---	---		
			OR-6N136	15	---	---		
	Logic Low Output Voltage	V_{OL}	OR-6N135	---	0.18	0.4	V	$I_F = 16\text{mA}, I_O = 1.1\text{mA}, V_{CC}=4.5\text{V}, TA=25^\circ\text{C}$
			OR-6N136	---	0.25	0.4		$I_F = 16\text{mA}, I_O = 3\text{mA}, V_{CC}=4.5\text{V}, TA=25^\circ\text{C}$
			OR-6N135	---	---	0.5		$I_F = 16\text{mA}, I_O = 0.8\text{mA}, V_{CC}=4.5\text{V}$
			OR-6N136	---	---	0.5		$I_F = 16\text{mA}, I_O = 2.4\text{mA}, V_{CC}=4.5\text{V}$

7. Switching Characteristics (at TA=25°C)

Parameter		Symbol	Min	Typ	Max	Unit	Condition
Propagation delay time to output Low level	OR-6N135	t _{PHL}	---	0.09	1.5	us	R _L =4.1kΩ I _F =16mA
	OR-6N136		---	0.1	0.8	us	R _L =1.9kΩ I _F =16mA
Propagation delay time to output High level	OR-6N135	t _{PLH}	---	0.8	1.5	us	R _L =4.1kΩ I _F =16mA
	OR-6N136		---	0.4	0.8	us	R _L =1.9kΩ I _F =16mA
Logic High Common Mode Transient Immunity	OR-6N135	CM _H	1	10	---	kV/μs	V _{CM} =10Vp-p, R _L =4.1kΩ, I _F =0mA
	OR-6N136						V _{CM} =10Vp-p, R _L =1.9kΩ, I _F =0mA
Logic Low Common Mode Transient Immunity)	OR-6N135	CM _L	1	10	---	kV/μs	V _{CM} =10Vp-p, R _L =4.1kΩ, I _F =0mA
	OR-6N136						V _{CM} =10Vp-p, R _L =1.9kΩ, I _F =0mA

Recommended temperature range (TA = 0 °C ~ 70 °C), unless otherwise specified power supply for 5V.

Typical values of TA = 25 °C.

8. Isolation characteristics (at TA=25°C)

Parameter	Symbol	Min	Typ	Max	Unit	Condition
Input-Output Insulation Leakage Current	I _{I-O}	—	—	1	μA	45% RH, t=5s, V _{I-O} =3kV DC, T _A =25 C
Withstand Insulation Test Voltage	V _{ISO}	5000	—	—	V _{RMS}	RH ≤ 50%, t =1min, T _A =25°C
Input-Output Resistance	R _{I-O}	5x10 ¹⁰	10 ¹²	—	Ω	V _{I-O} =5000V DC

9. Order Information

Part Number

OR-6N13XY-Z

Note

6N13X = Part Number (6N135 or 6N136)
 Y = Lead form option (S, M or none)
 Z = Tape and reel option (TA,TA1 or none).

Option	Description	Packing quantity
None	Standard SMD Option	45 units per tube
M	Wide lead bend (0.4 inch spacing)	45 units per tube
TA	Surface mount lead form (low profile) + TA tape & reel option	1000 units per reel
TA1	Surface mount lead form (low profile) + TA1 tape & reel option	1000 units per reel

10. Naming Rule

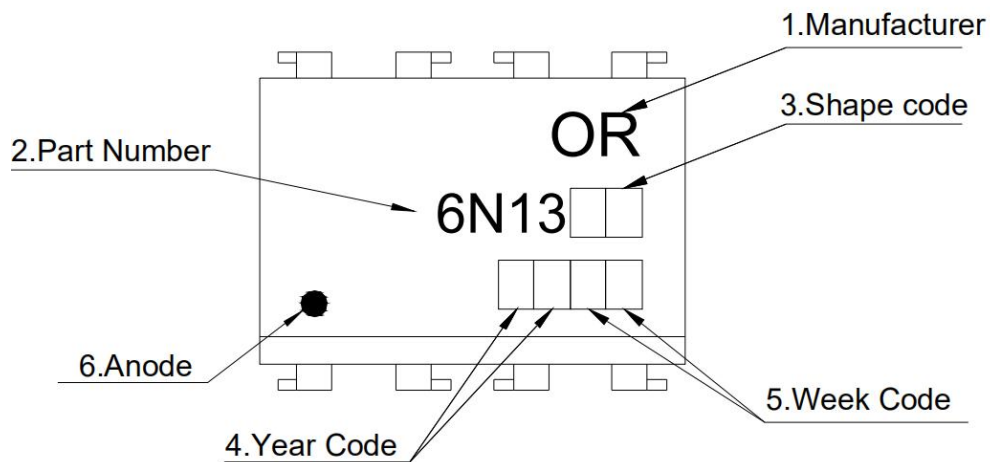

NOTE:

1. Manufacturer : ORIENT.
2. Part Number : 6N135 or 6N136 .
3. Shape Code .
4. Year Code : '21' means '2021' and so on.
5. Week Code : 01 means the first week, 02 means the second week and so on.
6. Anode.

11. Outer Dimension

(1) OR-6N13X

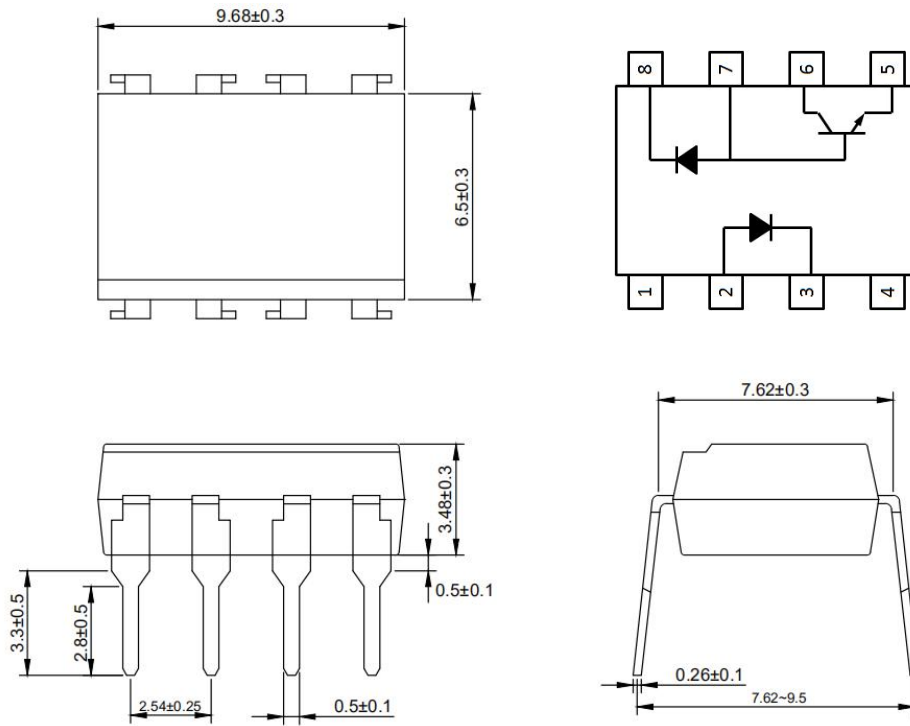

(2) OR-6N13XM

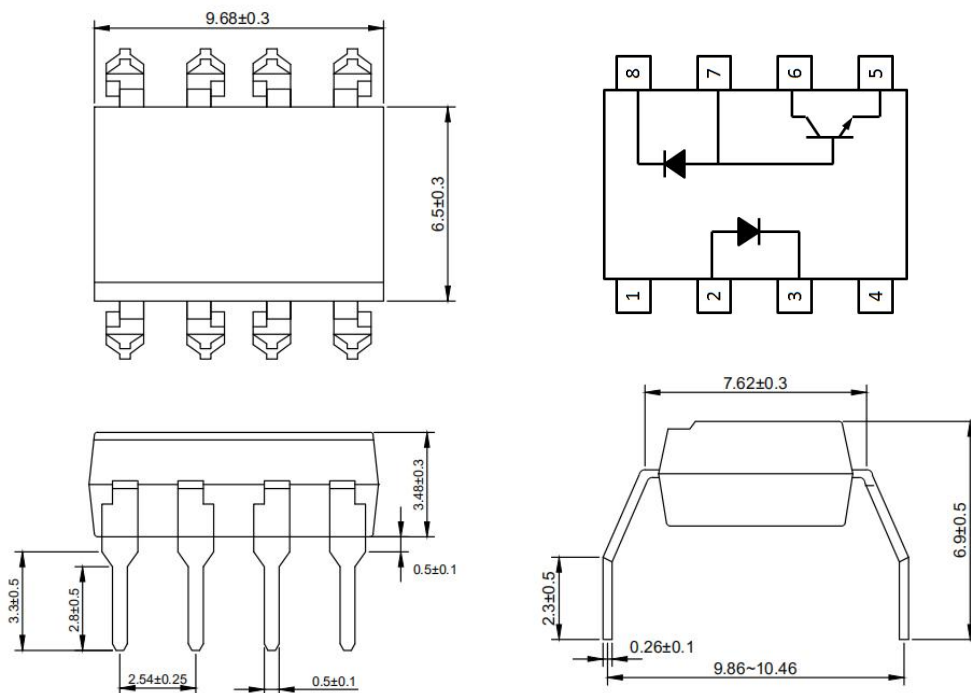

(3) OR-6N13XS

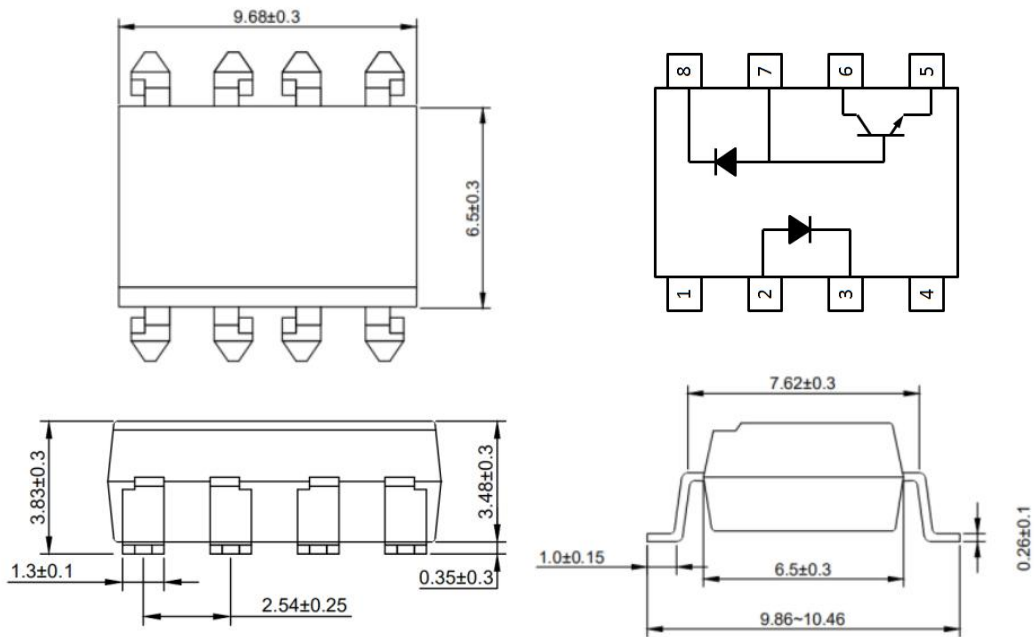

12. Recommended Foot Print Patterns (Mount Pad)

(unit: mm)

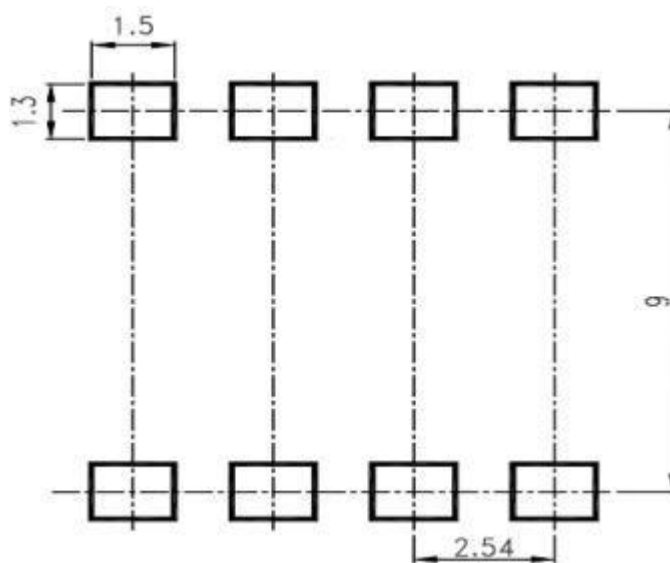

13. Taping Dimensions

(1)OR-6N13XS-TA

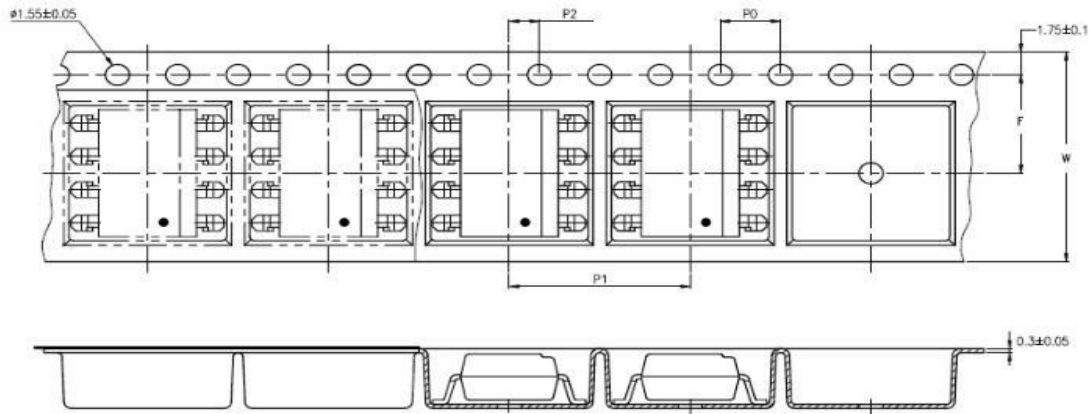

(2)OR-6N13XS-TA1

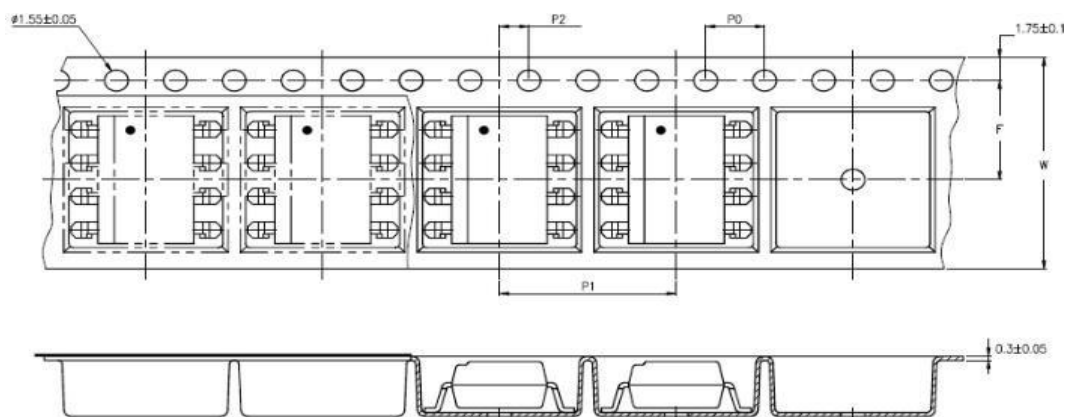

type	symbol	Dimensions: mm (inches)
bandwidth	W	16±0.3 (0.63)
pitch	P0	4±0.1 (0.15)
pitch	F	7.5±0.1 (0.295)
	P2	2±0.1 (0.079)
interval	P1	12±0.1 (0.472)

Encapsulation type	TA/TA1
Amount(pcs)	1000

14. Package Dimension

DIP Type

Packing Information	
Packing type	Tube
Qty per Tube	45pcs
Small box (Inner) Dimension	525*128*60mm
Large box (Outer) Dimension	545*290*335mm
The Amount per Inner Box	2,250pcs
The Amount per Outer Box	22,500pcs

SOP Type

Packing Information	
Packing type	Reel type
Tape Width	16mm
Qty per Reel	1,000pcs
Small box (inner) Dimension	345*345*58.5mm
Large box (Outer) Dimension	620x360x360mm
Max qty per small box	2,000pcs
Max qty per large box	20,000pcs

(2)Packing Label Sample



Note:

1. Material Code :Product ID.
2. P/N :Contents with "Order Information" in the specification.
3. Lot No. :Product data.
4. D/C :Product weeks.
5. Quantity :Packaging quantity.

15. Reliability Test

NO.	ITEMS	Reliability Testing				
		QTY. (Pcs)	Condition	Process	Device	Standard
1	RSH 耐焊接热	22	260±5°C	5s/3 次	锡炉	JESD22-A106
2	HTSL 高温存储	77	125°C	168 hrs	高温烤箱 测试仪	JESD22-A103
				500 hrs		
				1000 hrs		
3	LTSL 低温存储	77	-40°C	168 hrs	低温箱 测试仪	JESD22-A119
				500 hrs		
				1000 hrs		
4	TC 温度循环	77	H:125°C 15min ↓5min L:-55°C 15min	300 cycle	冷热冲击 机	JESD22-A104
5	TS 温度冲击	77	H:100°C 5min ↓15s L:-40°C 5min	300 cycle	冷热冲击 机	JESD22-A106
6	HTOL 高温操作	77	100°C IF=10mA Vcc=5V	168 hrs	高温烤箱 测试仪、 老化电路 板	JESD22-A108
				500 hrs		
				1000 hrs		
7	ESD- HBM 人体模式	22	≥8KV 1Cycle	1次	ESD静电 测试仪	JESD22-A114
8	SD 可焊性	22	Pb-free 245±5°C	5s/1次	锡炉	JESD22-B102
9	HTHB 温湿寿命 试验	77	85°C,85%RH IF=10mA,Vcc=5V	168 hrs	恒温恒湿 机, 测试 仪	JESD22-A101
				500 hrs		
				1000 hrs		
10	Autoclave 压力锅	77	Ta=121 °C,100%RH,2atm	96hrs	压力锅	JESD22-A102

16. Temperature Profile Of Soldering

(1) IR Reflow soldering (JEDEC-STD-020C compliant)

Note: one solder backflow is recommended under the conditions described below in the temperature and time profile. Do not weld more than three times.

Profile item	Conditions
Preheat - Temperature Min (T Smin) - Temperature Max (T Smax) - Time (min to max) (ts)	150°C 200°C 90±30 sec
Soldering zone - Temperature (TL) - Time (t L)	217°C 60 sec
Peak Temperature	260°C
Peak Temperature time	20 sec
Ramp-up rate	3°C / sec max.
Ramp-down rate from peak temperature	3~6°C / sec
Reflow times	≤3

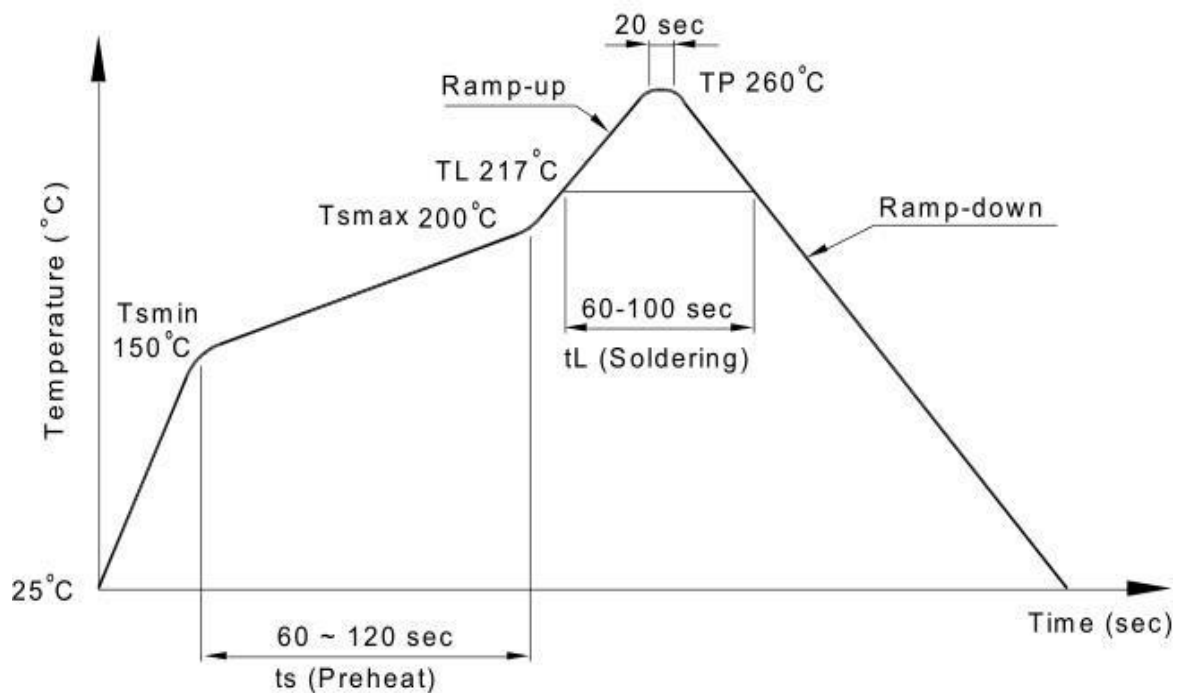

(2) Wave soldering (JEDEC22A111 compliant)

One-time welding is recommended under the temperature condition.

Temperature	260+0/-5°C
Time	10 sec
Preheat temperature	5 to 140°C
Preheat time	30 to 80 sec

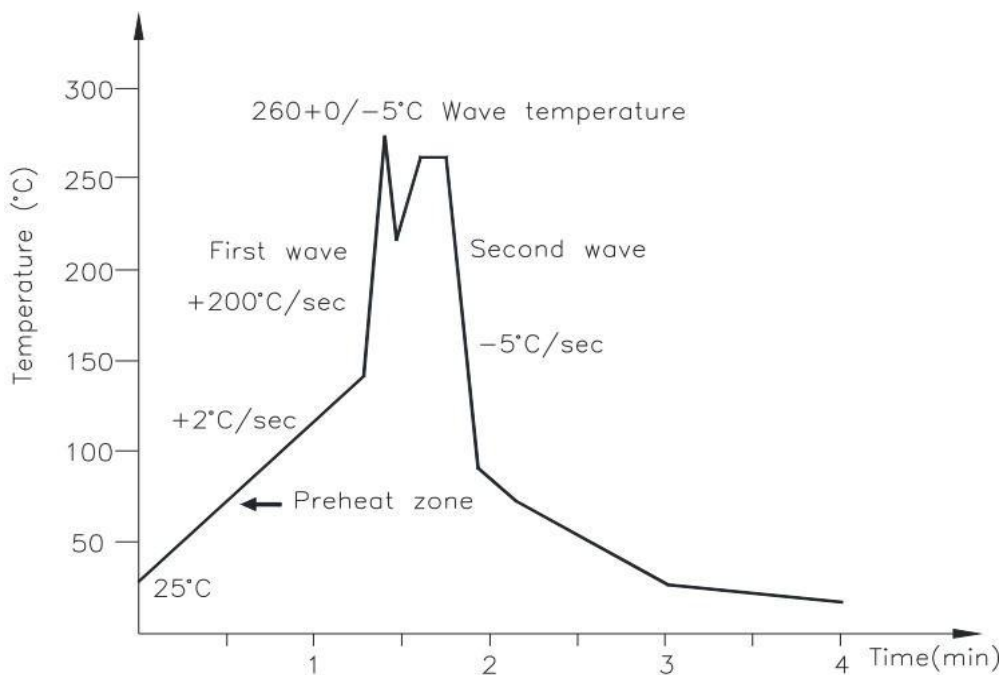

(3) Hand soldering by soldering iron

Single lead welding is allowed in each process and one-time welding is recommended.

Temperature	380+0/-5°C
Time	3 sec max

17. Switching time test circuit

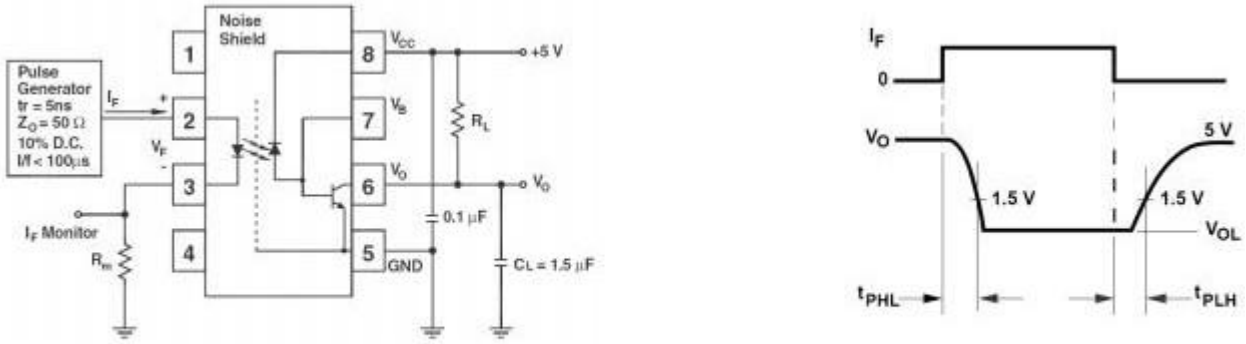

Figure 1: Test Circuit for t_{PHL} and t_{PLH}

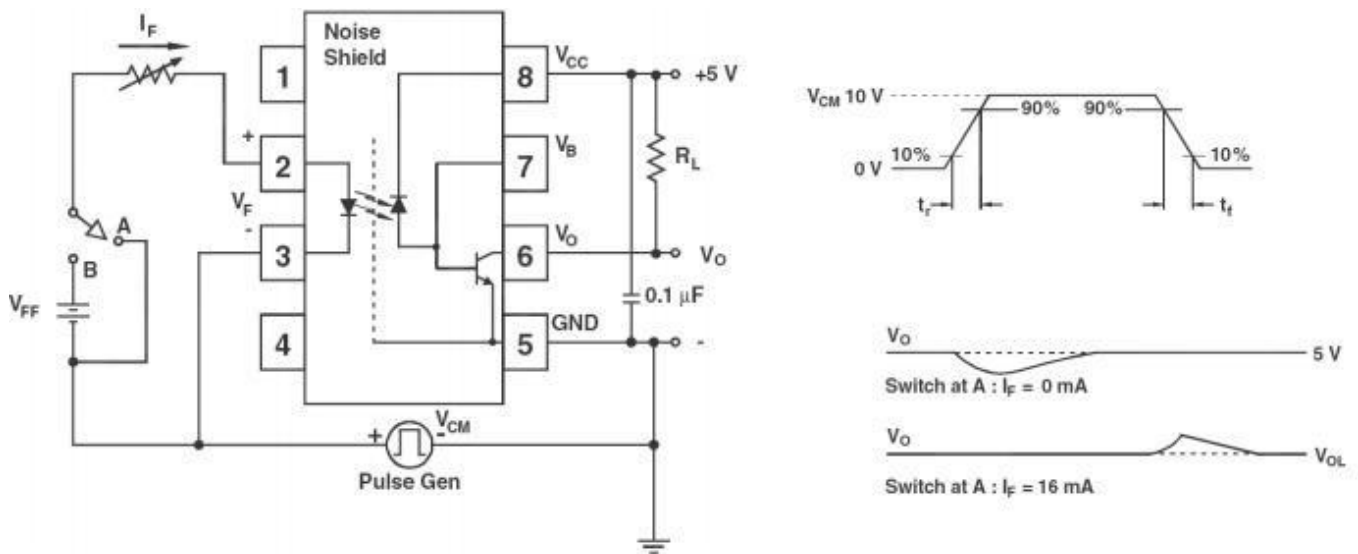

Figure 2: Single Channel Test Circuit for Common Mode Transient Immunity

18. Characteristics Curve

Figure 3: DC and pulsed transfer characteristics

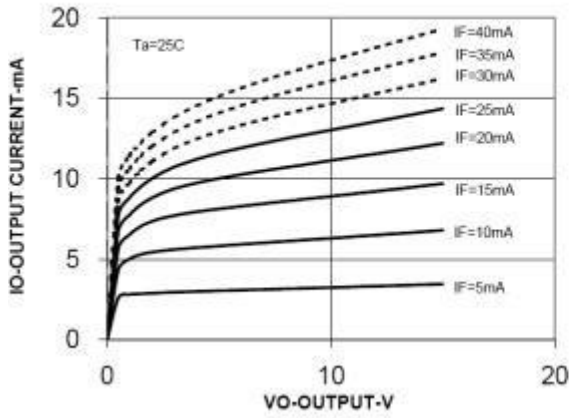

Figure 6: Current transfer ratio vs. input current

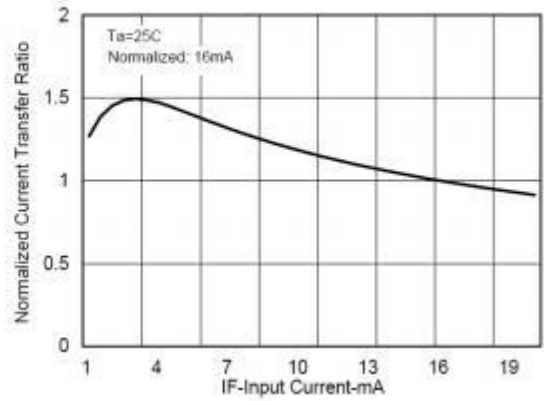

Figure 4: Input current vs. forward voltage

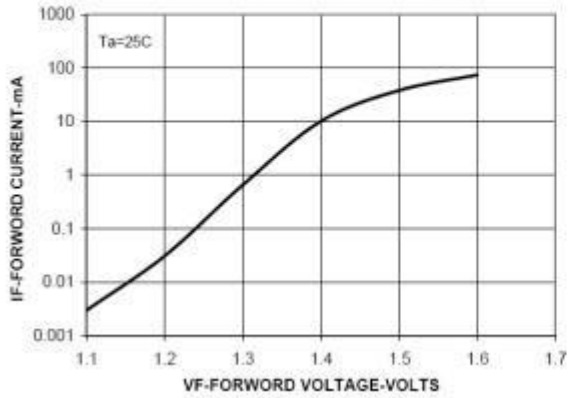

Figure 7: Current transfer ratio vs. temperature

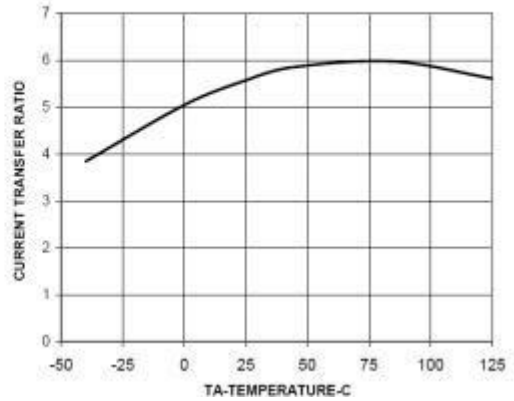

Figure 5: Logic high output current vs. temperature

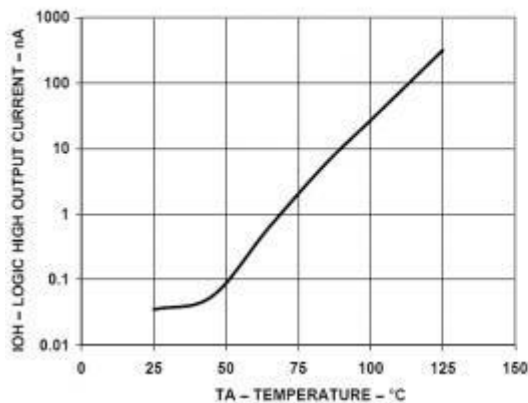

Figure 8: Small-signal current transfer ratio vs. quiescent current

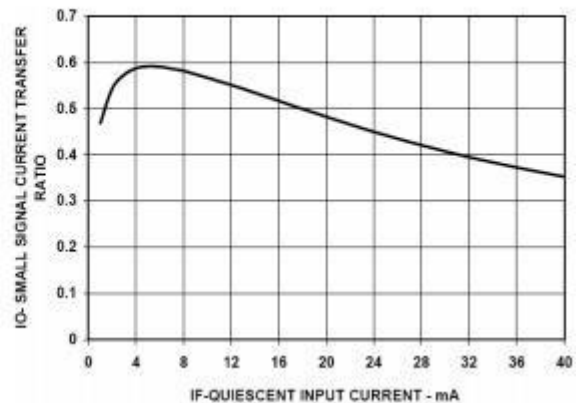

Figure 9: Propagation delay time vs. temperature

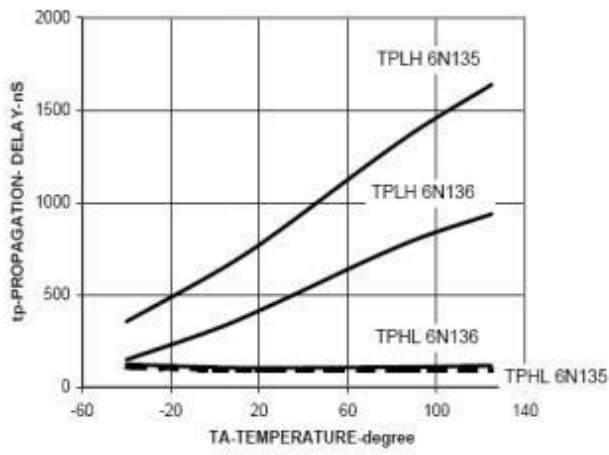
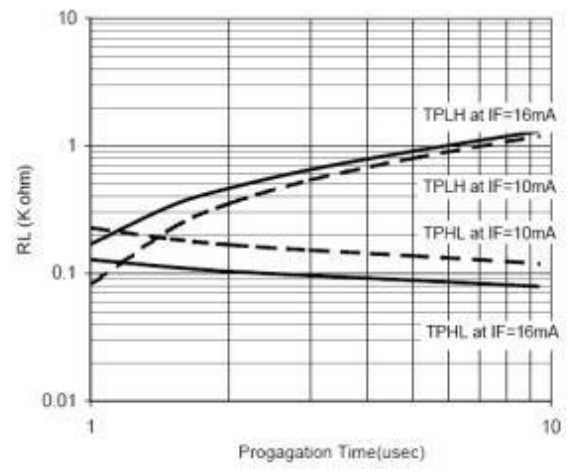

Figure 10: Propagation delay time vs. load resistance



X-ON Electronics

Largest Supplier of Electrical and Electronic Components

Click to view similar products for [Photodiode Output Optocouplers](#) category:

Click to view products by [Orient](#) manufacturer:

Other Similar products are found below :

[TLP590B\(C,F\)](#) [TLP7820\(A-LF4.E\(O](#) [LTV-244-GB-G](#) [LTV2301GB-V-G](#) [EL816S1\(C\)\(TU\)](#) [EL817S1\(C\)\(TU\)-VG](#) [GX357NC](#) [PC817B](#)
[PC817C](#) [LTV-341W-TA1-H](#) [LTV-176G](#) [LTV-1003-TP1-G](#) [LTV-247-G-RT](#) [PC817B-MS](#) [FOC-817C-F](#) [CYPS2501-1\(K\)](#)
[CYTLP2362\(TPD2\)](#) [OR-3H7C-TP-G-\(GK\)](#) [ORPC-817MC-F](#) [ORPC-817D-C](#) [ORPC-817SB-TP-F](#) [PS2801C-4-F3-A/M](#) [PC817B](#)
[TLP183\(YH-TPL,E\(T](#) [TLP183\(GRH-TPL,E\(T](#) [TLP183\(TPL,E\(T](#) [TLP291\(BL-TP,SE\(T](#) [TLP184\(V4GBTL,SE\(T](#) [TLP785\(BLL-TP6,F\(C](#)
[TLP293\(GRH-TPL,E\(T](#) [TLP383\(D4GL-TR,E](#) [TLP185\(BLL-TL,SE\(T](#) [TLP2309\(TPL,E\(O](#) [TLP785\(BL-TP6,F\(C](#) [TLP185\(GRL-TL,SE\(T](#)
[TLP785\(GR-TP6,F\(C](#) [TLP183\(BL-TPL,E\(T](#) [TLP2398\(TPL,E\(T](#) [TLP127GB-S](#) [LTV-354T-A\(UMW\)](#) [6N136S\(UMW\)](#) [PC817B-S](#) [FOC-817C](#)
[EL1018](#) [IS3H7A](#) [IS121GB](#) [IS2701-1BL](#) [IS180](#) [IS2805-1](#) [ISP281B](#)