



# ORIENT

## Photocoupler

### Product Data Sheet

Name: OR-MOC305X

Customer: \_\_\_\_\_

Date: \_\_\_\_\_

**1. Features**

- (1) Isolation voltage between input and output Viso : 5,000V rms
- (2) 6pin non zero-cross optoisolators triac driver output
- (3) High repetitive peak off-state voltage VDRM : Min. 600V
- (4) High critical rate of rise of off-state voltage( dV/dt : MIN. 1000V / s )
- (5) Dual-in-line package : OR-MOC3050, OR-MOC3051, OR-MOC3052, OR-MOC3053
- (6) Wide lead spacing package : OR-MOC3050M,OR- MOC3051M, OR-MOC3052M,OR-MOC3053M
- (7) Surface mounting package : OR-MOC3050S,OR- MOC3051S, OR-MOC3052S, OR-MOC3053S
- (8) Tape and reel packaging : OR-MOC3050S-TA, OR-MOC3051S-TA, OR-MOC3052S-TA, OR-MOC3053S-TA,OR-MOC3050S-TA1, OR-MOC3051S-TA1, OR-MOC3052S-TA1, OR-MOC3053S-TA1

**2. Description**

The OR-MOC305X consists of a non zero crossing photo triac, optically coupled to a gallium arsenide infrared emitting diode. The OR-MOC305X is housed in the DIP6 package and guarantees insulation thickness. Therefore, the OR-MOC305X meets the reinforced insulation class requirements of international safety standards.

**3.Application Range**

- AC Motor Drives
- AC Motor Starters
- Static power switch
- Lighting Controls
- Solenoid/Valve Controls
- Solid State Relays
- Temperature Controls

**4. Absolute Maximum Ratings (Ta=25°C)**

Parameter		Symbol	Rated Value	Unit
Input	Forward Current	I <sub>F</sub>	50	mA
	Junction Temperature	T <sub>J</sub>	125	°C
	Reverse Voltage	V <sub>R</sub>	6	V
	Power Dissipation	P	100	mW
Output	Off-State Output Terminal Voltage	V <sub>DRM</sub>	600	V
	Peak Repetitive Surge Current (PW=1ms, 120 pps)	I <sub>TSM</sub>	1	A
	Junction Temperature	T <sub>J</sub>	125	°C
	Collector Power Dissipation	P <sub>C</sub>	300	mW
Total Power Dissipation		P <sub>tot</sub>	330	mW
*1 Insulation Voltage		V <sub>iso</sub>	5000	Vrms
Working Temperature		Topr	-40 ~ + 100	°C
Deposit Temperature		T <sub>stg</sub>	-55 ~ + 150	
*2 Soldering Temperature		T <sub>sol</sub>	260	

Notes:

\*1 AC for 1 minute, R.H.= 40 ~ 60% R.H. In this test, pins 1, 2&3 are shorted together, and pins 4, 6 are shorted together.

\* 2 For 10 seconds

5. Electrical Optical Characteristics at Ta=25°C

Parameter		Symbol	Condition	Min	Typ.*	Max	Unit	
Input	Forward Voltage	$V_F$	$I_F=20mA$	---	1.2	1.6	V	
	Reverse Current	$I_R$	$V_R=6V$	---	0.05	10	$\mu A$	
Output	1. Peak Blocking Current, Either Direction	$I_{DRM}$	$V_{DRM} = 600V$	---	10	100	nA	
	Peak On-State Voltage, Either Direction	$V_{TM}$	$I_{TM}=100mA$ Peak	---	1.7	3.0	V	
	2. Critical rate of Rise of Off-State Voltage	dv/dt	$V_{in}=240V_{rms}$	1000	---	---	V/us	
Couple	3. Led Trigger Current, Current Required to Latch Output, Either Direction	OR-MOC3050	$I_{FT}$	Main Terminal Voltage = 3V	---	---	30	mA
		OR-MOC3051			---	---	15	
		OR-MOC3052			---	---	10	
		OR-MOC3053			---	---	5	
	Holding Current, Either Direction	$I_H$		---	200	---	$\mu A$	

\*1. Test voltage must be applied within dv/dt rating.

\*2. This is static dv/dt. Commutating dv/dt is a function of the load-driving thyristor(s) only.

\*3. All devices are guaranteed to trigger at an  $I_F$  value less than or equal to max  $I_{FT}$ .

Therefore, recommended operating  $I_F$  lies between max  $I_{FT}$ , 30 mA for OR-MOC3050, 15 mA for OR-MOC3051, 10 mA for OR-MOC3052, 5 mA for OR-MOC3053, and absolute max  $I_F$  (50mA).

## 6.Naming Rule

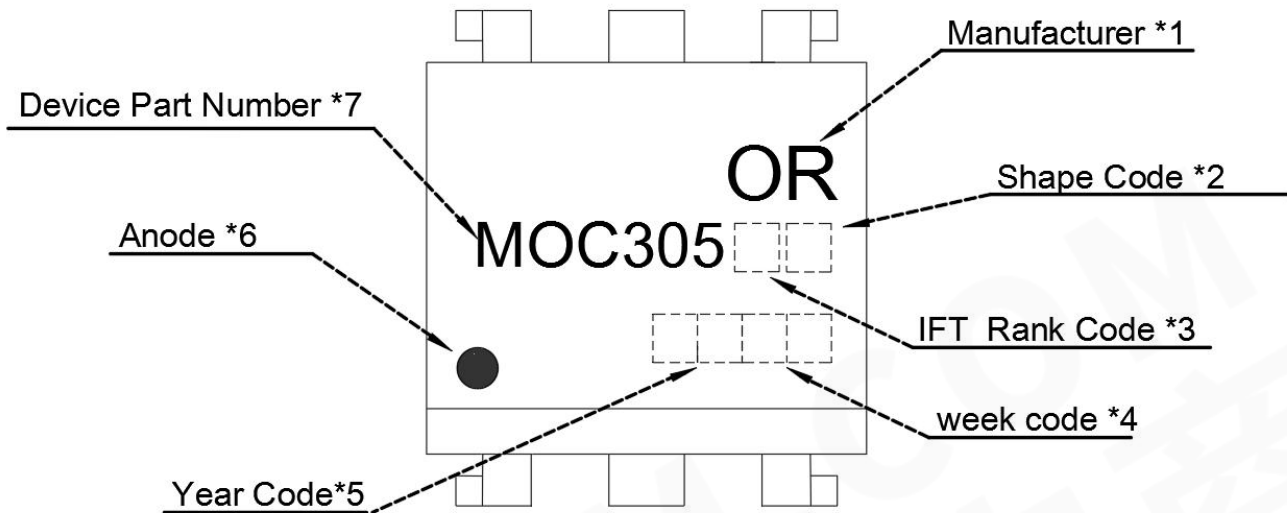

### NOTE:

- (1) Manufacturer denotes Shenzhen Orient Components Co ., Ltd.
- (2) □ denotes Shape Code .
- (3) □ denotes IFT Rank Code ,0=MOC3050; 1=MOC3051; 2=MOC3052; 3=MOC3053.
- (4) □□□ denotes Week code.
- (5) □□ denotes Year code.
- (6) ● denotes Anode.
- (7) MOC305 denotes Device Part Number.
- (8) Unit:mm

### 7. Package Dimension

#### (1).OR-MOC305X

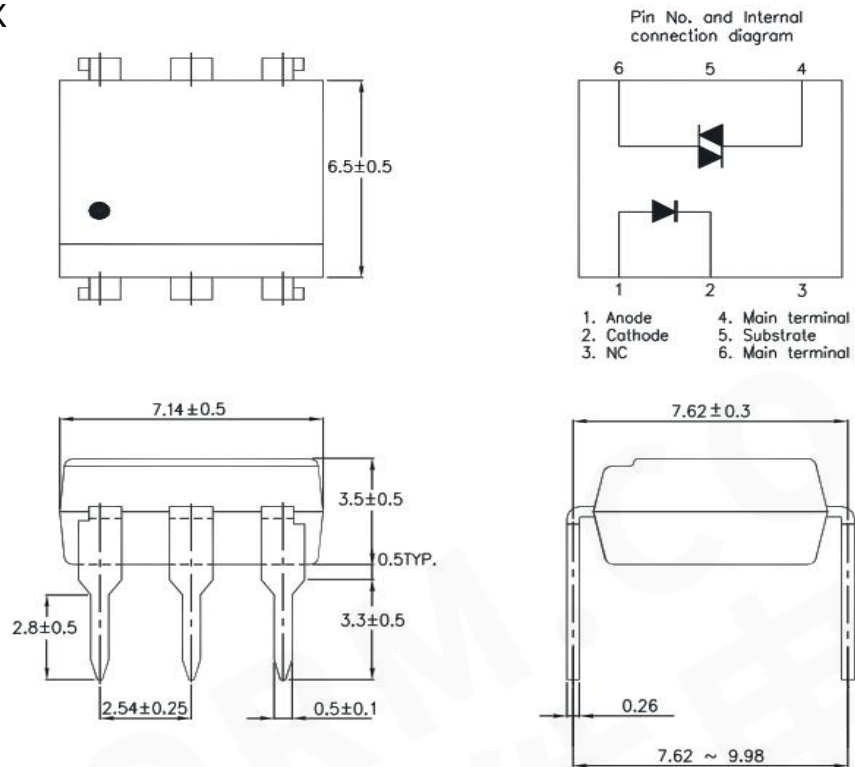

#### (2).OR-MOC305XM

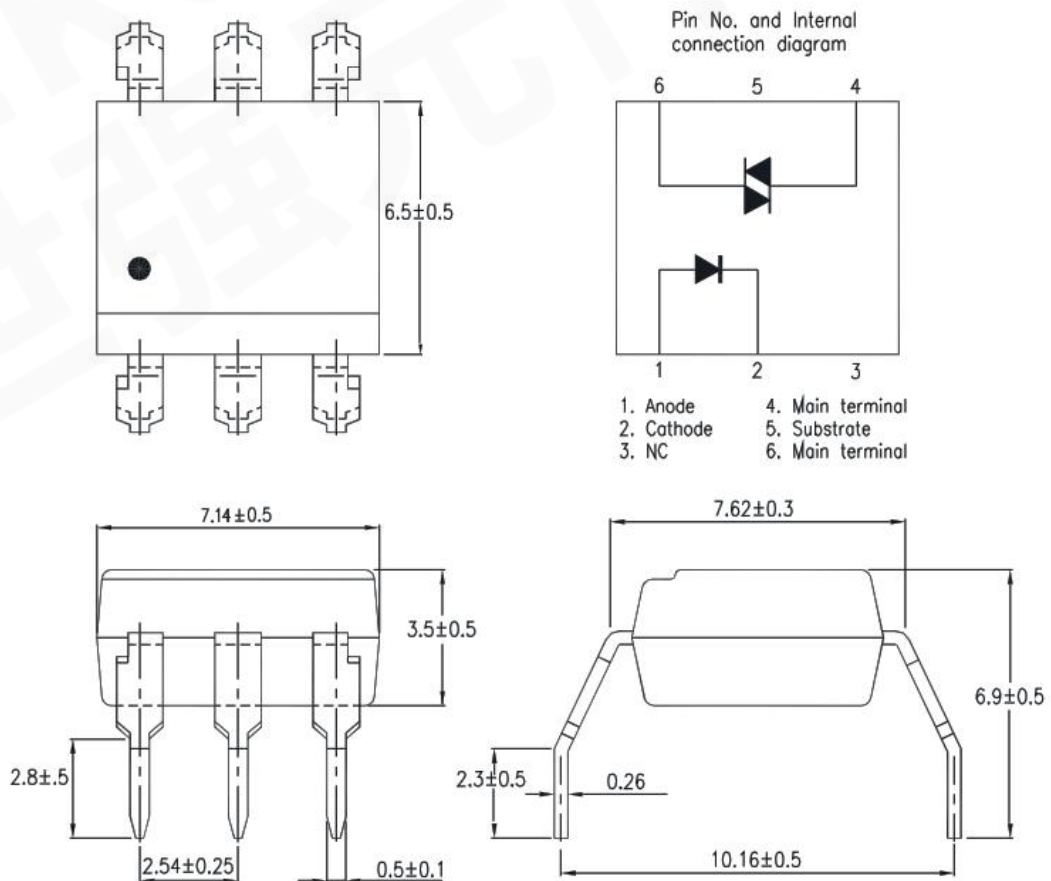

(3).OR-MOC305XS

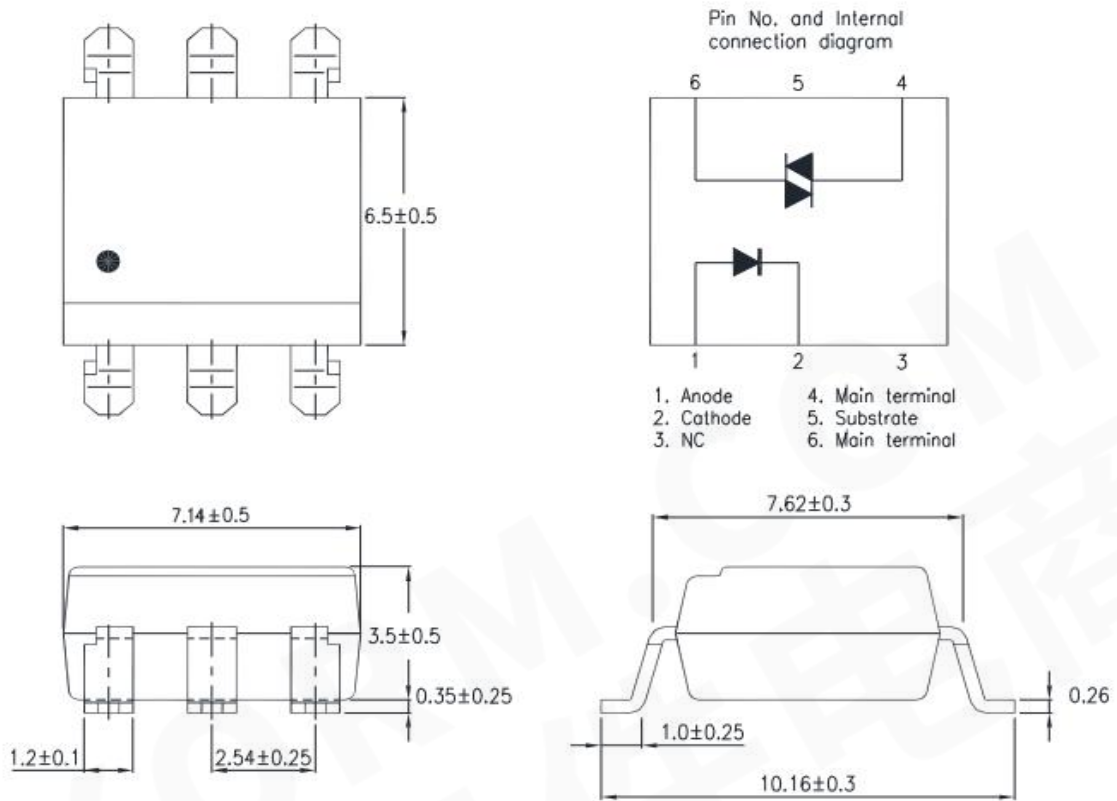

8. Taping Dimensions

(1). OR-MOC305XS-TA

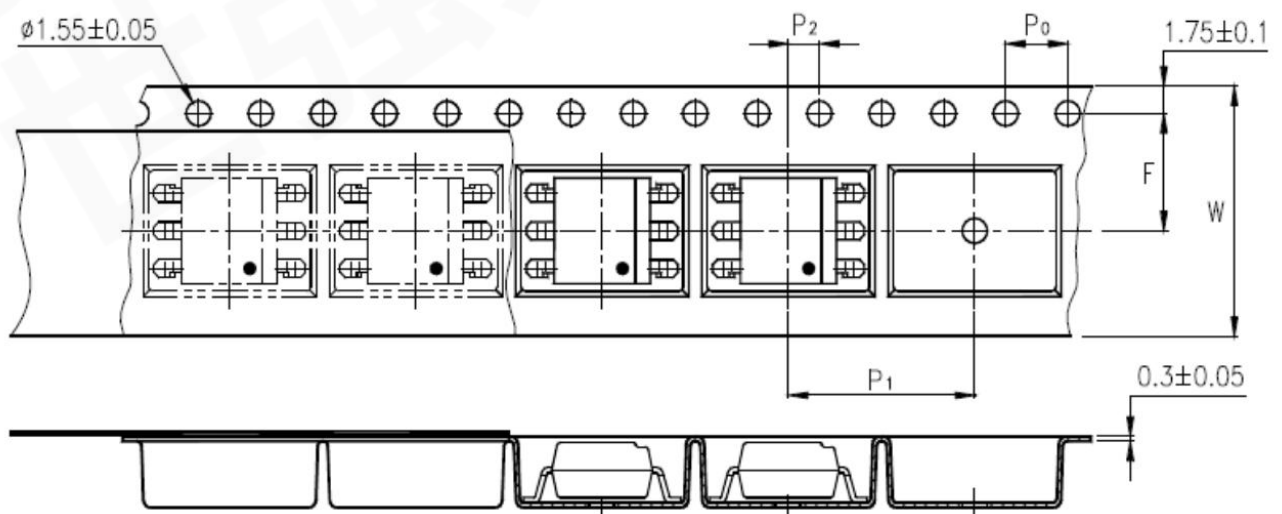

2. OR-MOC305XS-TA1

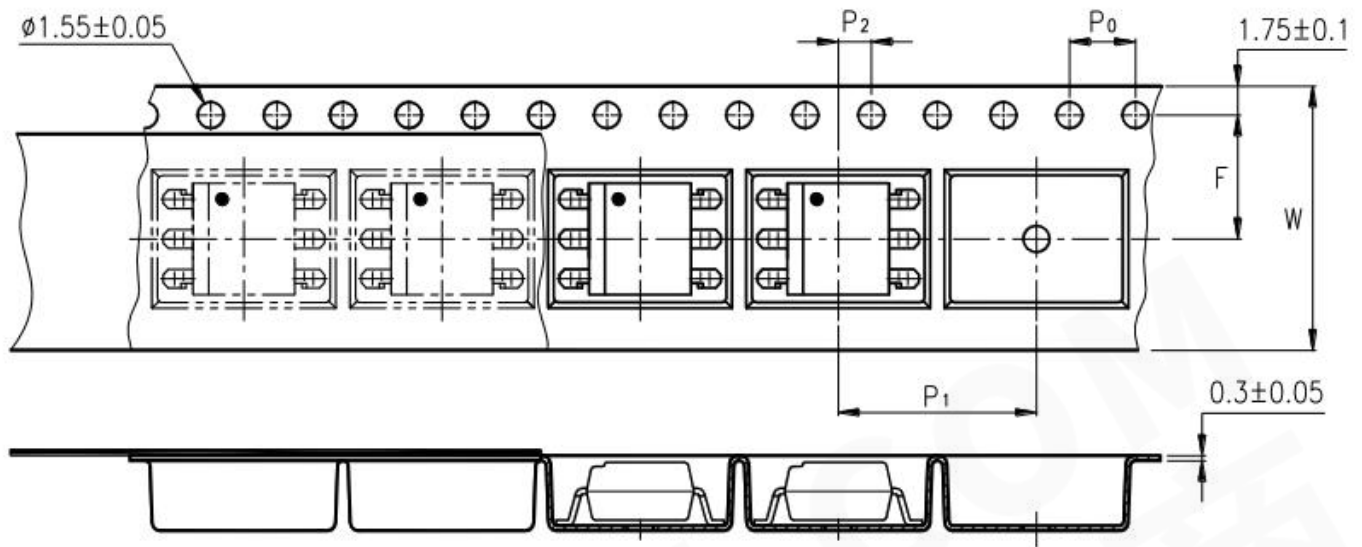

Description	Symbol	Dimension in mm (inch)
Tape wide	W	$16 \pm 0.3$ (0.63)
Pitch of sprocket holes	$P_0$	$4 \pm 0.1$ (0.15)
Distance of compartment	F	$7.5 \pm 0.1$ (0.295)
	$P_2$	$2 \pm 0.1$ (0.079)
Distance of compartment to compartment	$P_1$	$12 \pm 0.1$ (0.472)

Package Type	OR-MOC305XS series(TA/TA1)
Quantities(pcs)	1000

### 9. Temperature Profile Of Soldering

(1).IR Reflow soldering (JEDEC-STD-020C compliant)

One time soldering reflow is recommended within the condition of temperature and time profile shown below. Do not solder more than three times.

Profile item	Conditions
Preheat	
- Temperature Min ( $T_{smin}$ )	150°C
- Temperature Max ( $T_{smax}$ )	200°C
- Time (min to max) (ts)	90±30 sec
Soldering zone	
- Temperature (TL)	217°C
- Time ( $t_L$ )	60 sec
Peak Temperature( $T_P$ )	260°C
Ramp-up rate	3°C / sec max.
Ramp-down rate	3~6°C / sec

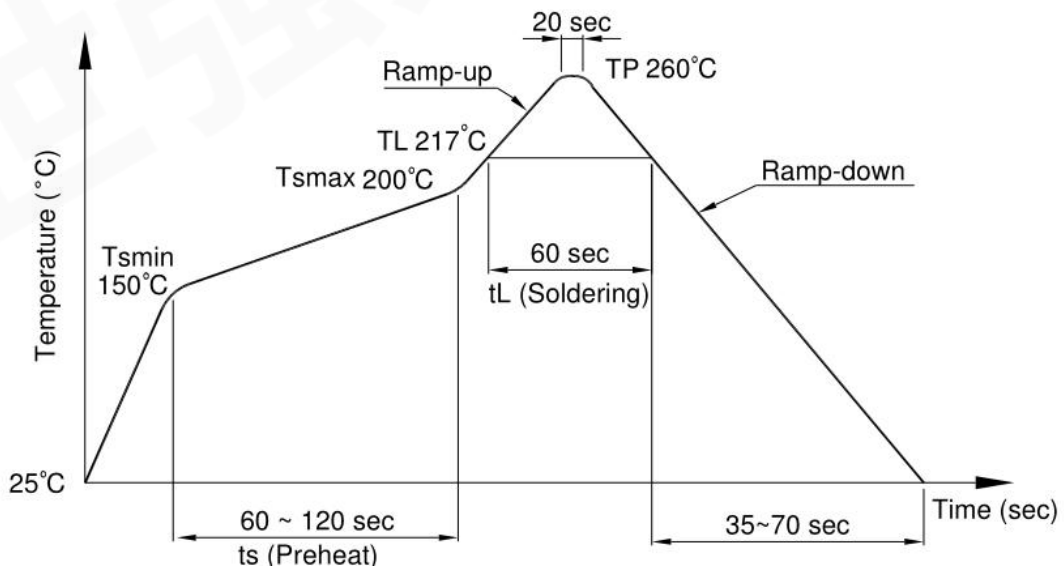



**(3) .Wave soldering (JEDEC22A111 compliant)**

One time soldering is recommended within the condition of temperature.

Temperature	260+0/-5°C
Time	10 sec
Preheat temperature	5 to 140°C
Preheat time	30 to 80 sec

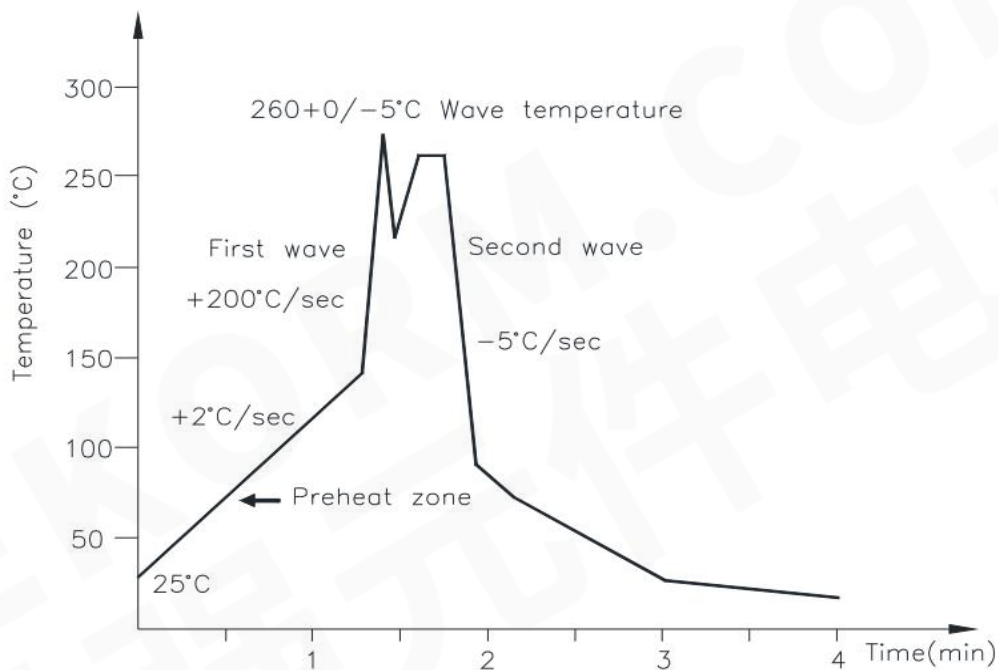

**(3).Hand soldering by soldering iron**

Allow single lead soldering in every single process. One time soldering is recommended.

Temperature	380+0/-5°C
Time	3 sec max

10. RECOMMENDED FOOT PRINT PATTERNS (MOUNT PAD)

Unit: mm

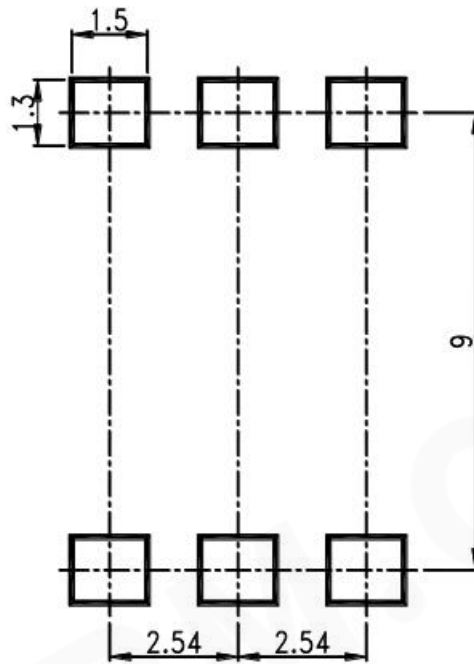

11.CHARACTERISTICS CURVES (TYPICAL PERFORMANCE)

Fig.1 Forward current vs Ambient temperature

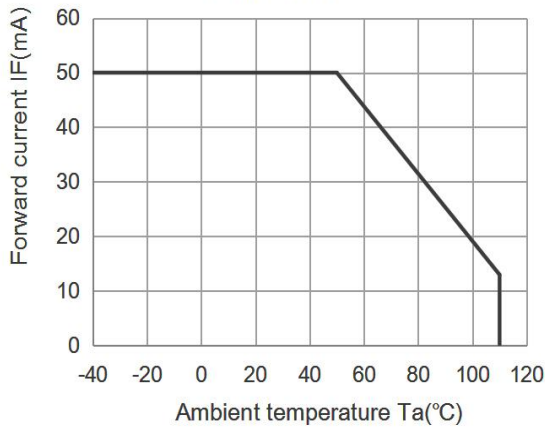

Fig.2 On-state current I<sub>TM</sub> (A) vs. Ambient temperature

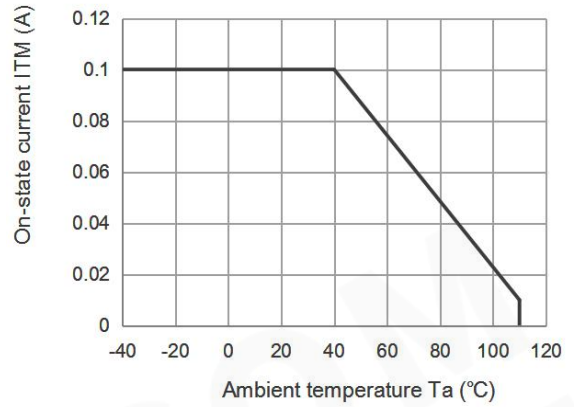

Fig.3 Minimum Trigger Current vs. Ambient temperature

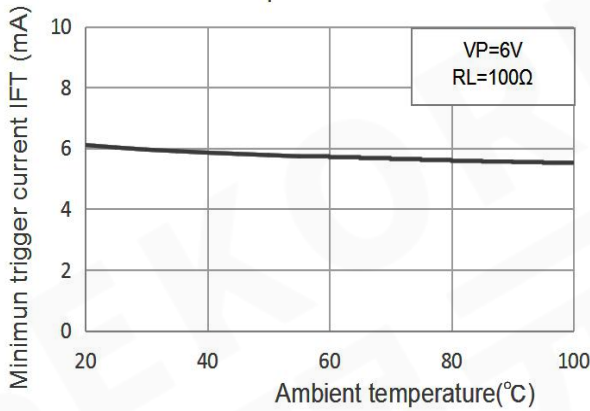

Fig.4 Forward current vs. Forward voltage

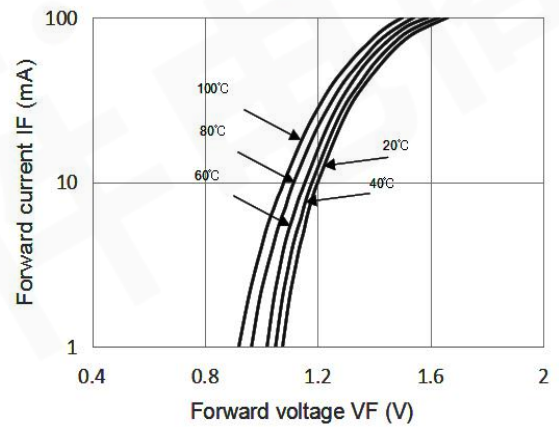

Fig.5 On-state voltage vs. Ambientn temperature

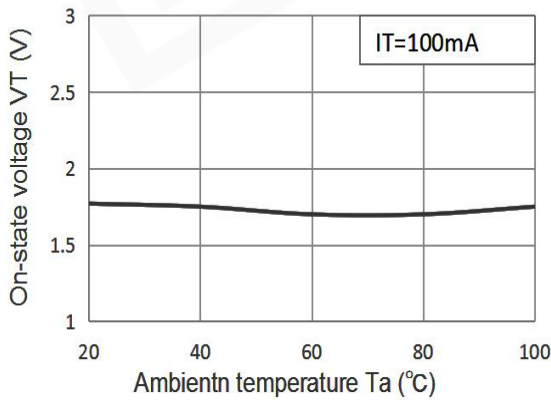

Fig.6 Holding current vs. Ambient temperature

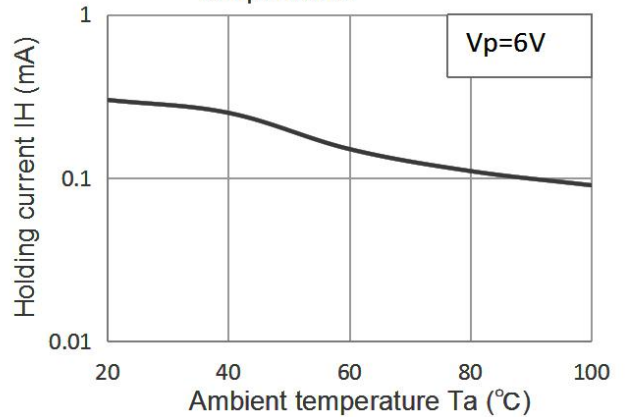

Fig.7 Repetitive peak off-state current vs. Temperature

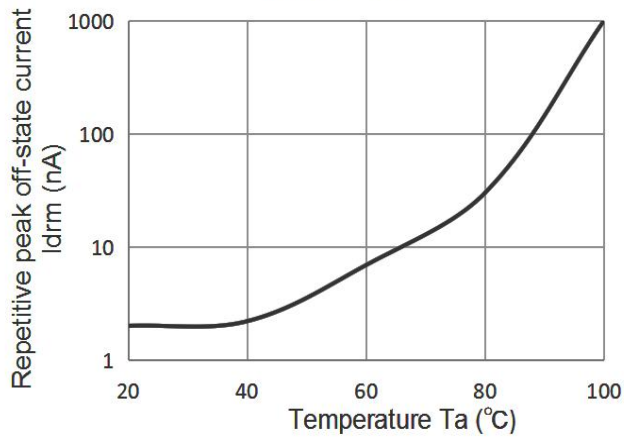
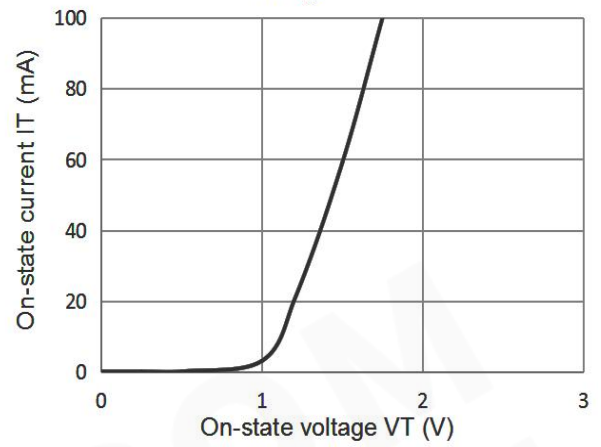
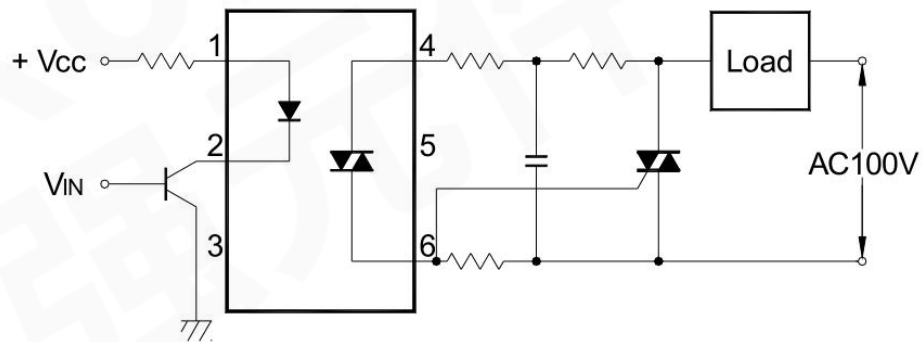

Fig.8 On-state current vs. On-state voltage



### Basic Operation Circuit

### Medium/High Power Triac Drive Circuit



► **Notes:**

① ORIENT is continually improving the quality, reliability, function or design and ORIENT reserves the right to make changes without further notices.

② When using this product, please observe the absolute maximum ratings and the instructions for use as outlined in this datasheet . ORIENT assumes no responsibility for any damage resulting from use of the product which does not comply with the absolute maximum ratings and the instructions included in this datasheet.

③ If there are any questions about the contents of this publication, please contact us at your convenience.

## X-ON Electronics

Largest Supplier of Electrical and Electronic Components

*Click to view similar products for [Photodiode Output Optocouplers](#) category:*

*Click to view products by [Orient](#) manufacturer:*

Other Similar products are found below :

[TLP590B\(C,F\)](#) [TLP7820\(A-LF4.E\(O](#) [LTV-244-GB-G](#) [LTV2301GB-V-G](#) [EL816S1\(C\)\(TU\)](#) [EL817S1\(C\)\(TU\)-VG](#) [GX357NC](#) [PC817B](#)  
[PC817C](#) [LTV-341W-TA1-H](#) [LTV-176G](#) [LTV-1003-TP1-G](#) [LTV-247-G-RT](#) [PC817B-MS](#) [FOC-817C-F](#) [CYPS2501-1\(K\)](#)  
[CYTLP2362\(TPD2\)](#) [OR-3H7C-TP-G-\(GK\)](#) [ORPC-817MC-F](#) [ORPC-817D-C](#) [ORPC-817SB-TP-F](#) [PS2801C-4-F3-A/M](#) [PC817B](#)  
[TLP183\(YH-TPL,E\(T](#) [TLP183\(GRH-TPL,E\(T](#) [TLP183\(TPL,E\(T](#) [TLP291\(BL-TP,SE\(T](#) [TLP184\(V4GBTL,SE\(T](#) [TLP785\(BLL-TP6,F\(C](#)  
[TLP293\(GRH-TPL,E\(T](#) [TLP383\(D4GL-TR,E](#) [TLP185\(BLL-TL,SE\(T](#) [TLP2309\(TPL,E\(O](#) [TLP785\(BL-TP6,F\(C](#) [TLP185\(GRL-TL,SE\(T](#)  
[TLP785\(GR-TP6,F\(C](#) [TLP183\(BL-TPL,E\(T](#) [TLP2398\(TPL,E\(T](#) [TLP127GB-S](#) [LTV-354T-A\(UMW\)](#) [6N136S\(UMW\)](#) [PC817B-S](#) [FOC-817C](#)  
[EL1018](#) [IS121A](#) [IS2701-1A](#) [IS3H7A](#) [IS121D](#) [IS2701-1C](#) [IS121GB](#)