



# ORIENT

## Photo coupler

### Product Data Sheet

Part Number: OR-MOC304X/306X/308X

Customer: \_\_\_\_\_

Date: \_\_\_\_\_

**SHENZHEN ORIENT COMPONENTS CO., LTD**

Block A 3rd Floor No.4 Building, Tian'an Cyber Park, Huangge Rd, LongGang Dist, Shenzhen, GD

TEL: 0755-29681816

FAX: 0755-29681200

[www.orient-opto.com](http://www.orient-opto.com)

**1. Features**

- (1) High isolation voltage between input and output (Viso:5000 V rms )
- (2) 6pin zero-cross optoisolators triac driver output
- (3) High repetitive peak off-state voltage VDRM.
- (4) OR-MOC304X: Min. 400V;OR-MOC306X: Min. 600V;OR-MOC308X: Min. 800V
- (5) High critical rate of rise of off-state voltage( dV/dt : TYP. 800V /s )
- (6) Have Dual-in-line package;Wide lead spacing package and Surface mounting package .
- (7) Operating temperature -40 °C to +110 °C
- (8) Safety approval
  - UL approved (No.E323844)
  - VDE approved(No.40029733)
  - CQC approved (No.CQC19001231480)
- (9) In compliance with RoHS, REACH standards
- (10) MSL Level 1

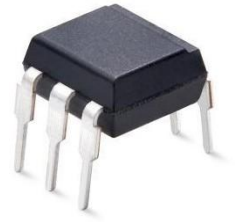

**2. Description**

The OR-MOC304X/OR-MOC306X/OR-MOC308X series of devices each consist of a GaAs infrared emitting diode optically coupled to a monolithic silicon zero voltage crossing photo triac.They are designed for use with a discrete power triac in the interface of logic systems , such as solid-state relays, industrial controls, motors, solenoids and consumer appliances.

**3. Application Range**

- (1)AC Motor Drives    (2)AC Motor Starters    (3)Static power switch    (4)Lighting Controls
- (5)Solenoid/Valve Controls                    (6)Solid State Relays    (7)Temperature Controls

**4. Absolute Maximum Ratings (Ta=25°C)**

Parameter		Symbol	Rateing	Unit	
Input	Forward Current	I <sub>F</sub>	50	mA	
	Junction Temperature	T <sub>J</sub>	125	°C	
	Reverse Voltage	V <sub>R</sub>	6	V	
	Power Dissipation	P	120	mW	
Output	Off-State Output Terminal Voltage	OR-MOC304X	400	V	
		OR-MOC306X	600		
		OR-MOC308X	800		
	Peak Repetitive Surge Current (PW=1ms, 120 pps)		I <sub>TSM</sub>	1	A
	On-State RMS Current		I <sub>T(RMS)</sub>	100	mA
	Junction Temperature		T <sub>J</sub>	125	°C
	Collector Power Dissipation		P <sub>C</sub>	150	mW
Total Power Dissipation		P <sub>tot</sub>	250	mW	
*Insulation Voltage		V <sub>iso</sub>	5000	V <sub>rms</sub>	
Working Temperature		T <sub>opr</sub>	-40 ~ + 110	°C	
Deposit Temperature		T <sub>stg</sub>	-55 ~ + 125		
*2 Soldering Temperature		T <sub>sol</sub>	260		

\*1 AC for 1 minute, R.H.= 40 ~ 60% R.H. In this test, pins 1, 2&3 are shorted together, and pins 4, 6 are shorted together.  
 \* 2 For 10 second

**5. Electrical Optical Characteristics at Ta=25°C**

Parameter		Symbol	Min	Typ.	Max	Unit	Condition							
Input	Forward Voltage	$V_F$	---	1.2	1.6	V	$I_F=20mA$							
	Reverse Current	$I_R$	---	---	5	$\mu A$	$V_R=6V$							
Output	1.Peak Blocking Current, Either Direction	$I_{DRM}$	---	---	500	nA	$V_{DRM} =$ Rated $V_{DRM}$							
	Peak On-State Voltage, Either Direction	$V_{TM}$	---	---	3.0	V	$I_{TM}=100mA$ Peak							
	2.Critical rate of Rise of Off-State Voltage	dv/dt	---	800	---	V/ $\mu s$	$V_{in}=240V_{rms}$							
Couple	3.Led Trigger Current, Current Required to Latch Output, Either Direction	OR-MOC3040 OR-MOC3060 OR-MOC3080	$I_{FT}$	---	---	mA	Main Terminal Voltage = 3V							
		OR-MOC3041 OR-MOC3061 OR-MOC3081						30	15					
		OR-MOC3042 OR-MOC3062 OR-MOC3082						10	5					
		OR-MOC3043 OR-MOC3063 OR-MOC3083						5	3					
		OR-MOC3044 OR-MOC3064 OR-MOC3084						3	---					
		Holding Current, Either Direction						$I_H$	---	400	---	$\mu A$		
		ZERO CROSSING						Inhibit Voltage	$V_{INH}$	---	5	20	Volts	$I_F = \text{Rated } I_{FT}$ , MT1-MT2 Voltage above which device will not trigger.
								Leakage in Inhibited State	$I_{DRM2}$	---	---	500	$\mu A$	$I_F = \text{Rated } I_{FT}$ , Rated $V_{DRM}$ , Off State



- \*1. Test voltage must be applied within dv/dt rating.  
 \*2. This is static dv/dt. Commutating dv/dt is a function of the load-driving thyristor(s) only.  
 \*3. All devices are guaranteed to trigger at an  $I_F$  value less than or equal to  $\max I_{FT}$ . Therefore, recommended operating  $I_F$  lies between  $\max I_{FT}$ , 30 mA for OR-MOC3040, OR-MOC3060 and OR-MOC3080, 15 mA for OR-MOC3041, OR-MOC3061 and OR-MOC3081, 10 mA for OR-MOC3042, OR-MOC3062 and OR-MOC3082, 5 mA for OR-MOC3043, OR-MOC3063 and OR-MOC3083, 3 mA for OR-MOC3044, OR-MOC3064 and OR-MOC3084, and absolute  $\max I_F$  (50mA).

## 6. Order Information

### Part Number

**OR-MOC304XV-W-Y**  
 or **OR-MOC306XV-W-Y**  
 or **OR-MOC308XV-W-Y**

### Note

- X = IFT Rank ( 0,1, 2, 3 or 4).  
 V = Lead form option (S, M or None).  
 W = Tape and reel option (TA,TA1 or none).  
 Y = 'V' code for VDE safety (This options is not necessary).

\* VDE Code can be selected.

Option	Description	Packing quantity
None	Standard DIP-6	66 units per tube
M	Wide lead bend (0.4 inch spacing)	66 units per tube
S(TA)	Surface mount lead form (low profile) + TA tape & reel option	1000 units per reel
S(TA1)	Surface mount lead form (low profile) + TA1 tape & reel option	1000 units per reel



### 8. Package Dimension

#### (1).MOC30XX

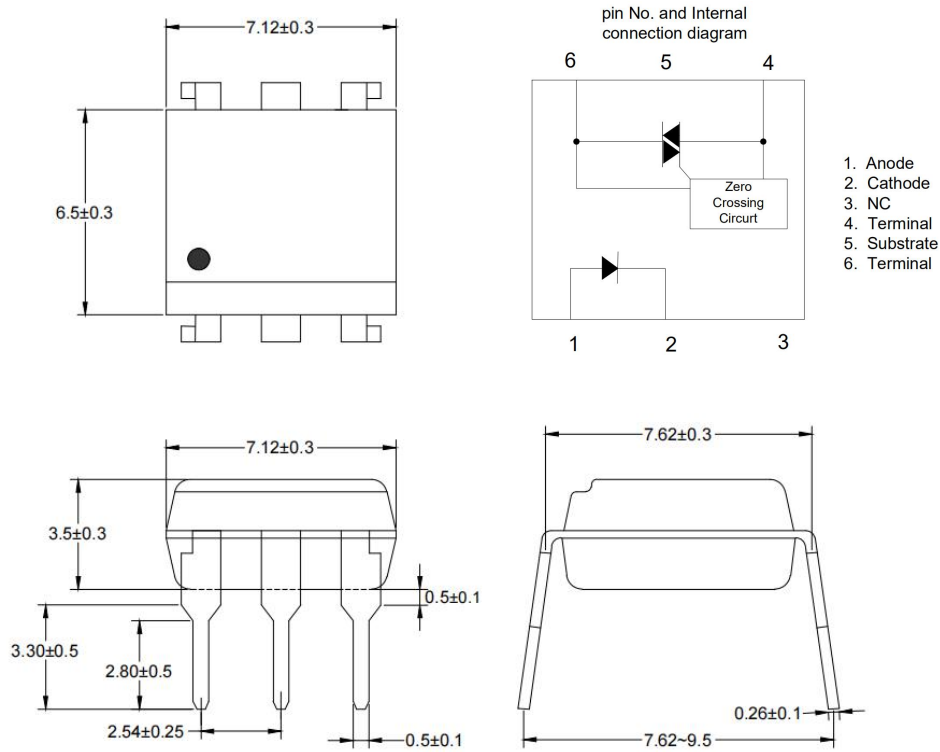

#### (2).MOC30XX M

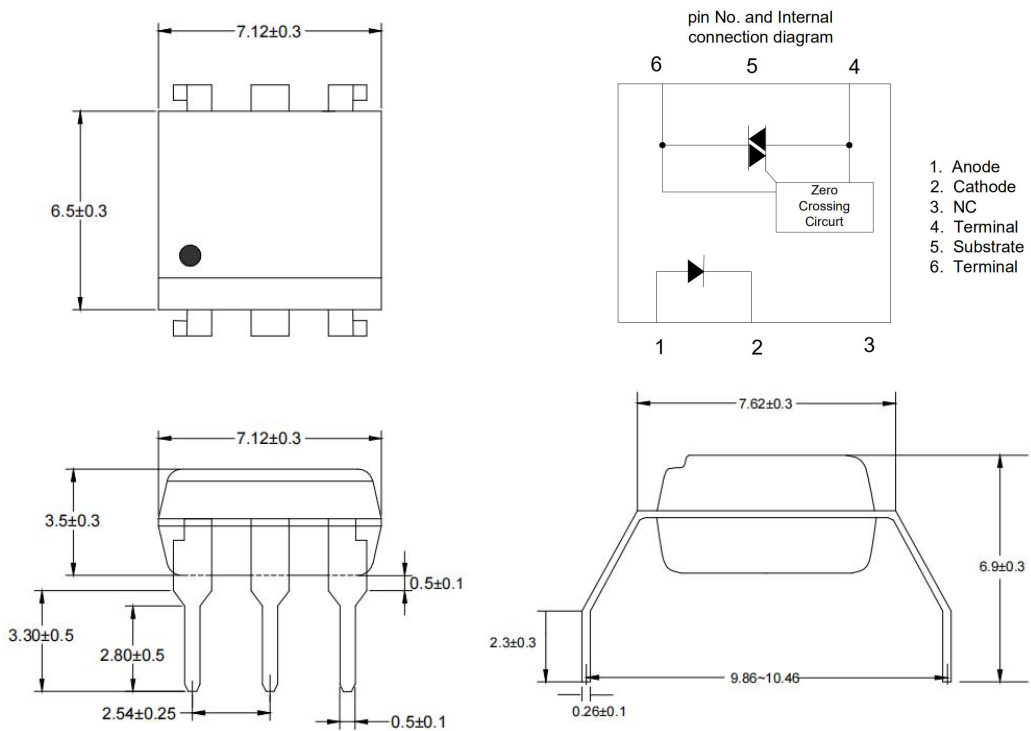

(3).MOC30XX S

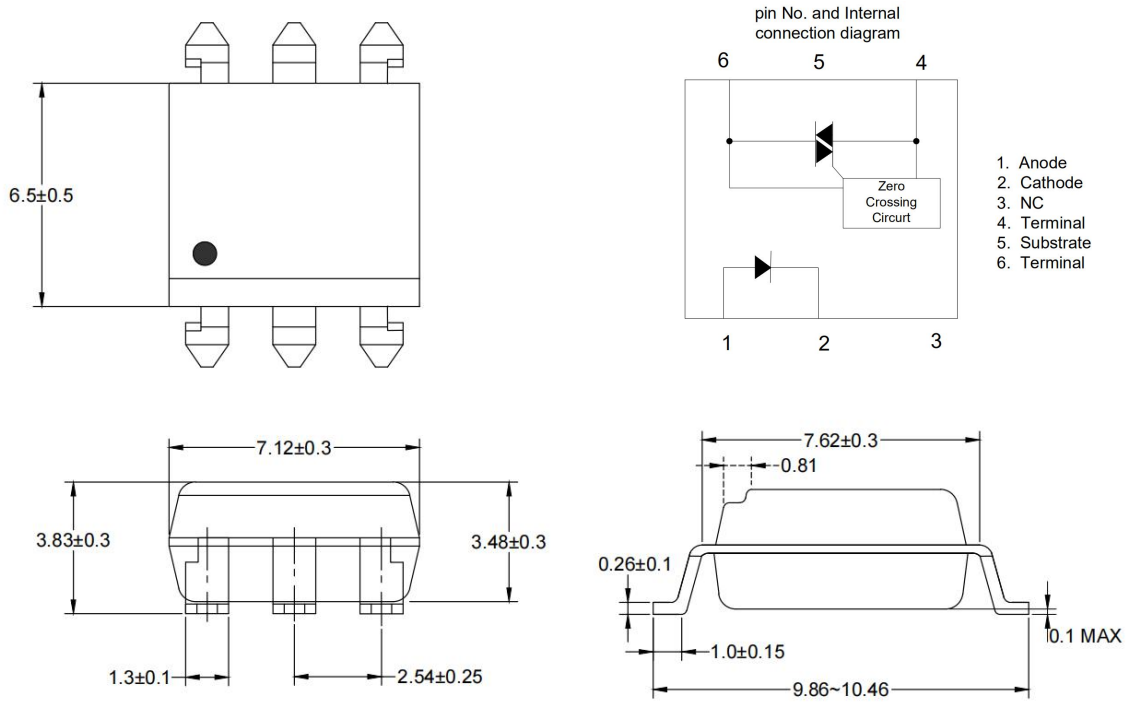

9. RRECOMMENDED FOOT PRINT PATTERNS (MOUNT PAD)

Unit: mm

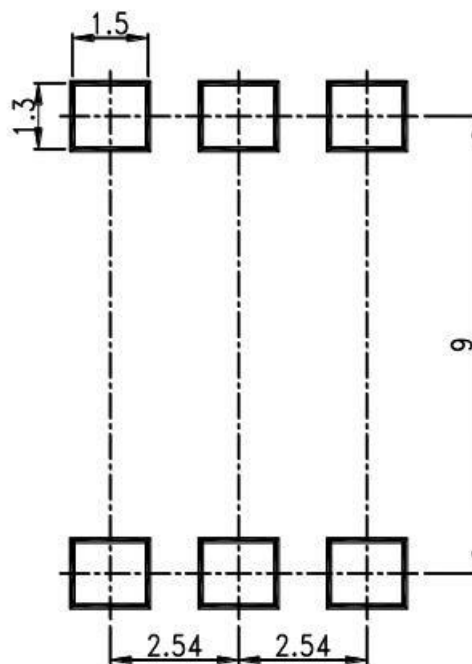

## 10. Taping Dimensions

### (1) .OR-MOC30XXS-TA

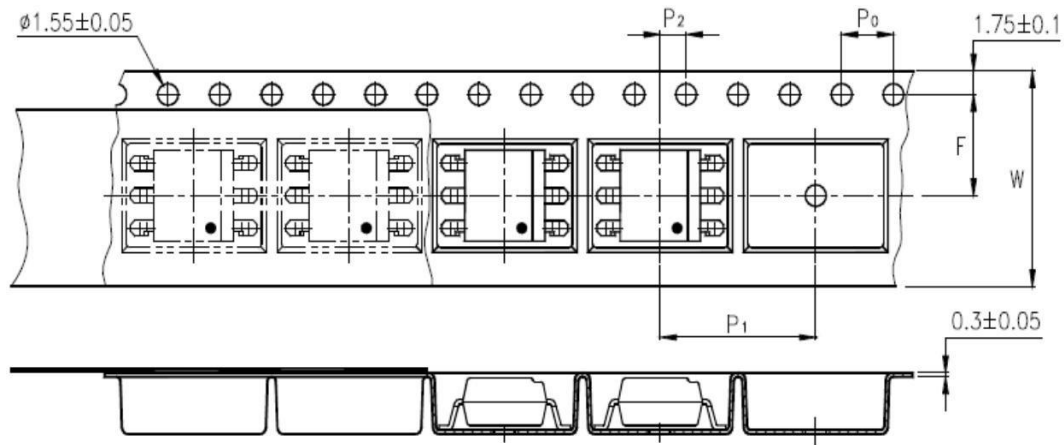

### (2) OR-MOC30XXS-TA1

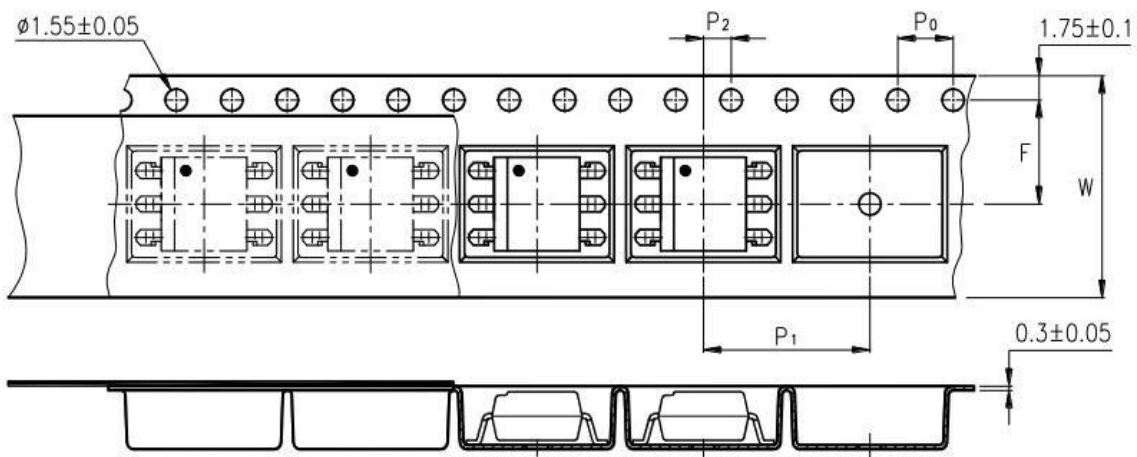

Description	Symbol	Dimension in mm (inch)
Tape wide	W	16±0.3 (0.63)
Pitch of sprocket holes	P <sub>0</sub>	4±0.1 (0.15)
Distance of compartment	F	7.5±0.1 (0.295)
	P <sub>2</sub>	2±0.1 (0.079)
Distance of compartment to compartment	P <sub>1</sub>	12±0.1 (0.472)

Package Type	TA/TA1
Quantities(pcs)	1000



### 11. Package Dimension

DIP Type

Packing Information	
Packing type	Tube
Qty per Tube	66pcs
Small box (Inner) Dimension	525*128*60mm
Large box (Outer) Dimension	545*290*335mm
The Amount per Inner Box	3,300pcs
The Amount per Outer Box	33,000pcs



SOP Type

Packing Information	
Packing type	Reel type
Tape Width	16mm
Qty per Reel	1,000pcs
Small box (inner) Dimension	345*345*58.5mm
Large box (Outer) Dimension	620x360x360mm
Max qty per small box	2,000pcs
Max qty per large box	20,000pcs

### (2)Packing Label Sample



**Material Code** : 120PCXXXXXX  
|||||  
**P/N** : OR-XXXXXX  
|||||  
**Lot No.** : XXXXXX-XXXXX-TX-X  
|||||  
**D/C** : XXXX  
|||||  
**Qty** : XXXX PCS  
|||||

内箱码

外箱码

“XXXXXXXXXXXXXXXXXX” (一体机序列码)

**Made in China**

**Note:**

1. Material Code :Product ID.
2. P/N :Contents with "Order Information" in the specification.
3. Lot No. :Product data.
4. D/C :Product weeks.
5. Quantity :Packaging quantity.

## 12. Temperature Profile Of Soldering

(1).IR Reflow soldering (JEDEC-STD-020C compliant)

One time soldering reflow is recommended within the condition of temperature and time profile shown below. Do not solder more than three times.

Profile item	Conditions
Preheat - Temperature Min (T Smin ) - Temperature Max (T Smax ) - Time (min to max) (ts)	150°C 200°C 90±30 sec
Soldering zone - Temperature (TL ) - Time (t L )	217°C 60 sec
Peak Temperature	260°C
Peak Temperature time	20 sec
Ramp-up rate	3°C / sec max.
Ramp-down rate from peak temperature	3~6°C / sec
Reflow times	≤3

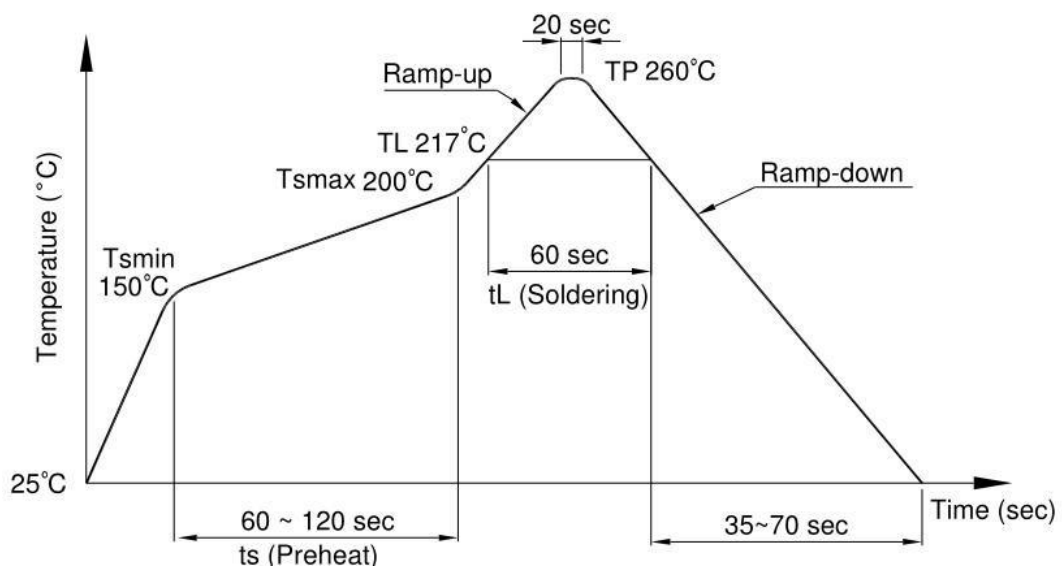

**(3) .Wave soldering (JEDEC22A111 compliant)**

One time soldering is recommended within the condition of temperature.

Temperature	260+0/-5°C
Time	10 sec
Preheat temperature	5 to 140°C
Preheat time	30 to 80 sec

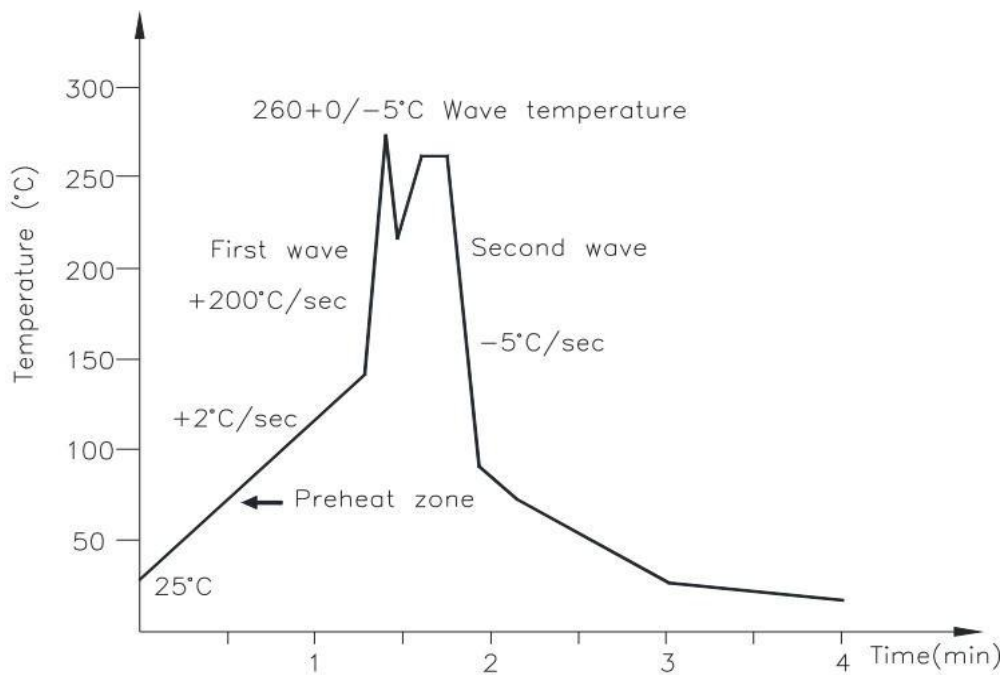

**(3).Hand soldering by soldering iron**

Allow single lead soldering in every single process. One time soldering is recommended.

Temperature	380+0/-5°C
Time	3 sec max

### 13. CHARACTERISTICS CURVES (TYPICAL PERFORMANCE)

Fig.1 Forward Current vs. Ambient Temperature

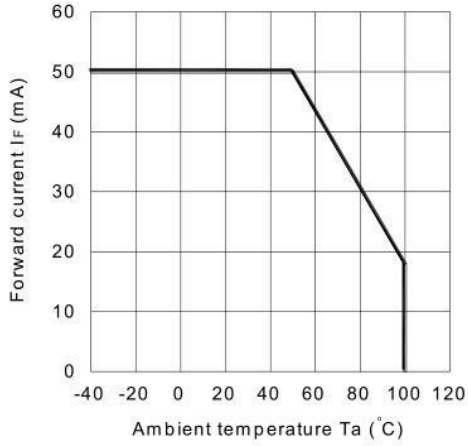

Fig.2 On-state Current vs. Ambient Temperature

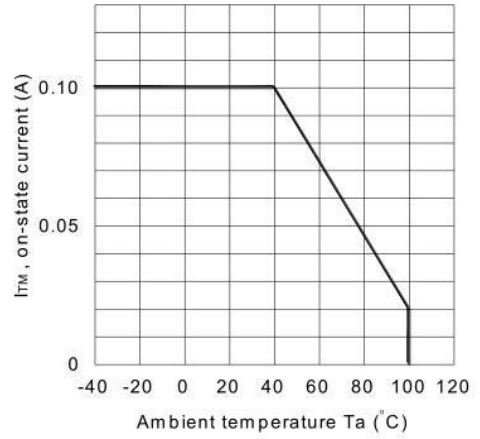

Fig.3 Minimum Trigger Current vs. Ambient Temperature

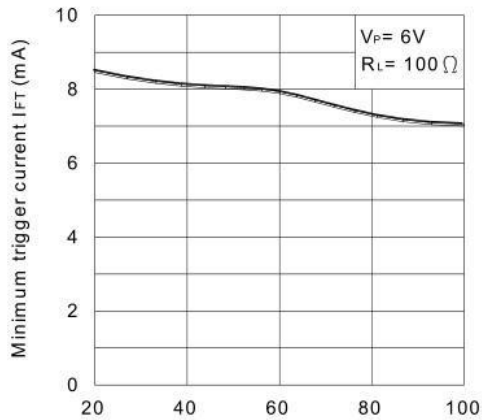

Fig.4 Forward Current vs. Forward Voltage

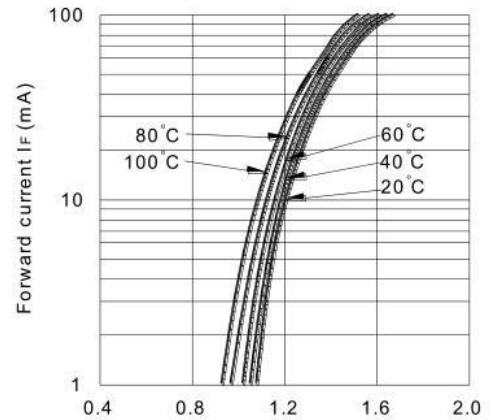

Fig.5 On-state Voltage vs. Ambient Temperature

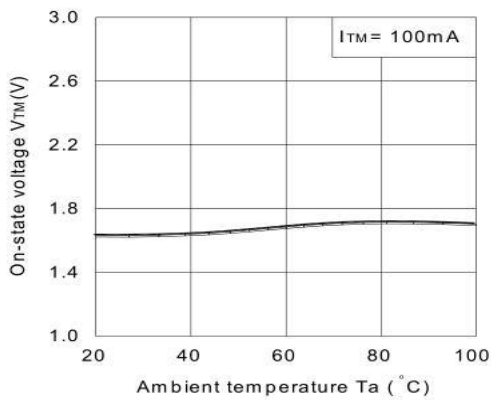

Fig.6 Holding Current vs. Ambient Temperature

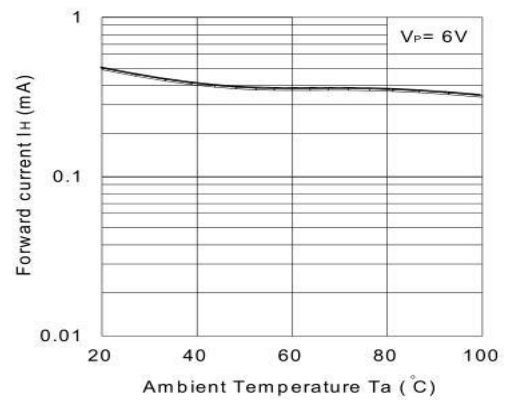

Fig.7 Repetitive Peak Off-state Current vs. Temperature

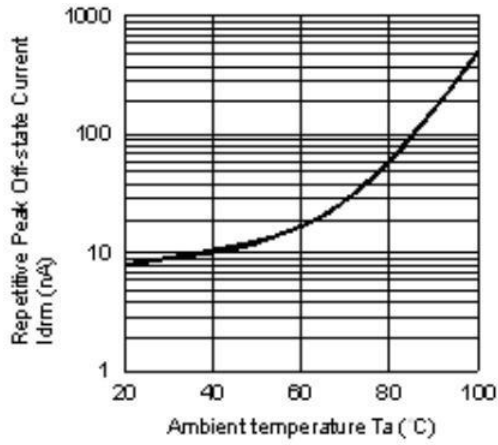
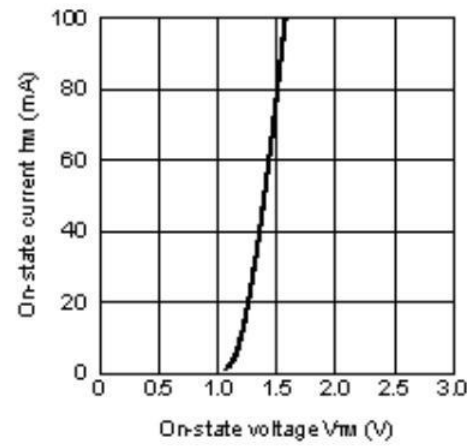
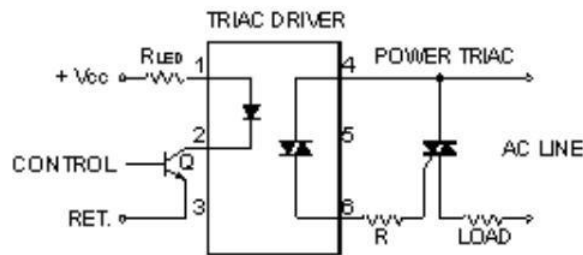

Fig.8 On-state Current vs. On-state Voltage



Basic Driver Circuit



## X-ON Electronics

Largest Supplier of Electrical and Electronic Components

*Click to view similar products for [Triac & SCR Output Optocouplers](#) category:*

*Click to view products by [Orient](#) manufacturer:*

Other Similar products are found below :

[MOC3063S-TA](#) [IL410-X019T](#) [ILD207-X001T](#) [ILD615-1X007T](#) [VO4254H](#) [WPPCT-N1066A](#) [WPPCT-N1566A](#) [WPPCT-Z546D](#) [523170E](#)  
[VO2223A-X007T](#) [WPPCT-Z546A](#) [WPPCT-Z1046D](#) [WPPCT-Z1046A](#) [WPPCT-N566D](#) [WPPCT-N566A](#) [WPPCT-N1566D](#)  
[FODM3053V\\_NF098](#) [TLP3042SCF](#) [VO4258D](#) [VO4256D](#) [VO4158H-X017T](#) [IL4116-X009T](#) [MOC3071SM](#) [IL4116-X007](#) [VO0601-X001T](#)  
[OR-MOC3061](#) [MOC3020M](#) [MOC3041M](#) [MOC3062M](#) [MOC3063M](#) [MOC3081M](#) [MOC3051M](#) [MOC3023M](#) [ELM440A\(TA\)-VG](#)  
[MOC3083SM](#) [MOC3022SM](#) [MOC3021SM](#) [OR-MOC3062](#) [OR-MOC3061S-TA1](#) [EL3053S\(TA\)-V](#) [ELM3052](#) [ELM3054\(TA\)-V](#)  
[ELM3083\(TA\)-V](#) [TLP265J\(E\(T](#) [MOC3020XSM](#) [MOC3021X](#) [MOC3021XSM](#) [MOC3022X](#) [MOC3023SR2M](#) [MOC3041SM](#)