



深圳市奥伦德科技股份有限公司
Shenzhen Orient Technology Co., Ltd

产品规格书

Specification Sheet

品 名(P/N): 光电耦合器 Photocoupler

客户名称(Customer): _____

本厂型号(Mfg P/N): OR-306X

日 期(Date): _____



● 特点 (Features)

1. 绝缘电压: (Isolation voltage between input and output) $V_{iso} \geq 5,000V_{rms}$
2. 6脚零交叉可控硅光电隔离器 (6pin DIP zero-cross optoisolators triac driver output)
3. 符合欧盟 REACH 标准 (Compliance with EU REACH)
4. 产品符合 RoHS 要求 (The product itself will remain within RoHS compliant version)
5. 运行温度范围: (Operating temperature) $-40^{\circ}C$ to $+110^{\circ}C$

● 说明 (description)

描述该系列器件包含一个红外发光二极管和光电探测器。不含卤素和 Sb_2O_3 。

● 应用范围 (Application Range)

- 交流电动机驱动 (AC Motor Drives)
- 照明控制 (Lighting Controls)
- 固态继电器 (Solid State Relays)
- 交流电机启动器 (AC Motor Starters)
- 电磁阀控制 (Solenoid/Valve Controls)
- 温度控制器 (Temperature Controls)

● 最大绝对额定值 (常温 $T=25^{\circ}C$) Max Absolute rated Value (Normal Temperature= $25^{\circ}C$)

参数 Parameter		符号 Symbol	典型值 Rated Value	单位 Unit
输入 Input	正向电流 (Forward Current)	I_F	50	mA
	结温 (Junction Temperature)	T_J	125	$^{\circ}C$
	反向电压 (Reverse Voltage)	V_R	6	V
	功率耗损 (Power Dissipation)	P	100	mW
输出 Output	断态重复峰值电压 (Off-State Output Terminal Voltage)	V_{DRM}	600	V
	峰值重复浪涌电流 (Peak Repetitive Surge Current (PW=1ms, 120 pps))	I_{TSM}	1	A
	结温 (Junction Temperature)	T_J	125	$^{\circ}C$
	集电极功率耗损 (Collector Power Dissipation)	P_C	150	mW
总功率消耗 (Total Power Dissipation)		P_{tot}	250	mW
*1 绝缘电压 (Insulation Voltage)		V_{iso}	5000	Vrms
工作温度 (Working Temperature)		T_{opr}	-40 ~ +110	$^{\circ}C$
存贮温度 (Deposit Temperature)		T_{stg}	-55 ~ +110	
*2 焊锡温度 (Soldering Temperature)		T_{sol}	260	

*1. 交流测试, 时间 1 分钟, R.H. =40~60% AC Test, 1 minute, humidity = 40~60%

如下是绝缘测试的方法. Insulation test method as below:

- (1) 将产品的两端短路。 Short circuit both terminals of photocoupler
- (2) 测试绝缘电压时无电流通过。 No Current when testing insulation voltage
- (3) 测试时加正弦波形电压。 Adding sine wave voltage when testing

*2. 锡焊时间为 10 秒 soldering time is 10 seconds



● 光电特性(常温 T=25°C) (Opto-electronic Characteristics)

参数 Parameter		符号 Symbol	条件 Condition	最小 Min	典型值 Typ.*	最大 Max	单位 Unit	
输入 (Input)	正向电压 (Forward Voltage)	V_F	$I_F=20\text{mA}$	---	1.2	1.6	V	
	逆向电流(Reverse Current)	I_R	$V_R=6\text{V}$	---	0.05	10	μA	
输出 (Output)	1.峰值阻断电流, 任一方向 (Peak Blocking Current, Either Direction)	I_{DRM}	$V_{\text{DRM}} = 600\text{V}$	---	---	500	nA	
	峰值状态电压, 任一方向 (Peak On-State Voltage, Either Direction)	V_{TM}	$I_{\text{TM}}=100\text{mA Peak}$	---	---	3.0	V	
	2.断态电压临界上升率 (Critical rate of Rise of Off-State Voltage)	dv/dt	$V_{\text{in}}=240\text{Vrms}$	1000	---	---	V/us	
组合 Couple	3.LED 触发电流, 锁存输出所需的电流, 任一方向 (Led Trigger Current, Current Required to Latch Output, Either Direction)	3061	I_{FT}	Main Terminal Voltage = 3V	---	---	15	mA
		3062			---	---	10	
		3063			---	---	5	
	Holding Current, Either Direction		I_{H}		---	400	---	μA
ZERO CROSSING	抑制电压 (Inhibit Voltage)	V_{INH}	$I_{\text{F}} = \text{Rated } I_{\text{FT}}, \text{ MT1-MT2}$ Voltage above which device will not trigger.	---	5	20	Volts	
	泄漏处于抑制状态 (Leakage in Inhibited State)	I_{DRM2}	$I_{\text{F}} = \text{Rated } I_{\text{FT}}, \text{ Rated } V_{\text{DRM}}, \text{ Off State}$	---	---	500	μA	

*1. Test voltage must be applied within dv/dt rating.

*2. This is static dv/dt. Commutating dv/dt is a function of the load-driving thyristor(s) only.

*3. All devices are guaranteed to trigger at an I_{F} value less than or equal to max I_{FT} .

Therefore, recommended operating I_{F} lies between max I_{FT} , 15 mA for 3061, 10 mA for 3062, 5 mA for 3063, and absolute max I_{F} (50mA).

● 命名规则 (Naming Rule)

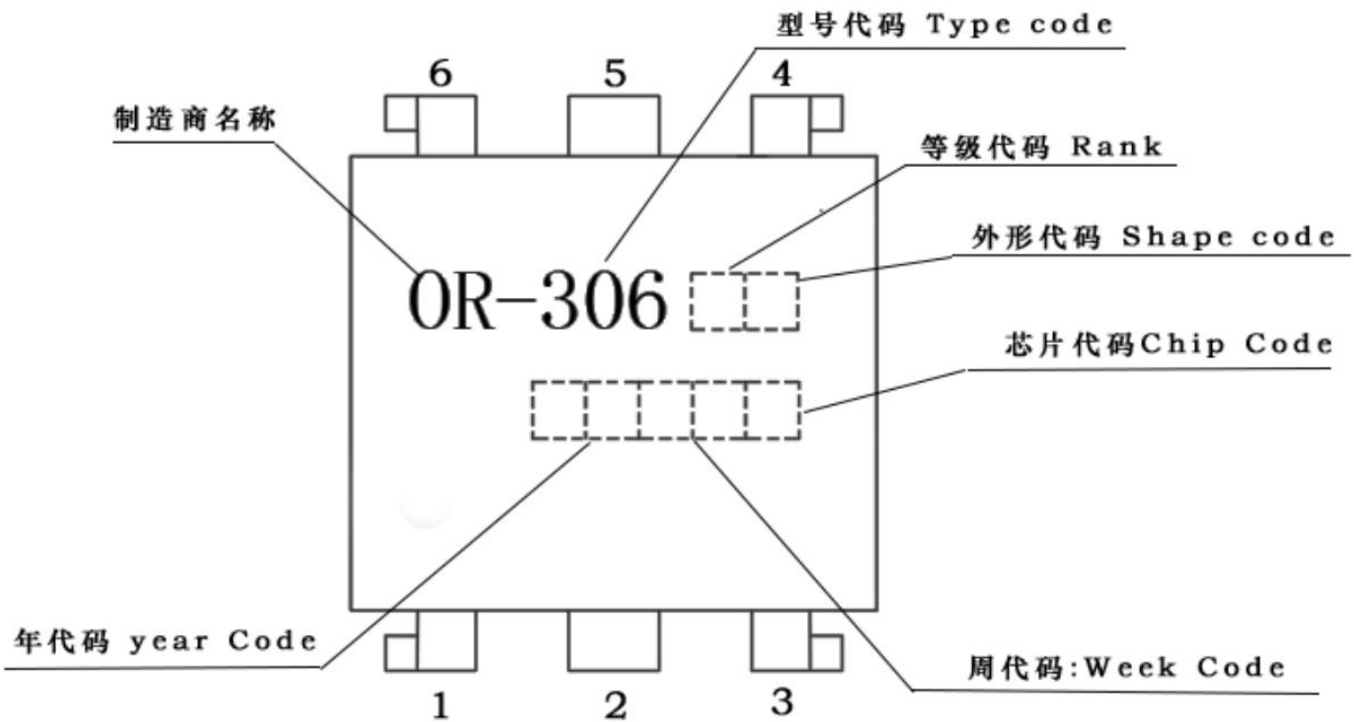

注:

- 1、制造商名称: OR代表制造商 Shenzhen Orient Components Co., Ltd.
- 2、型号代码 Type Code: 306 代表光耦产品型号
- 3、等级代码 Rank: 有1、2、3共3种形式, X=1代表3061; X=2代表3062; X=3代表3063。
- 4、外形代码Shape code: 空白--代表外形OR-306X; M--代表OR-306XM; S--代表OR-306XS,具体请看外形尺寸。
- 5、年代码:Year Code: 例如: F8 或C8, 其中F表铁支架/C表铜支架, 8代表2018年、依此类推。
- 6、周代码:Week Code: 01代表第一周、02代表第二周、依此类推
- 7、单位: mm

● 外形尺寸 (Outer Dimension)

1. OR-306X

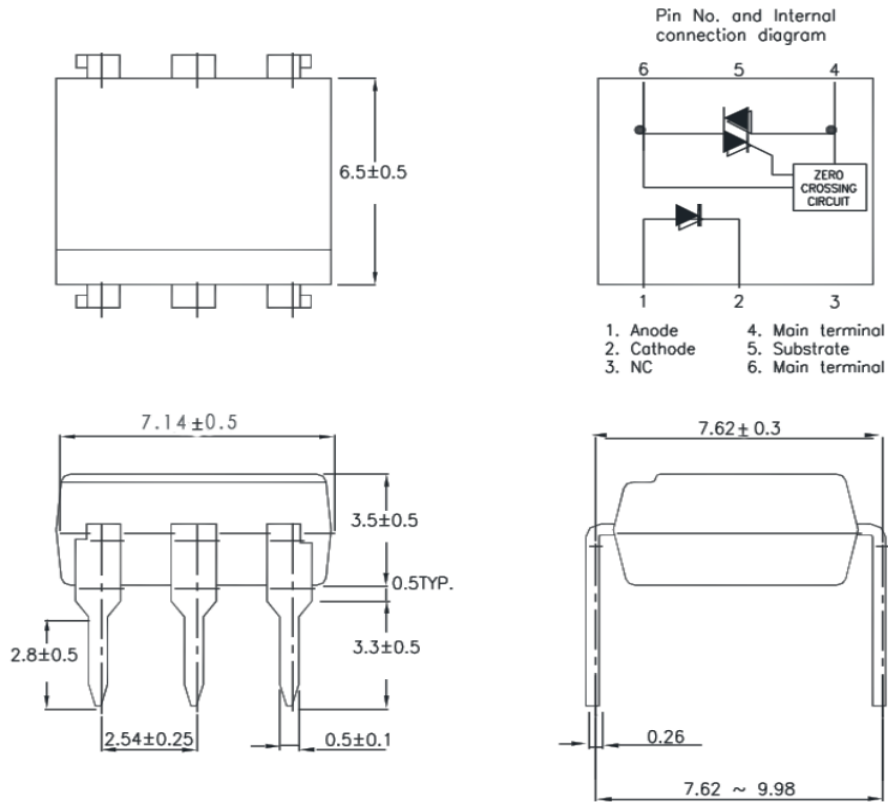

2. OR-306XM

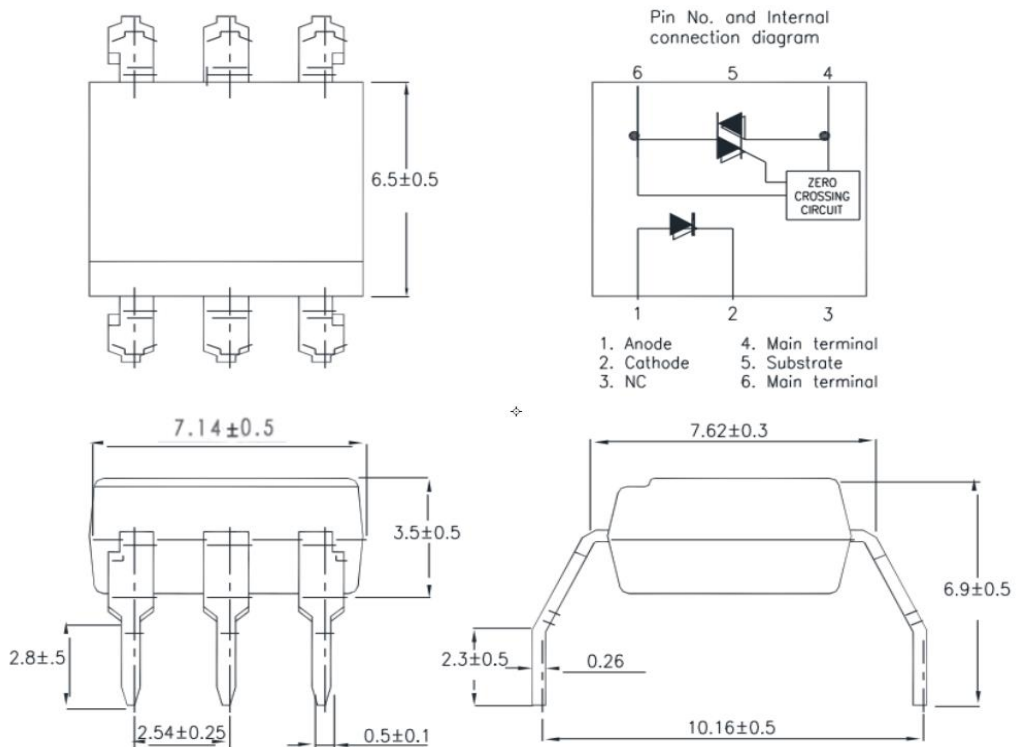

3. OR-306XS

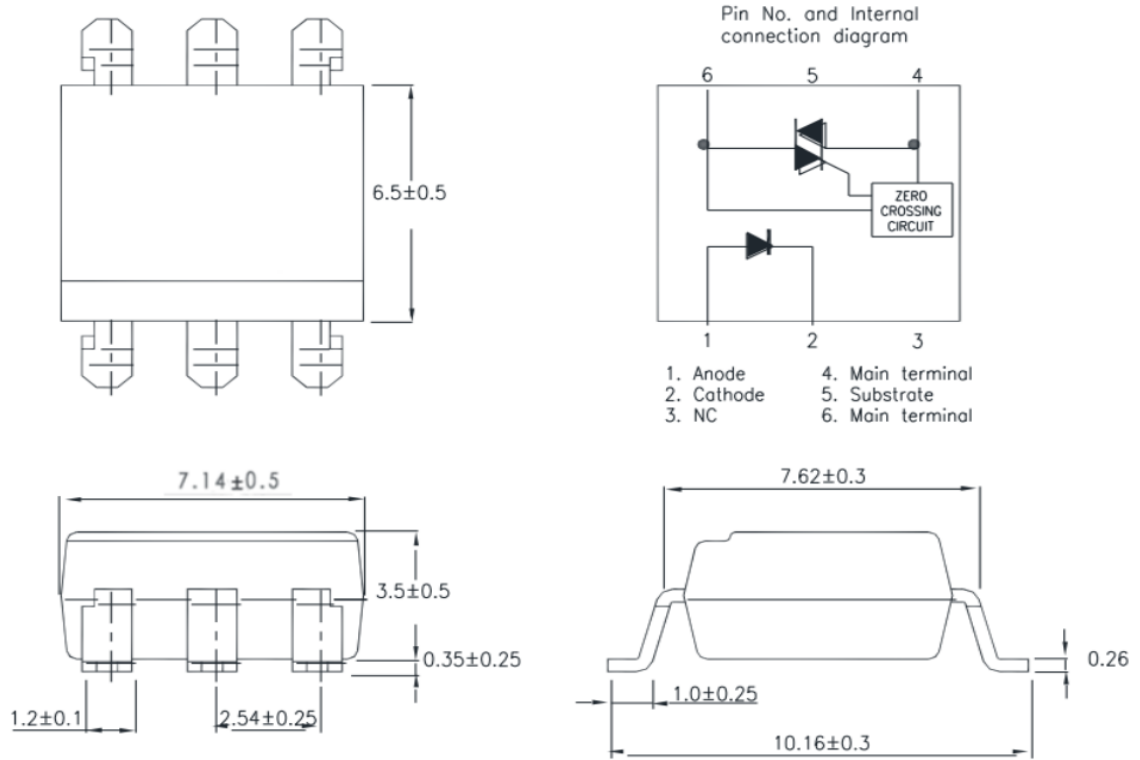

● 编带尺寸 (Taping Dimensions)

1. OR-306XS-TA

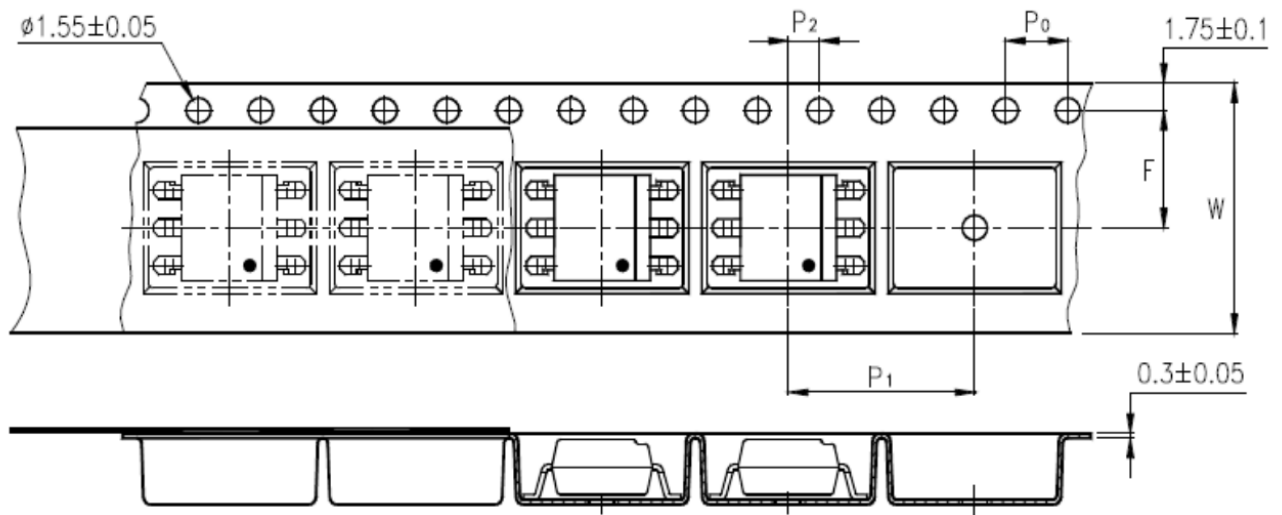

2. OR-306XS-TA1

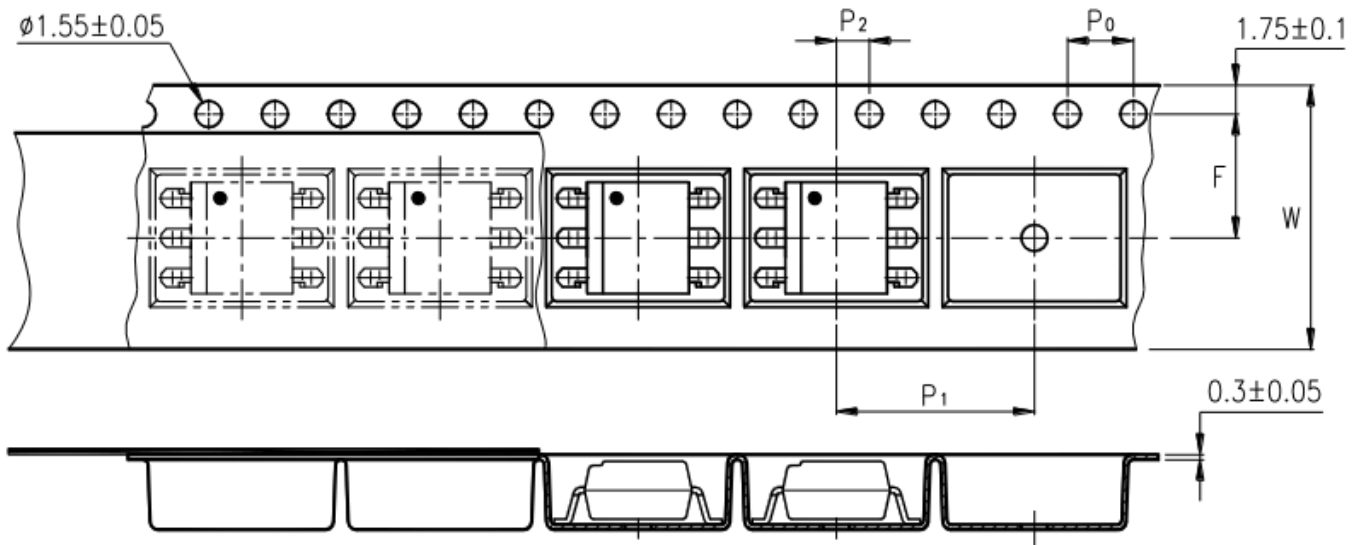

Description	Symbol	Dimension in mm (inch)
Tape wide	W	16±0.3 (0.63)
Pitch of sprocket holes	P ₀	4±0.1 (0.15)
Distance of compartment	F	7.5±0.1 (0.295)
	P ₂	2±0.1 (0.079)
Distance of compartment to compartment	P ₁	12±0.1 (0.472)

封装类型	306XS series (TA/TA1)
数量 (个)	1000

● 焊接温度曲线 (Temperature Profile Of Soldering)

1. 红外回流焊 (jedec-std-020c 兼容) (IR Reflow soldering (JEDEC-STD-020C compliant))

注意：一次焊接回流建议在温度和时间配置文件如下所示的条件下。不要焊接超过三次。

配置项	条件
预热 (Preheat)	
-最低温度 (T _{Smin})	150°C
-最高温度 (T _{Smax})	200°C
-时间 (最小到最大 (TS))	90 ± 30 sec
焊接区 (Soldering zone)	
-温度 (T _L)	217°C
-时间 (t _L)	60 sec
峰值温度 (Peak Temperature)	260°C
爬升率 (Ramp-up rate)	3°C / sec max.
下降率 (3°C / sec max.)	3~6°C / sec

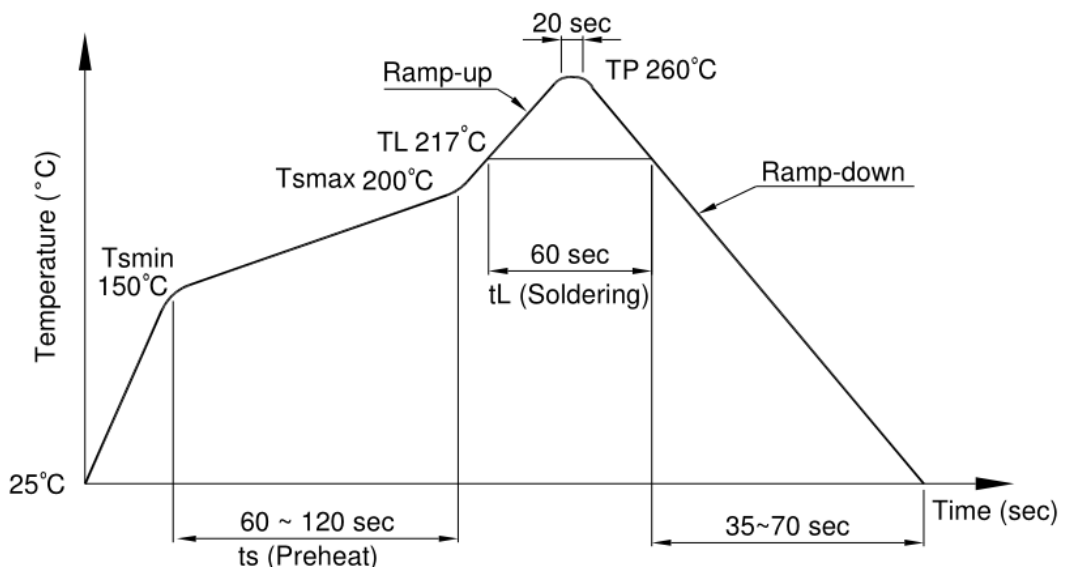



2.波峰焊接 (jedec22a111 兼容) (Wave soldering (JEDEC22A111 compliant))

建议在温度条件下一致性焊接。

温度 (Temperature)	260+0/-5°C
时间 (Time)	10 sec
预热温度 (Preheat temperature)	5 to 140°C
预热时间 (Preheat time)	30 to 80 sec

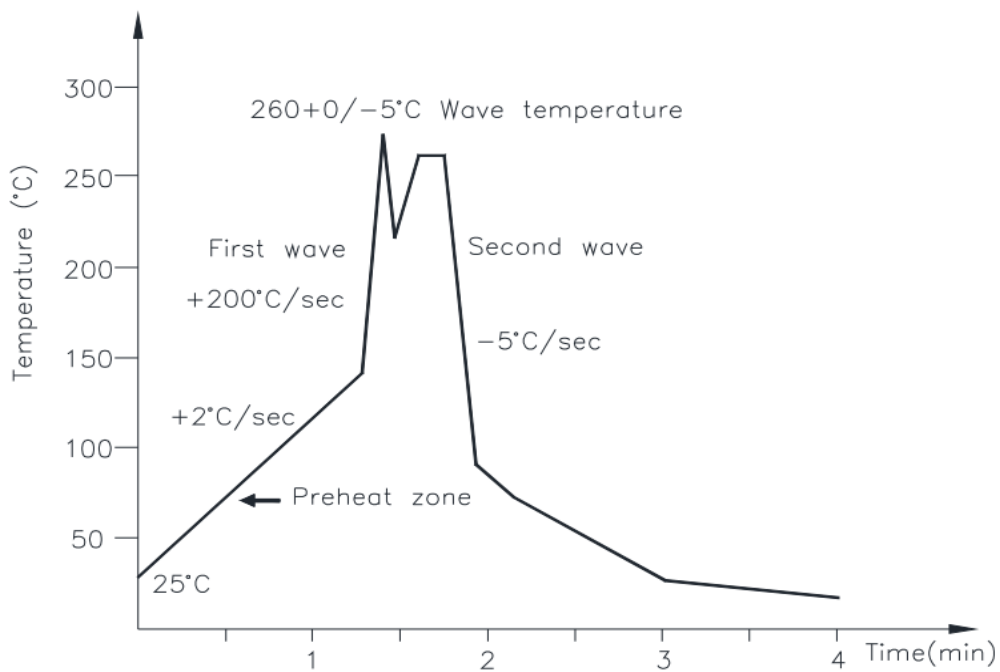

3.电烙铁手工焊接 (Hand soldering by soldering iron)

允许单铅焊接在每一个过程中, 建议一次性焊接。

温度 (Temperature)	380+0/-5°C
时间 (Time)	3 sec max

● 推荐的焊盘 (Temperature Profile Of Soldering)

Unit: mm

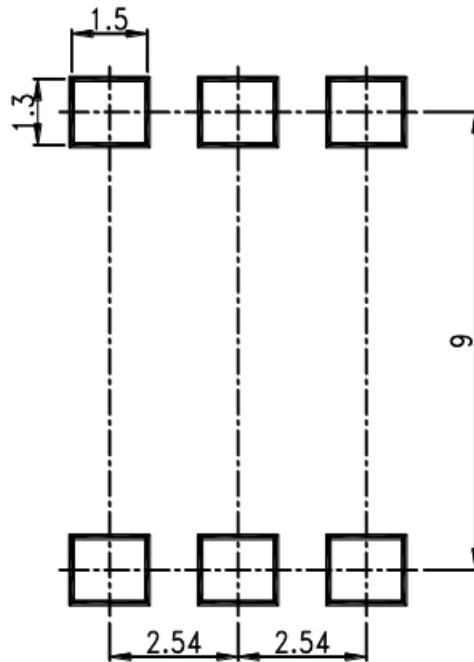



● 特性曲线 Characteristics Curve

Fig.1 Forward Current vs. Ambient Temperature

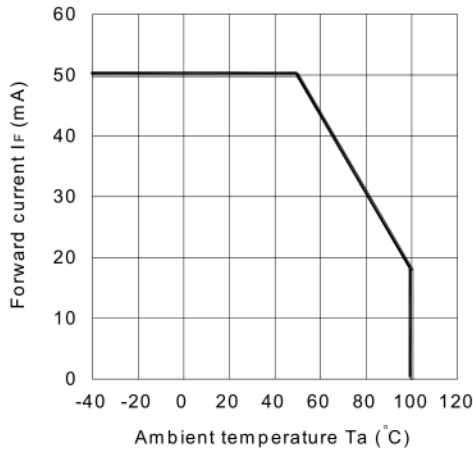

Fig.2 On-state Current vs. Ambient Temperature

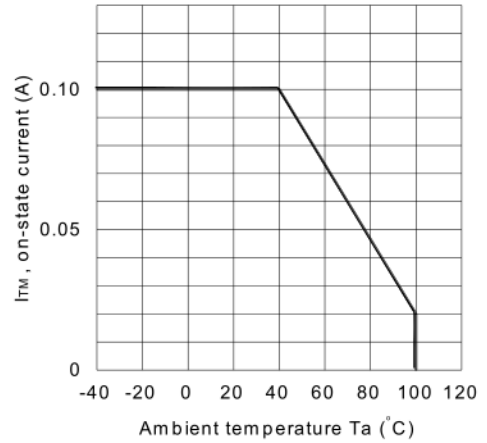

Fig.3 Minimum Trigger Current vs. Ambient Temperature

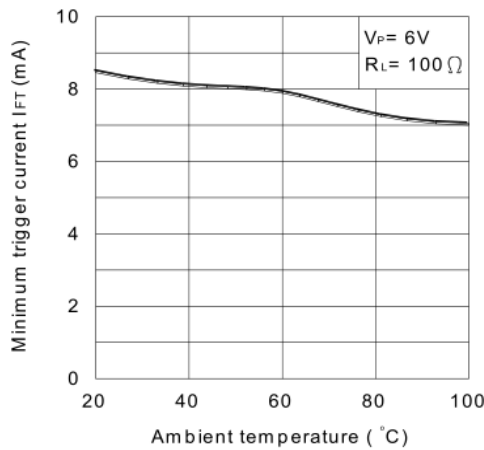

Fig.4 Forward Current vs. Forward Voltage

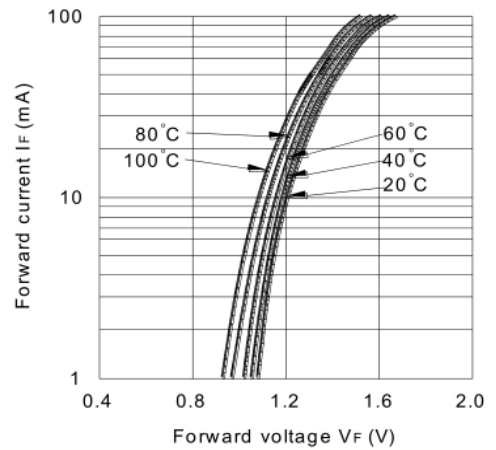

Fig.5 On-state Voltage vs. Ambient Temperature

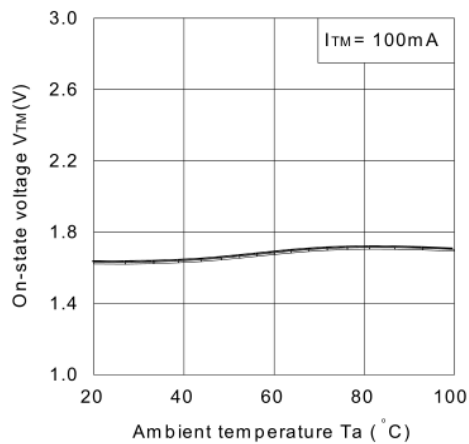

Fig.6 Holding Current vs. Ambient Temperature

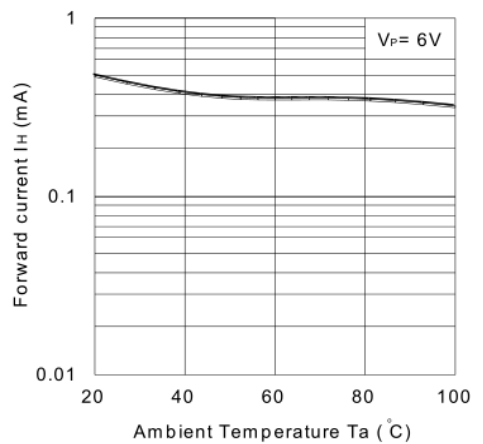

Fig.7 Repetitive Peak Off-state Current vs. Temperature

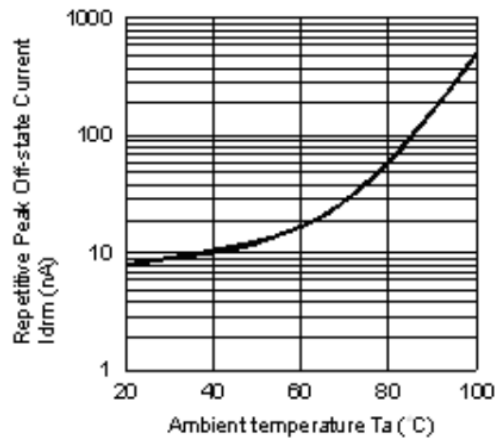
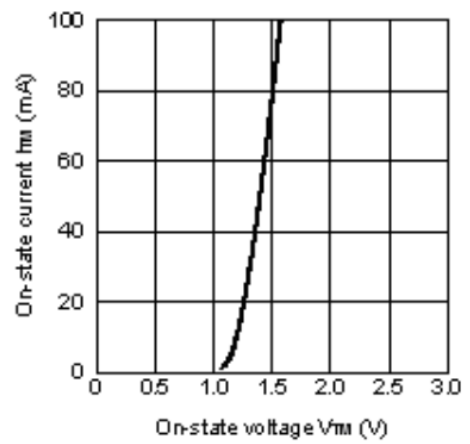
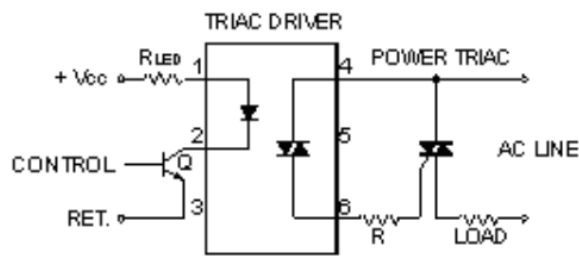

Fig.8 On-state Current vs. On-state Voltage



Basic Driver Circuit



X-ON Electronics

Largest Supplier of Electrical and Electronic Components

Click to view similar products for [High Speed Optocouplers](#) category:

Click to view products by [Orient](#) manufacturer:

Other Similar products are found below :

[6N136F](#) [PS8502L2-AX](#) [ACNW261L-000E](#) [ACPL-344JT-000E](#) [ACPL-K49T-500E](#) [ACPL-K74T-000E](#) [ACPL-K75T-000E](#) [ACPL-W21L-560E](#) [ACPL-K44T-500E](#) [TLP187\(TPL,E\(T](#) [TLP2601\(TP1,F\)](#) [610737H](#) [6N137A-X001](#) [6N137A-X017T](#) [6N139-X007T](#) [HCPL2630M](#) [HCPL2731SM](#) [TLP555\(F\)](#) [HCPL2630SM](#) [PS2841-4A-F3-AX](#) [PS9817A-1-F3-AX](#) [PS9821-2-F3-AX](#) [ORPC-817D](#) [ORPC-817M/C](#) [ORPC-817M/B](#) [PT17-51C/L129\(BIN2\)](#) [TLP521-4GBSM](#) [UMW817C](#) [6N137S1\(TA\)](#) [TLP521GB](#) [TLP521GB-S](#) [PS2501](#) [PS2501-S](#) [TLP785GB](#) [TLP785GB-S](#) [LTV-214-G](#) [TLP2766A\(E](#) [TLP2766A\(LF4,E](#) [LCR-0202](#) [EL814S1\(TA\)-V](#) [PC817X4NSZ2B](#) [CYPC817](#) [OR-MOC3023](#) [TLP267J\(TPL,E\(T](#) [TLP109\(TPL,E\(O](#) [EL2514S1\(TU\)\(CLW\)-G](#) [EL816S2\(C\)\(TU\)-F](#) [TLP281-4](#) [MOC3023M](#) [ACPL-K49T-060E](#)