



深圳市奥伦德科技股份有限公司
Shenzhen Orient Technology Co., Ltd

产品规格书

Specification Sheet

品 名(P/N): 光电耦合器 Photocoupler

客户名称(Customer): _____

本厂型号(Mfg P/N): ORPC-814

日 期(Date): _____

深圳市奥伦德科技股份有限公司 (股票代码: 832016)
Shenzhen Orient Tech Ltd. Co (Ticker Symbol: 832016)

Web: www.orient-opto.com

地址: 广东深圳龙岗区黄阁路天安数码城 4 栋 3 楼 A 座 518172

Add: Block A 3rd Floor No. 4 Building Tian'an Cyber Park Huangge Rd, LongGang Dist, Shenzhen, GD, 518172

版本版次: A/3



● **特点:**

1. 交流输入
2. 电流转换比(CTR: 最小.20%工作条件 $I_F = \pm 1\text{mA}$, $V_{CE} = 5\text{V}$)
3. 绝缘电压: ($V_{ISO} = 5,000\text{Vrms}$)
4. 工作温度: $-55^\circ\text{C} \sim 110^\circ\text{C}$
5. 高集极与射极崩溃电压: $V_{CE} = 80\text{V}$
6. 响应时间 (t_r : TYP. $4\mu\text{s}$ 工作条件 $V_{CE} = 2\text{V}$, $I_C = 2\text{mA}$, $R_L = 100\ \Omega$)
7. UL approved(No.E323844)
VDE approved(No.40029733)
CQC approved(No.CQC09001029446 CQC13001086898)
CE approved(No.AC/0431008)
国网 approved(No.SGCM013420170152)



● **说明**

1. ORPC-814 系列光耦合器的组成是: 由二个 GaAs 的发射管和一个 NPN 的晶体管组成
2. ORPC-814 的 BIN 脚宽是 2.54mm

● **应用范围:**

1. 交流通信设备
2. 可编程控制器
3. 电话连结口
4. 未知极性的直流感应器

● **最大绝对额定值 (常温=25°C)**

参数		符号	额定值	单位
输入	顺向电流	I_F	± 50	mA
	功耗率(大约在 100°C 下)	PD	70	mW
输出	集极与射极电压	V_{CEO}	35	V
	射极与集极电压	V_{ECO}	6	
	消耗功率(大约在 100°C 下)	PC	150	mW
总功率消耗		P_{tot}	200	mW
*1 绝缘电压		Viso	5,000	Vrms
工作温度		T_{opr}	-50 to + 110	°C
存贮温度		T_{stg}	-55 to + 125	
*2 焊锡温度		T_{sol}	260	

*1. 交流测试, 时间 1 分钟, 湿度 = 40~60%

如下是绝缘测试的方法.

- (1) 将产品的两端短路。
- (2) 测试绝缘电压时无电流通过。
- (3) 测试时加正弦波形电压。

*2. 锡焊时间为 10 秒



● 光电特性(常温=25℃)

参数		符号	条件	最小.	中.	最大	单位
输入	顺向电压	VF	IF=±20mA	---	1.2	1.4	V
	集极电容	Ct	V=0, f=1KHz	---	30	250	pF
输出	集极至射极电流	ICEO	VCE=20V, IF=0	---	---	100	nA
	集极与射极崩溃电压	BVCEO	IC=0.1mA IF=0	35	---	---	V
	射极与集极崩溃电压	BVECO	IE=0.1mA IF=0	6	---	---	V
传输特性	集极电流	Ic	IF=±1mA VCE=5V	0.2	---	3	mA
	*1 电流转换比 (ORPC-814)	CTR		20	---	300	%
	*1 电流转换比(ORPC-814A)			50	---	150	%
				100	---	300	%
	集极与射极饱和电压	VCE(sat)	IF=±20mA IC= 1mA	---	0.1	0.2	V
	绝缘阻抗	Riso	DC500V 40~60%R.H.	5×10 ¹⁰	1×10 ¹¹	---	Ω
	电容量	Cf	V=0, f=1MHz	---	0.6	1	pF
	转换频率	fc	VCE=5V, IC=2mA RL=100Ω, -3dB	---	80	---	kHz
	上升时间	tr	VCE=2V, IC=2mA	---	4	18	μs
下降时间	tf	RL=100Ω	---	3	18	μs	

*1 电流转换比= $I_c / I_f \times 100\%$

说明:

1. 工作条件: IF=±1mA, VCE=5V, Ta=25℃.



● 电流传输比的等级分类 (RANK TABLE OF CURRENT TRANSFER RATIO CTR)

OR-814	CTR Rank	最小 (Min)	最大 (Max)	测试条件 (Condition)
	A	50	150	$I_F = \pm 1\text{mA}$
	B	100	300	$V_{CE} = 5\text{V}$
	No mark	20	300	$T_a = 25^\circ\text{C}$

● 命名规则 (Naming Rule And)

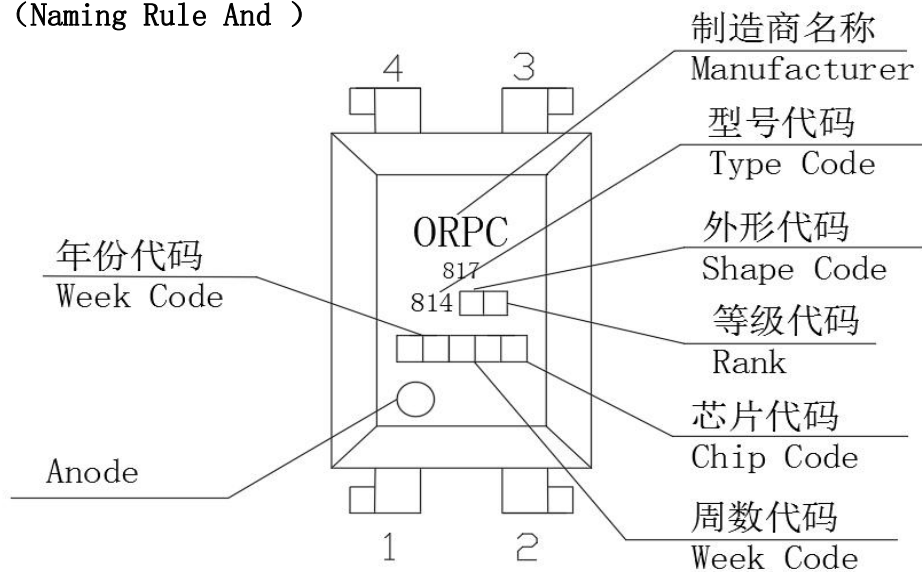

1、制造商名称: ORPC 代表制造商 Shenzhen Orient Components Co., Ltd.

2、型号代码 Type Code: 814 代表产品型号

3、外形代码 Shape Code:

空白--代表ORPC-814;

M--代表ORPC-814M;

S--代表ORPC-814S。

4、年代码 year Code: 例如: F7 或C7, 其中F表铁支架/C表铜支架, 7代表2017年、依此类推。

5、芯片代码 Chip Code

6、周数代码 Week Code: 01代表第一周、02代表第二周、依此类推

7、Anode: 阳极

● 外形尺寸 (Outer Dimension) (单位: mm)

1. ORPC-814

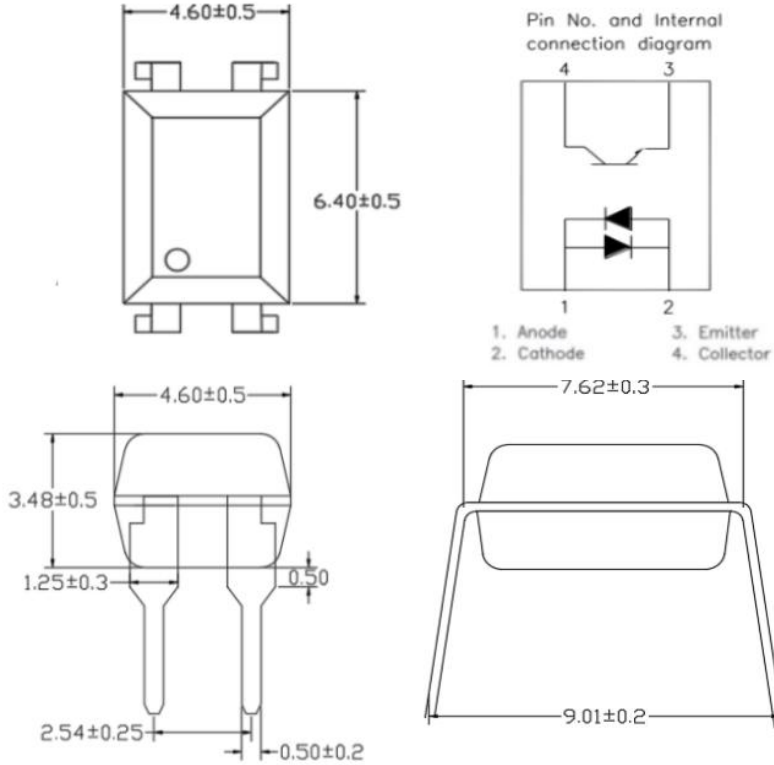

2. ORPC-814M

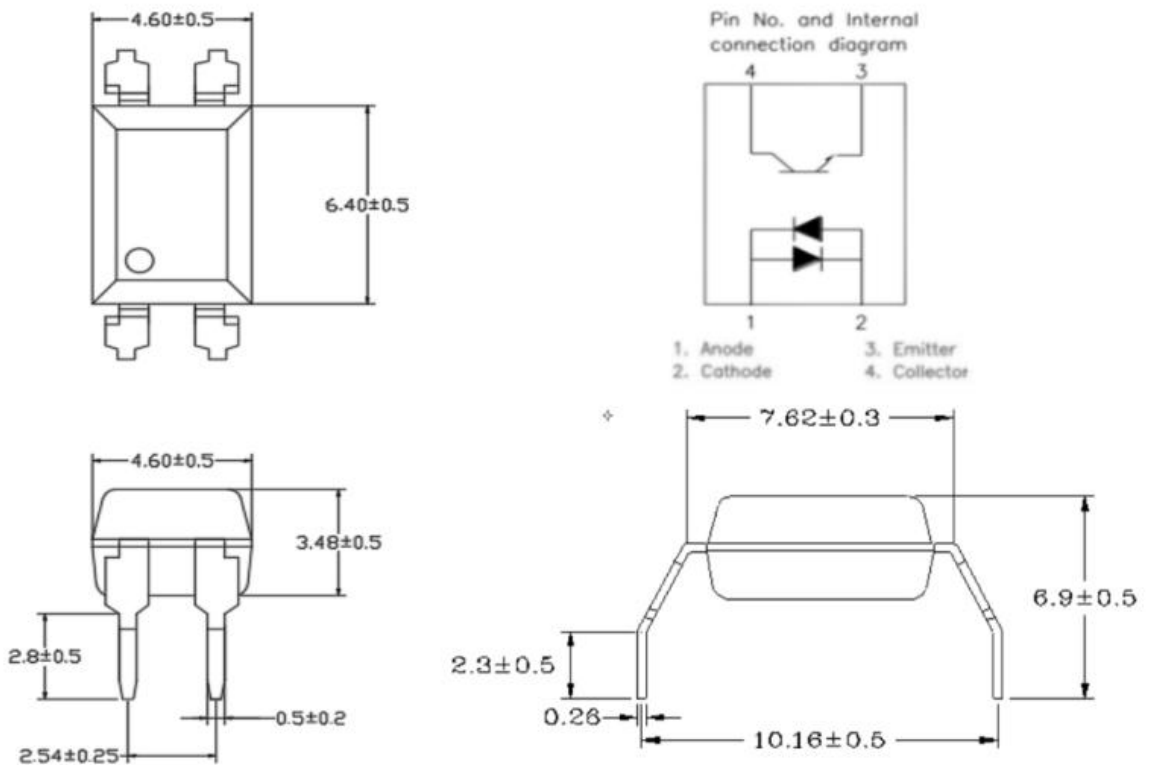

3.ORPC-814S

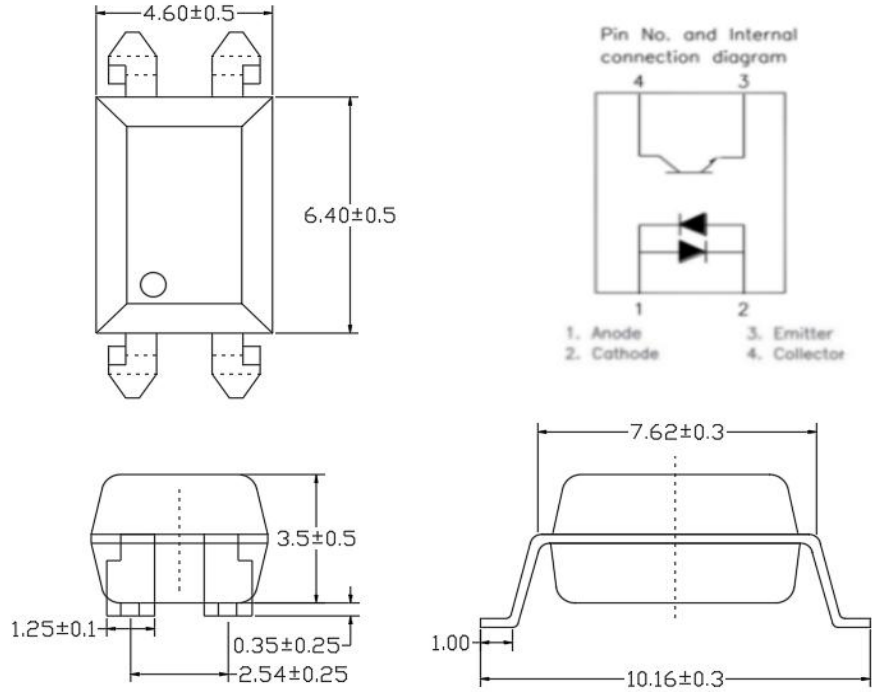

● 编带尺寸 (Taping Dimensions)

1. ORPC-814S-TA

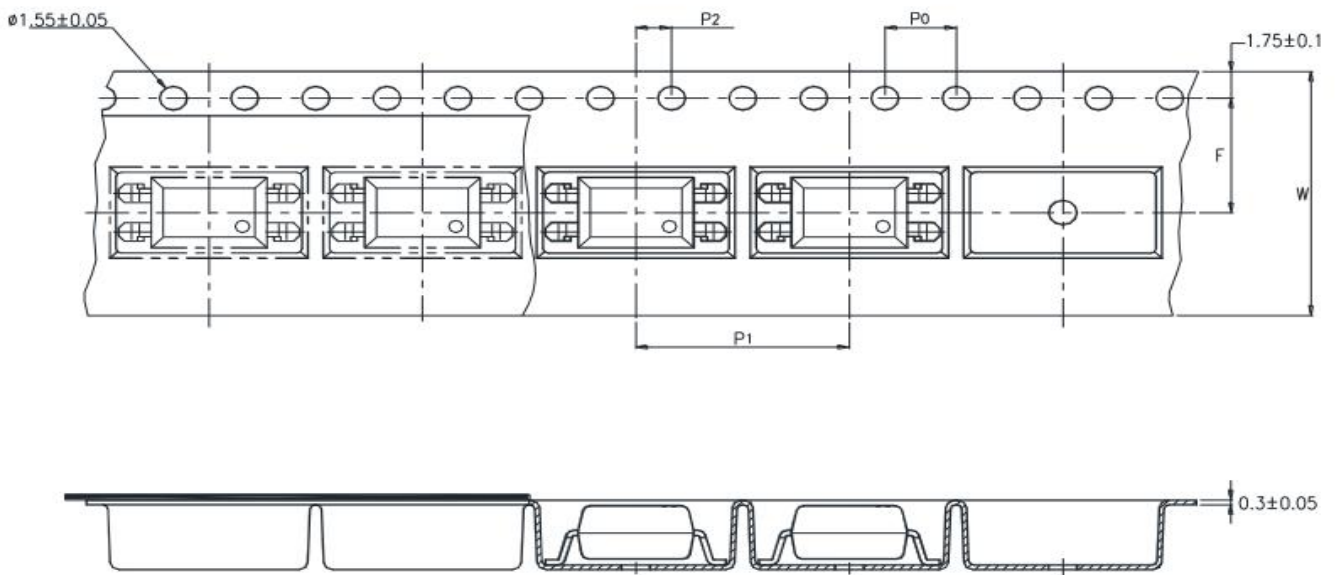

2. ORPC-814S-TA1

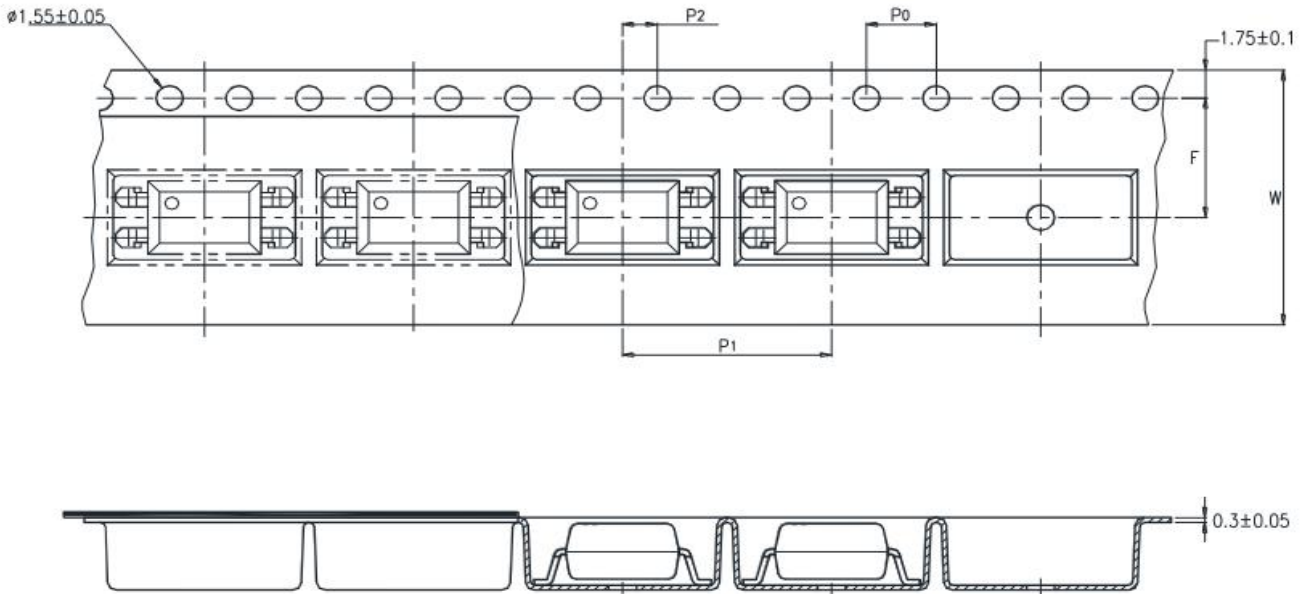

类型	符号	尺寸:毫米(英寸)
带宽	W	16 ± 0.3 (.63)
孔距	P0	4 ± 0.3 (.63)
孔距	F	7.5 ± 0.1 (.295)
	P2	2 ± 0.1 (.079)
间隔	P1	12 ± 0.1 (.472)

封装类型	TA/TA1
数量(个)	1000

3. ORPC-814S-TP

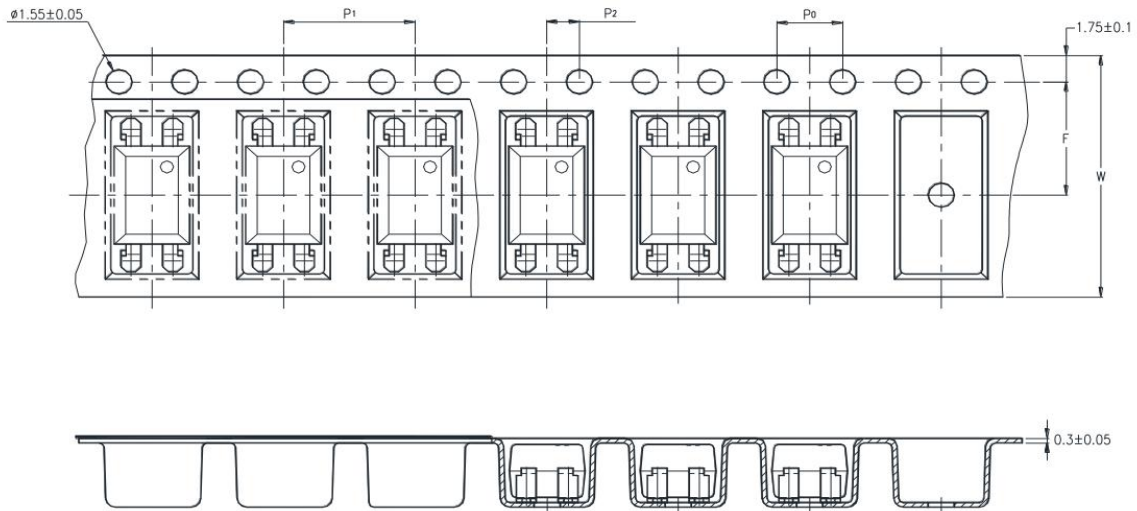

类型	符号	尺寸:毫米(英寸)
带宽	W	16 ± 0.3 (.63)
孔距	P0	4 ± 0.3 (.63)
孔距	F	7.5 ± 0.1 (.295)
	P2	2 ± 0.1 (.079)
间隔	P1	8 ± 0.1 (.315)

封装类型	TP
数量(个)	2000

● 推荐的焊盘尺寸 (Recommended Foot Print Patterns (Mount Pad))



单位: mm

● 焊接温度曲线图 (Temperature Profile Of Soldering)

1. 红外回流焊 (jedec-std-020c 兼容) (IR Reflow soldering (JEDEC-STD-020C compliant))

注意：一次焊接回流建议在温度和时间配置文件如下所示的条件下。不要焊接超过三次。

配置项	条件
预热 (Preheat)	
-最低温度 (T _{Smin})	150°C
-最高温度 (T _{Smax})	200°C
-时间 (最小到最大 (T _S))	90±30 sec
焊接区 (Soldering zone)	
-温度 (T _L)	217°C
-时间 (t _L)	60 sec
峰值温度 (Peak Temperature)	260°C
爬升率 (Ramp-up rate)	3°C / sec max.
下降率 (Ramp-down rate)	3~6°C / sec

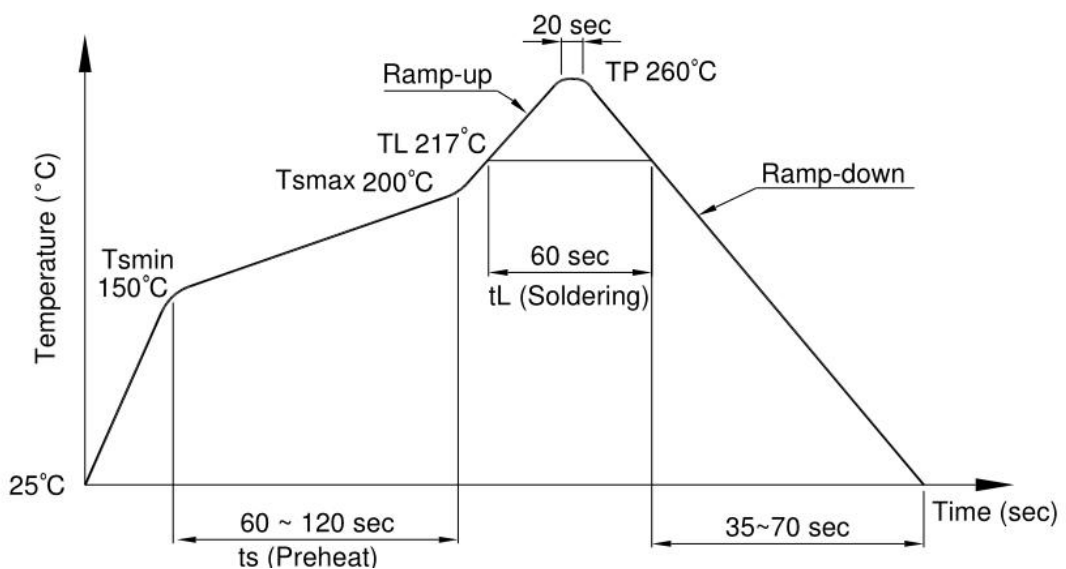



2.波峰焊接 (jedec22a111 兼容) (Wave soldering (JEDEC22A111 compliant))

建议在温度条件下一一次性焊接。

温度 (Temperature)	260+0/-5°C
时间 (Time)	10 sec
预热温度 (Preheat temperature)	5 to 140°C
预热时间 (Preheat time)	30 to 80 sec

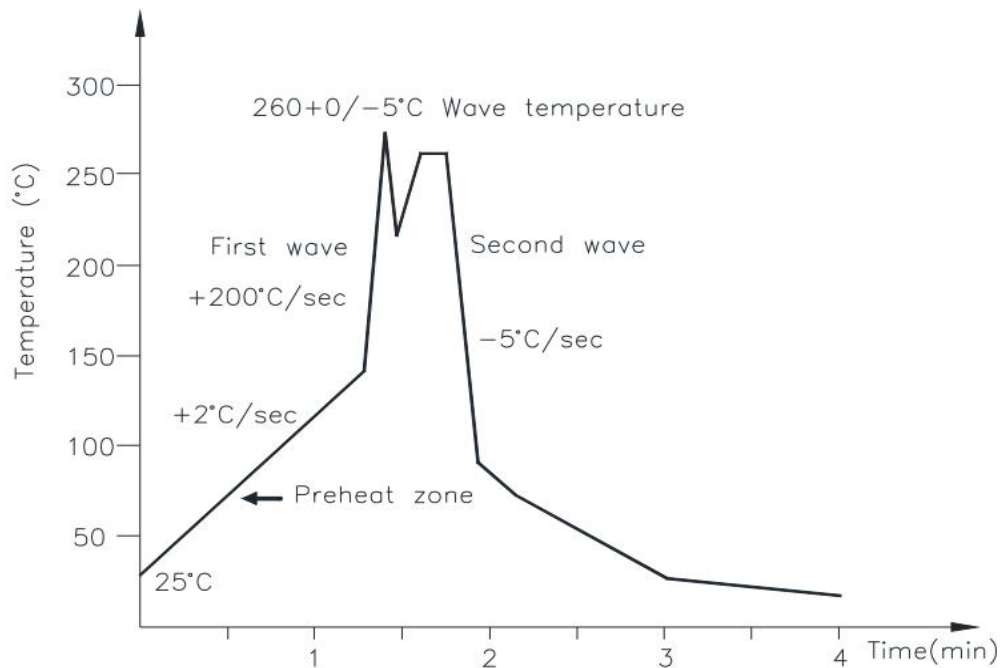

3.电烙铁手工焊接 (Hand soldering by soldering iron)

允许单铅焊接在每一个过程中,建议一次性焊接。

温度 (Temperature)	380+0/-5°C
时间 (Time)	3 sec max



● 特性曲线

Fig.1 Forward Current vs. Ambient Temperature

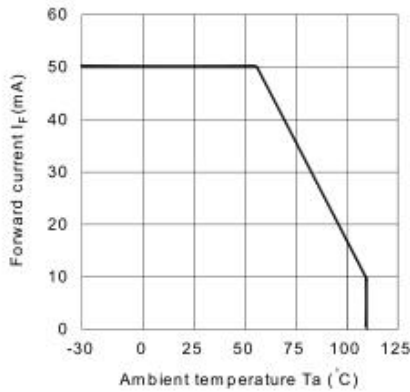

Fig.2 Collector Power Dissipation vs. Ambient Temperature

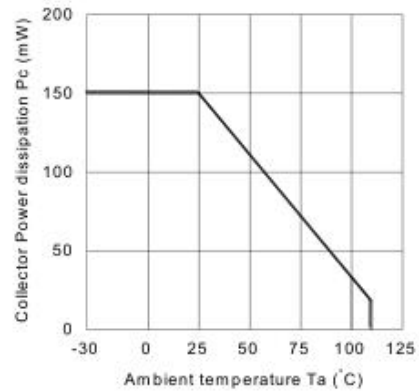

Fig.3 Collector-emitter Saturation Voltage vs. Forward Current

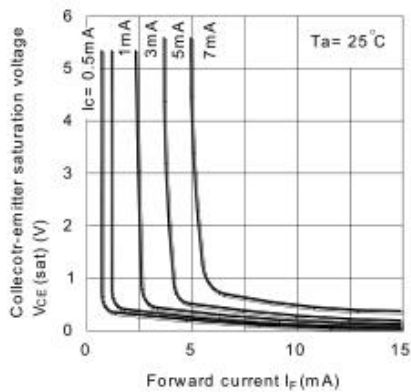

Fig.4 Forward Current vs. Forward Voltage

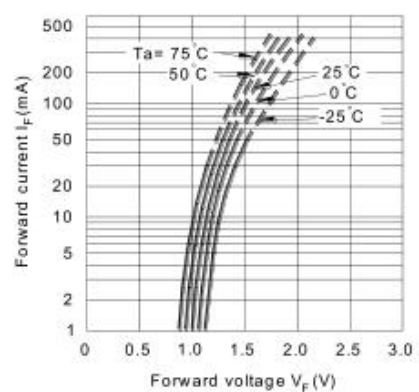

Fig.5 Current Transfer Ratio vs. Forward Current

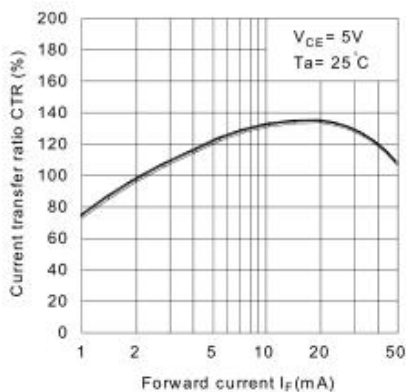
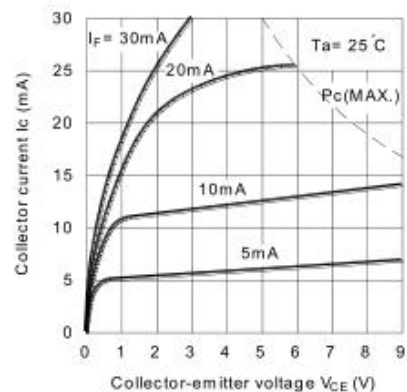

Fig.6 Collector Current vs. Collector-emitter Voltage





● 特性曲线

Fig.7 Relative Current Transfer Ratio vs. Ambient Temperature

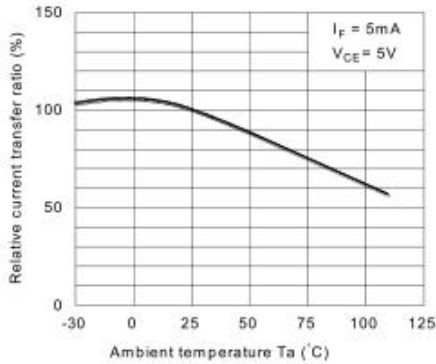

Fig.8 Collector-emitter Saturation Voltage vs. Ambient Temperature

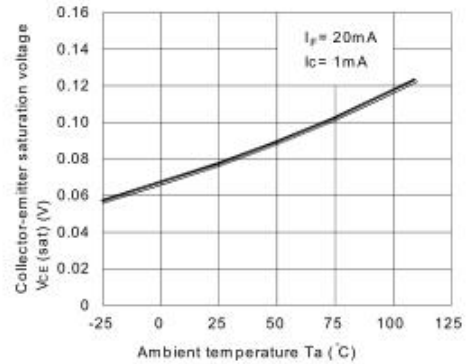

Fig.9 Collector Dark Current vs. Ambient Temperature

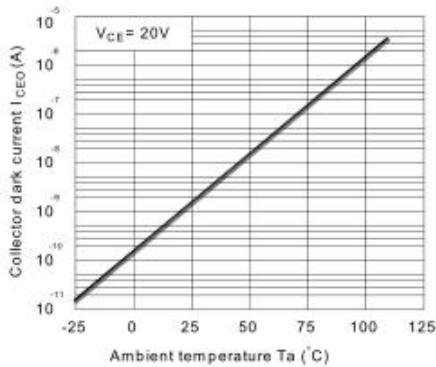

Fig.10 Response Time vs. Load Resistance

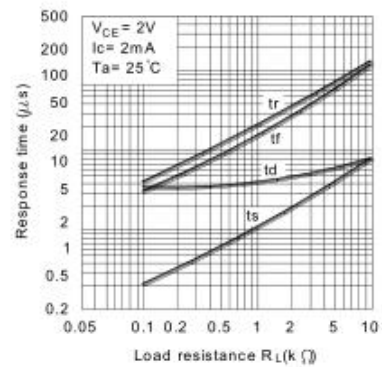
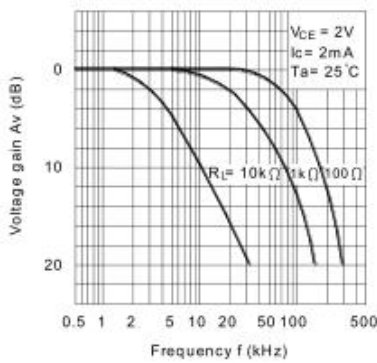
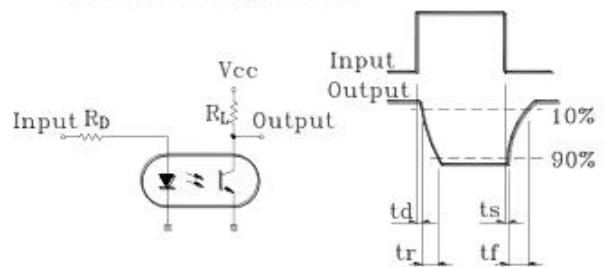

Fig.11 Frequency Response



Test Circuit for Response Time



Test Circuit for Frequency Response

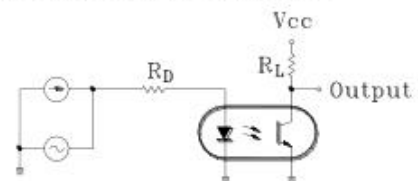

X-ON Electronics

Largest Supplier of Electrical and Electronic Components

Click to view similar products for [High Speed Optocouplers](#) category:

Click to view products by [Orient](#) manufacturer:

Other Similar products are found below :

[6N136F](#) [HCPL-2201-300](#) [JAN4N24](#) [610737H](#) [HCPL2630M](#) [HCPL2630SM](#) [PS9817A-1-F3-AX](#) [PS9821-2-F3-AX](#) [TLP2766A\(E](#)
[TLP2766A\(LF4,E](#) [ACPL-K43T-500E](#) [PS9121-F3-AX](#) [PS9123-F3-AX](#) [TLP5774H\(TP4,E](#) [TLP5771H\(TP,E](#) [TLP2304\(E\(O](#) [054279X](#)
[HCPL2631SD](#) [HCPL-2730-500E](#) [TLP109\(E\(T](#) [TLP116A\(E\(T](#) [TLP118\(TPL,E\)](#) [TLP2309\(E\(T](#) [TLP2366\(TPL,E](#) [TLP521-2XGB](#) [TLP621-](#)
[2XGB](#) [JANTXV4N24U](#) [8102802PC](#) [5962-8767902XA](#) [5962-8876801XA](#) [5962-8957101PA](#) [SFH6318T](#) [6N135-300E](#) [TIL198](#)
[TLP104\(TPR,E\)](#) [TLP2309\(TPL,E\)](#) [TLP2355\(TPL,E](#) [TLP2358\(E\)](#) [TLP521-4GR](#) [TLP521-4XGB](#) [TLP621XSM](#) [5962-8876801PA](#) [IS281-4GB](#)
[IS2805-4](#) [IS181GR](#) [ICPL2630](#) [ICPL2601](#) [ICPL2530](#) [5962-8876801PC](#) [TLP2301](#)