



ORIENT

Photocoupler

Product Data Sheet

Name: ORPC-814

Customer: _____

Date: _____

1.Features

- (1) AC input response.
- (2) Current transfer ratio (CTR : MIN. 20% at IF = ±1mA, VCE = 5V)
- (3) Wide Operating temperature range -55~110°C
- (4) High input-output isolation voltage (Viso = 5,000Vrms)
- (5) Response time (tr : TYP. 4us at VCE = 2V, IC = 2mA, RL = 100)
- (6) High collector-emitter voltage (VCE ≧ 80V)
- (7) Safety approval
 - UL approved (No.E323844)
 - VDE approved (No.40029733)
 - CQC approved (No.CQC09001029446 CQC13001086898)
 - CE approved (No.AC/0431008)
 - State Grid approved (No.SGCM013420170152)



2. Description

- (1) The ORPC-814 series of devices each consist of two infrared emitting diodes, connected in inverse parallel, optically coupled to a phototransistor detector.
- (2) They are packaged in a 4-pin DIP package and available in side-lead spacing and SMD option.

3. Applications

- (1)AC line monitor
- (2)Programmable controllers
- (3)Telephone line interface
- (4)Unknown polarity DC sensor

4.Absolute Maximum Ratings at Ta=25°C

Parameter		Symbol	Rated Value	Unit
Input	Forward Current	IF	±50	mA
	Peak forward current (100µs pulse, 100Hz frequency)	IFP	1	A
	Reverse Voltage	VR	6	V
	Consume Power	P	70	mW
Output	Collector and emitter Voltage	VCEO	80	V
	Emitter and collector Voltage	VECO	6	
	Collector Current	IC	50	mA
	Consume Power	PC	150	mW
Total Power Dissipation		Ptot	200	mW
*1 Isolation Voltage		Viso	5,000	Vrms
Operating Temperature		Topr	-50 to + 110	°C
Storage Temperature		Tstg	-55 to + 125	
*2 Soldering Temperature		Tsol	260	

1. AC For 1 Minute, R.H. = 40 ~ 60%

Isolation voltage shall be measured using the following method.

- (1) Short between anode and cathode on the primary side and between collector and emitter on the secondary side.
- (2) The isolation voltage tester with zero-cross circuit shall be used.
- (3) The waveform of applied voltage shall be a sine wave.

2. For 10 Seconds

5. Electro-Optical Characteristics (Ta=25°C unless specified otherwise)

Parameter		Symbol	Condition	Min	Typ.*	Max	Unit
Input	Forward Current	V_F	$I_F = \pm 20\text{mA}$	---	1.2	1.4	V
	Collector capacitance	C_t	$V=0, f=1\text{KHz}$	---	30	250	pF
Output	Collector to emitter Current	I_{CEO}	$V_{CE}=20\text{V}, I_F=0\text{mA}$	---	---	100	nA
	Collector and Emitter attenuation Voltage	BV_{CEO}	$I_C=0.1\text{mA}, I_F=0\text{mA}$	80	---	---	V
	Emitter and Collector attenuation Voltage	BV_{ECO}	$I_E=10\mu\text{A}, I_F=0\text{mA}$	6	---	---	V
Transforming Characteristics	*1 Current conversion ratio	CTR		20	---	300	%
	Collector Current	I_C	$I_F = \pm 1\text{mA}, V_{CE}=5\text{V}$	0.2	---	3	mA
	Collector and Emitter Saturation Voltage	$V_{CE(sat)}$	$I_F = \pm 20\text{mA}, I_C = 1\text{mA}$	---	0.1	0.2	V
	Insulation Impedance	R_{iso}	DC500V 40~60%R.H.	---	1×10^{12}	---	Ω
	Floating Capacitance	C_f	$V=0, f=1\text{MHz}$	---	0.6	1.0	pF
	Cut-off Frequency	f_c	$V_{CE}=5\text{V}, I_C=2\text{mA}, R_L=100\Omega, -3\text{dB}$	---	80	---	kHz
	Rise Time	t_r	$V_{CE}=2\text{V}, I_C=2\text{mA}$	---	4	18	μs
	Descend Time	t_f	$R_L=100\Omega$	---	3	18	μs

*1 Current Conversion Ratio = $I_C / I_F \times 100\%$

6. Rank Table of Current Transfer Ratio

	CTR Rank	Min	Max	Condition
ORPC-814	A	50	150	$I_F = \pm 1mA$
	B	100	300	$V_{CE} = 5V$
	A or B or No mark	20	300	$T_a = 25^\circ C$

7. Naming Rule

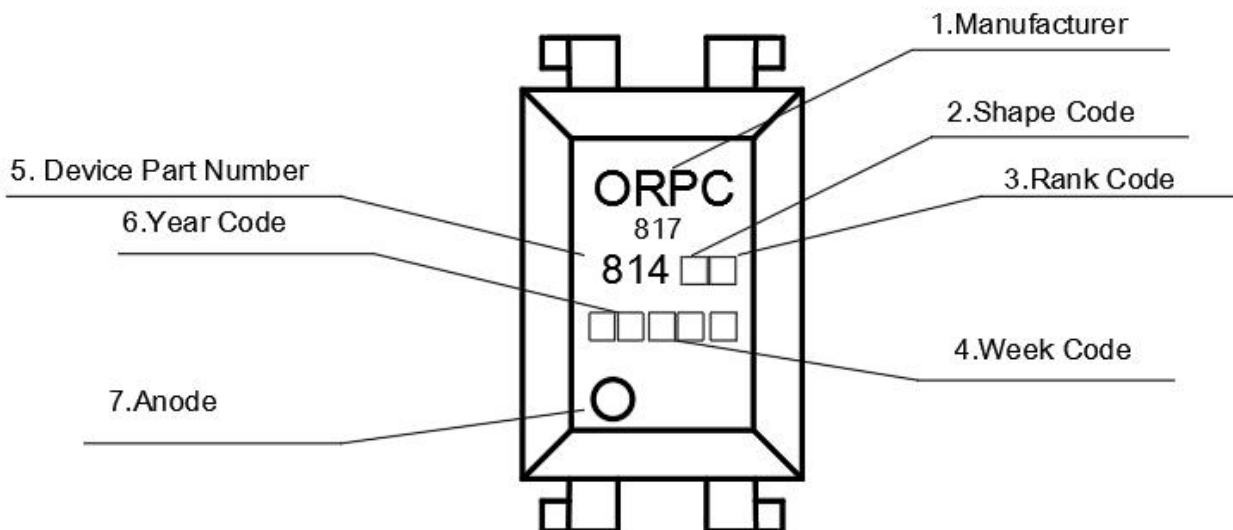

(1)ORPC denotes Shenzhen Orient Tech Ltd . Co ., Ltd.

(2) □ denotes Shape Code.

(3) □□ denotes Rank code.

(4) □□□ denotes Week code.

(5) □□□ denotes Device Part Number.

(6) □ denotes Year Code

(7) Anode.

(8) Unit:mm

8. Package Dimension (Unit: mm)

1.ORPC-814

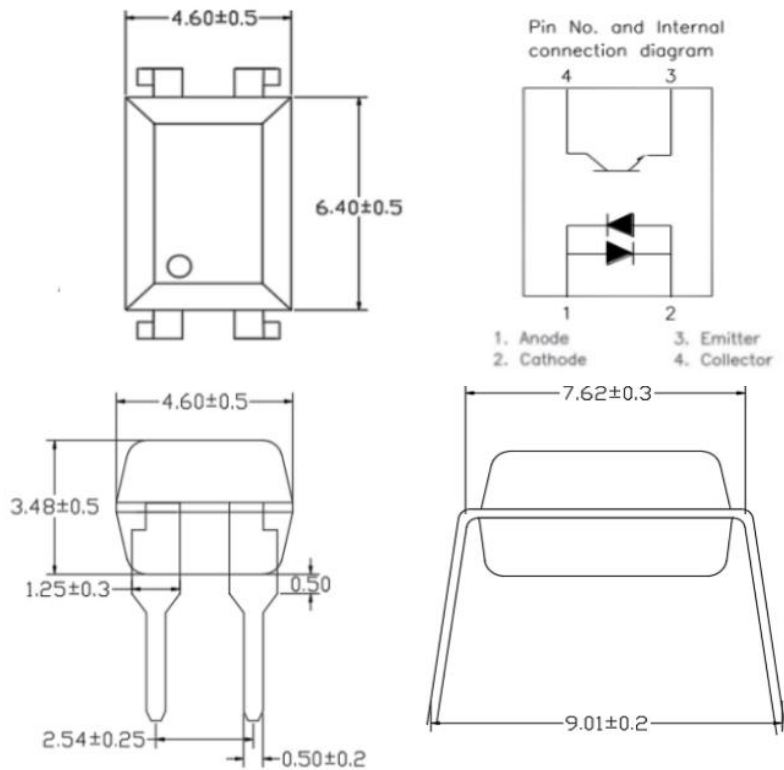

2.ORPC-814M

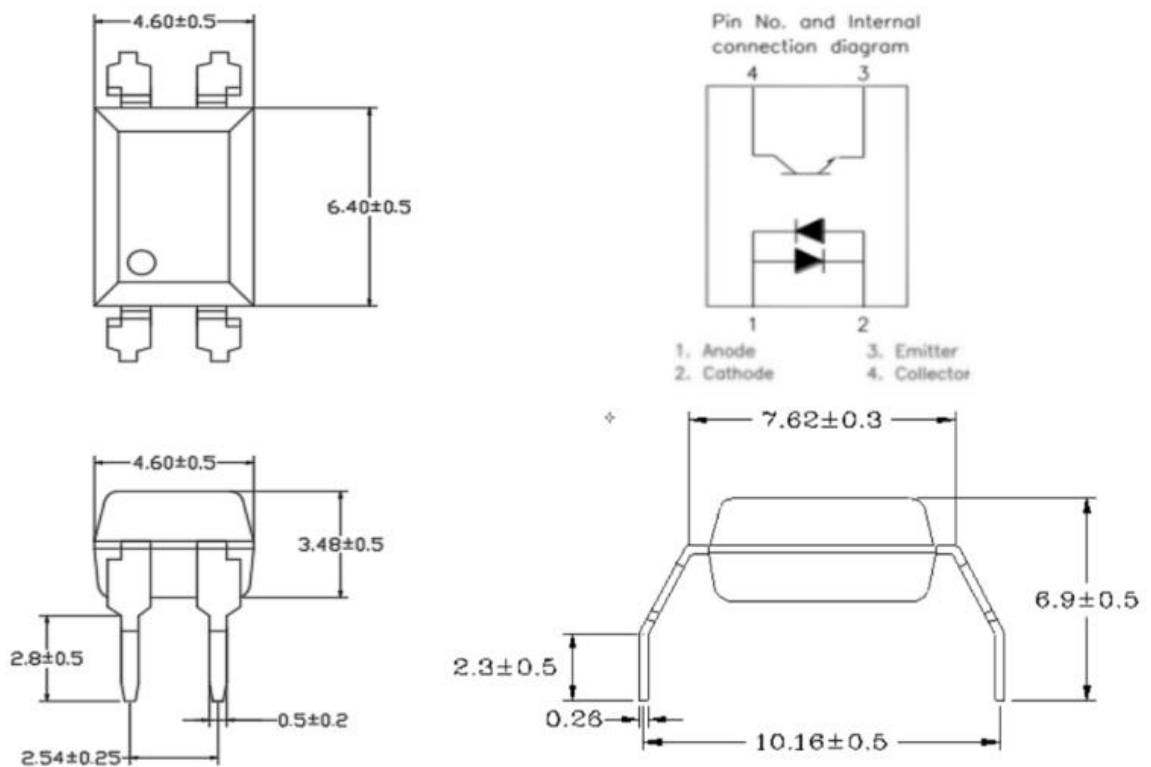

3.ORPC-814S

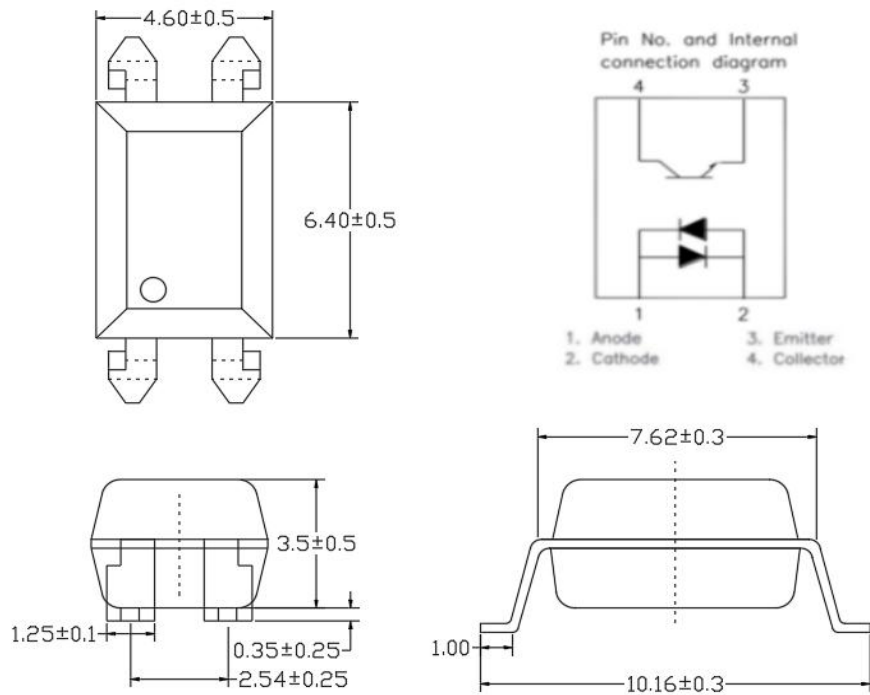

9.Taping Dimensions

(1) ORPC-814S-TA

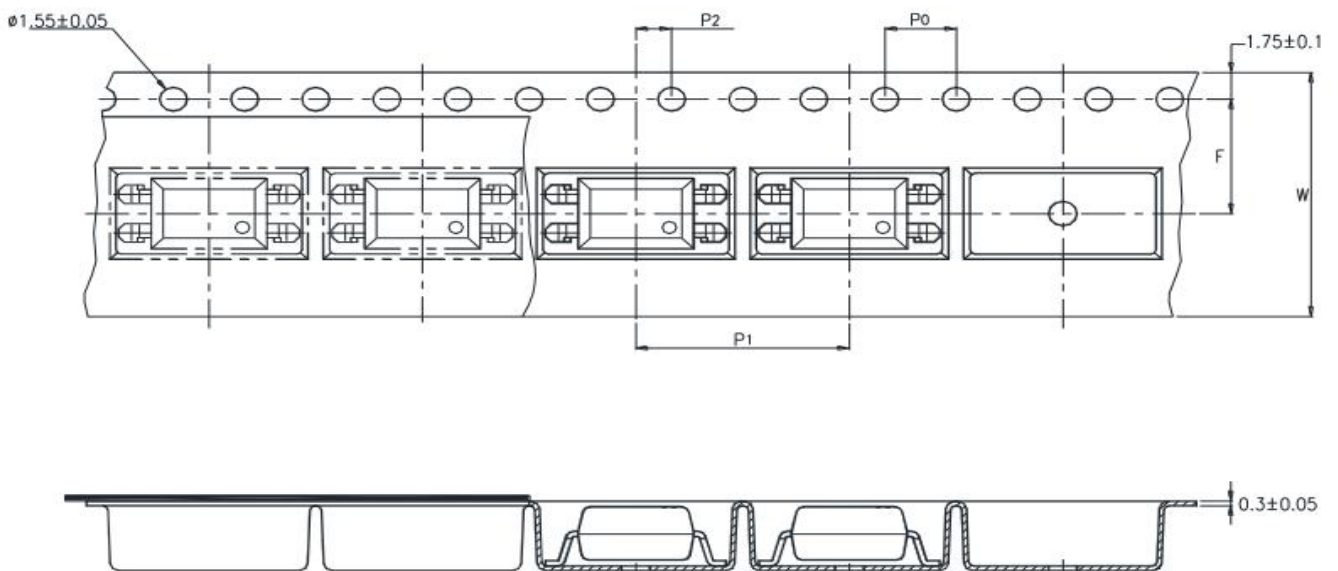

(2) ORPC-814S-TA1

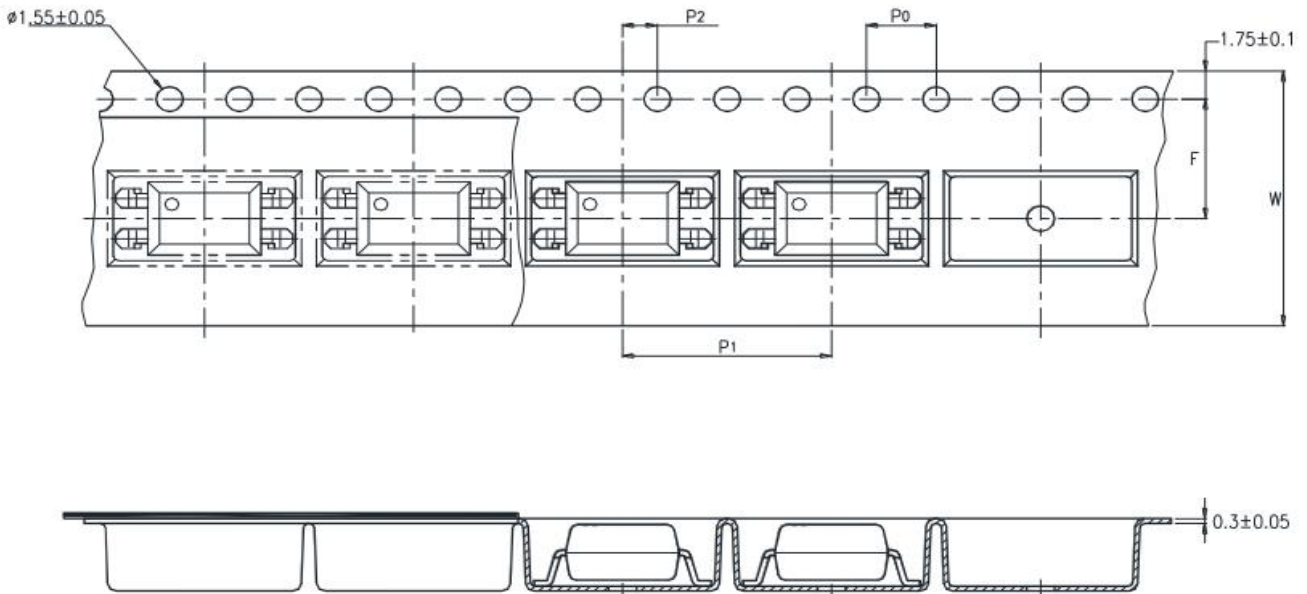

Description	Symbol	Dimension in mm (inch)
Tape wide	W	16±0.3 (.63)
Pitch of sprocket holes	P_0	4±0.1 (.15)
Distance of compartment	F	7.5±0.1 (.295)
	P_2	2±0.1 (.0079)
Distance of compartment to compartment	P_1	12±0.1 (.472)

Package Type	TA/TA1
Quantities(pcs)	1000

(3) ORPC-814S-TP

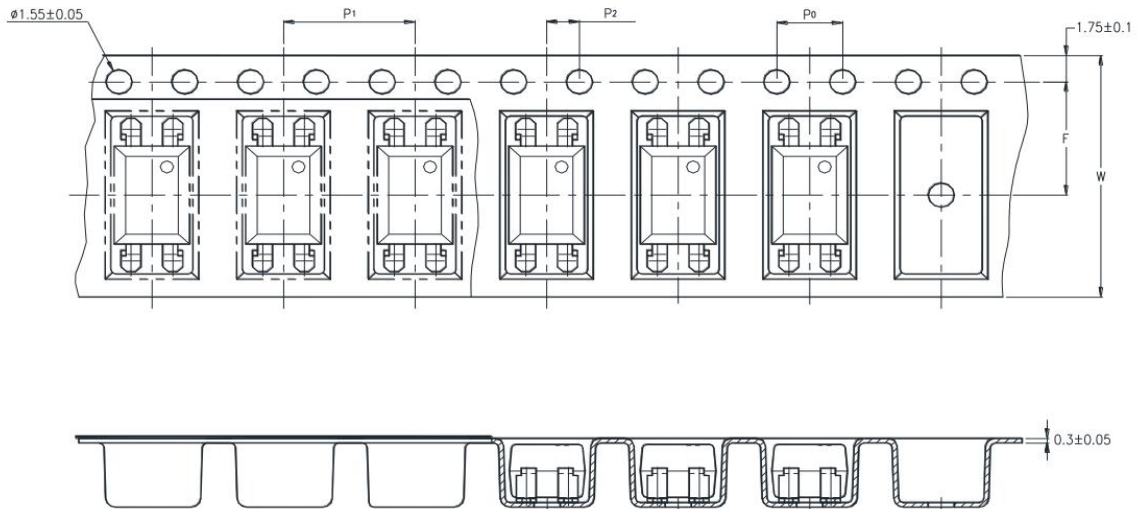

Description	Symbol	Dimension in mm (inch)
Tape wide	W	16 ± 0.3 (.63)
Pitch of sprocket holes	P_0	4 ± 0.1 (.15)
Distance of compartment	F	7.5 ± 0.1 (.295)
	P_2	2 ± 0.1 (.0079)
Distance of compartment to compartment	P_1	8 ± 0.1 (.472)

Package Type	TP
Quantities(pcs)	2000

10.Recommended Foot Print Patterns (Mount Pad) (Unit: mm)



11. Temperature Profile Of Soldering

(1).IR Reflow soldering (JEDEC-STD-020C compliant)

One time soldering reflow is recommended within the condition of temperature and time profile shown below. Do not solder more than three times.

Profile item	Conditions
Preheat	
- Temperature Min (T _{Smin})	150°C
- Temperature Max (T _{Smax})	200°C
- Time (min to max) (ts)	90±30 sec
Soldering zone	
- Temperature (TL)	217°C
- Time (t _L)	60 sec
Peak Temperature(T _P)	260°C
Ramp-up rate	3°C / sec max.
Ramp-down rate	3~6°C / sec

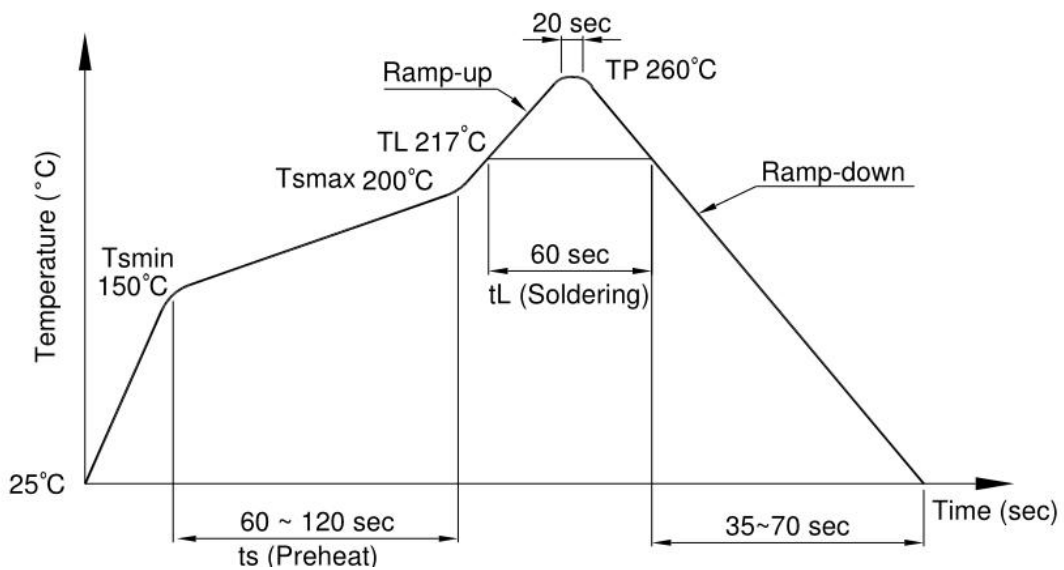

(2).Wave soldering (JEDEC22A111 compliant)

One time soldering is recommended within the condition of temperature.

Temperature	260+0/-5°C
Time	10 sec
Preheat temperature	25 to 140°C
Preheat time	30 to 80 sec

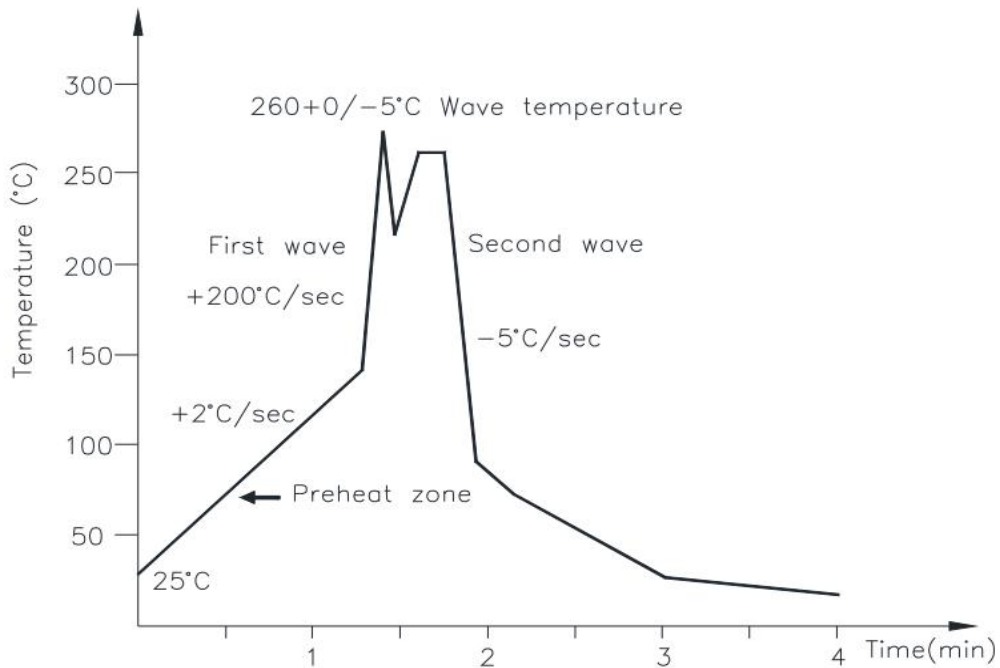

(3).Hand soldering by soldering iron

Allow single lead soldering in every single process. One time soldering is recommended.

Temperature	380+0/-5°C
Time	3 sec max

12.Characteristics Curves

Fig.1 Forward Current vs. Ambient Temperature

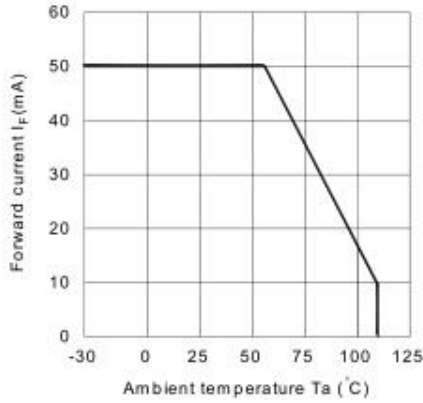

Fig.2 Collector Power Dissipation vs. Ambient Temperature

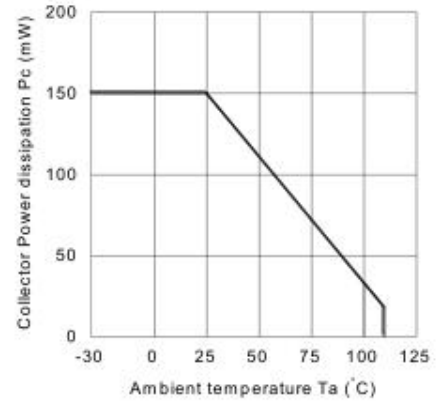

Fig.3 Collector-emitter Saturation Voltage vs. Forward Current

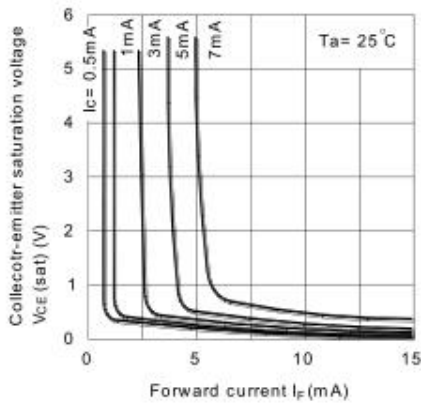

Fig.4 Forward Current vs. Forward Voltage

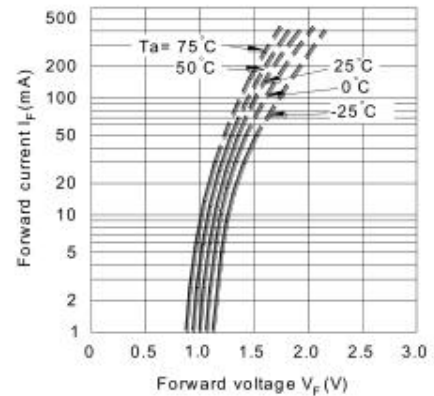

Fig.5 Current Transfer Ratio vs. Forward Current

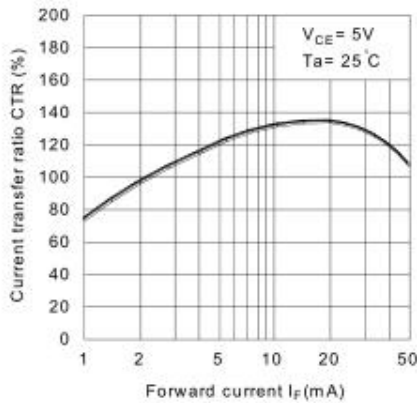

Fig.6 Collector Current vs. Collector-emitter Voltage

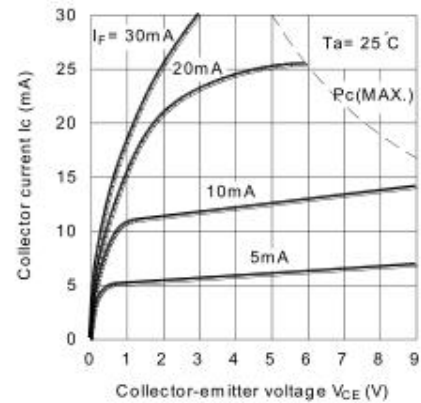

Fig.7 Relative Current Transfer Ratio vs. Ambient Temperature

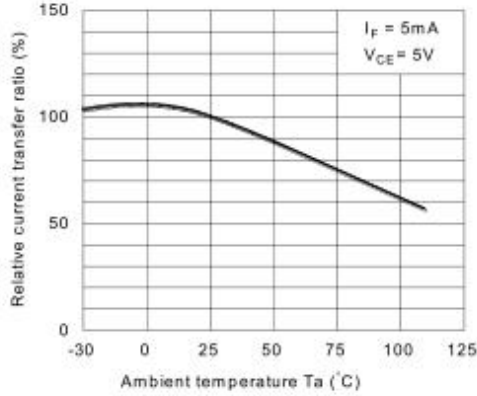

Fig.8 Collector-emitter Saturation Voltage vs. Ambient Temperature

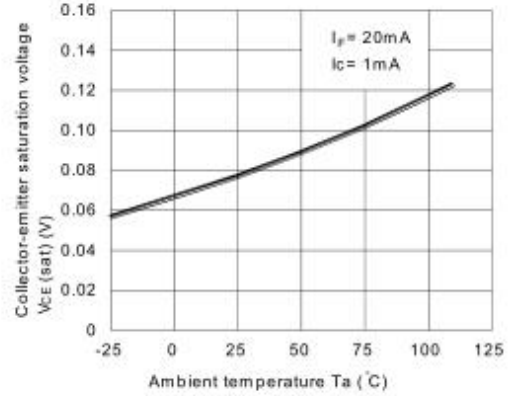

Fig.9 Collector Dark Current vs. Ambient Temperature

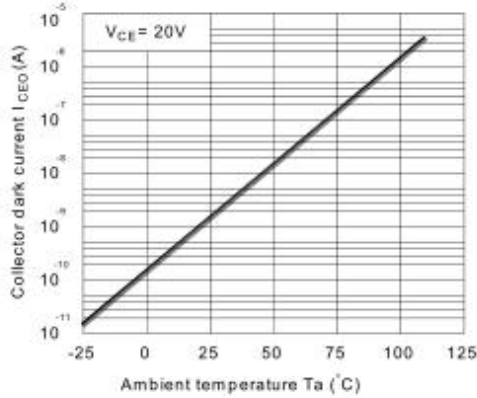

Fig.10 Response Time vs. Load Resistance

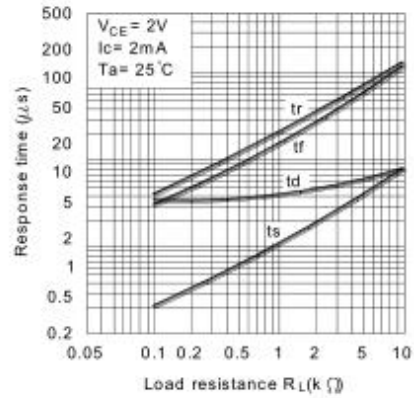
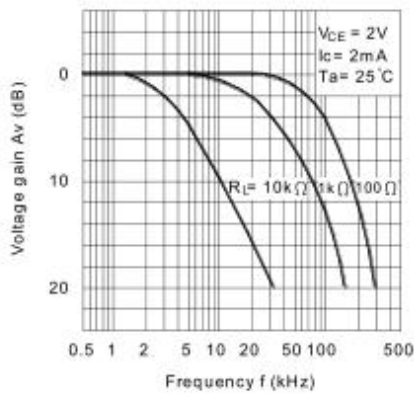
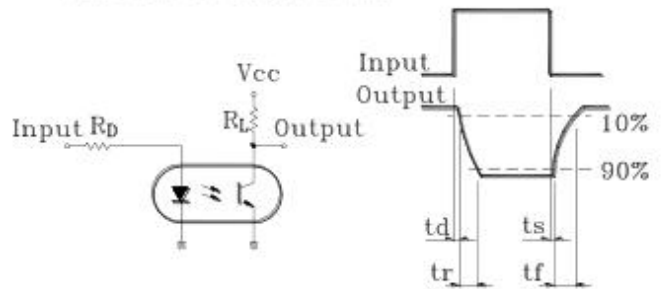

Fig.11 Frequency Response



Test Circuit for Response Time



Test Circuit for Frequency Response

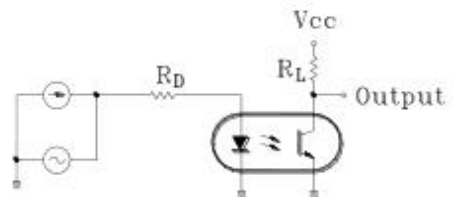

X-ON Electronics

Largest Supplier of Electrical and Electronic Components

Click to view similar products for [Photodiode Output Optocouplers](#) category:

Click to view products by [Orient](#) manufacturer:

Other Similar products are found below :

[TLP590B\(C,F\)](#) [TLP7820\(A-LF4.E\(O](#) [LTV-244-GB-G](#) [LTV2301GB-V-G](#) [EL816S1\(C\)\(TU\)](#) [EL817S1\(C\)\(TU\)-VG](#) [GX357NC](#) [PC817B](#)
[PC817C](#) [LTV-341W-TA1-H](#) [LTV-176G](#) [LTV-1003-TP1-G](#) [LTV-247-G-RT](#) [PC817B-MS](#) [FOC-817C-F](#) [CYPS2501-1\(K\)](#)
[CYTLP2362\(TPD2\)](#) [OR-3H7C-TP-G-\(GK\)](#) [ORPC-817MC-F](#) [ORPC-817D-C](#) [ORPC-817SB-TP-F](#) [PS2801C-4-F3-A/M](#) [PC817B](#)
[TLP183\(YH-TPL,E\(T](#) [TLP183\(GRH-TPL,E\(T](#) [TLP183\(TPL,E\(T](#) [TLP291\(BL-TP,SE\(T](#) [TLP184\(V4GBTL,SE\(T](#) [TLP785\(BLL-TP6,F\(C](#)
[TLP293\(GRH-TPL,E\(T](#) [TLP383\(D4GL-TR,E](#) [TLP185\(BLL-TL,SE\(T](#) [TLP2309\(TPL,E\(O](#) [TLP785\(BL-TP6,F\(C](#) [TLP185\(GRL-TL,SE\(T](#)
[TLP785\(GR-TP6,F\(C](#) [TLP183\(BL-TPL,E\(T](#) [TLP2398\(TPL,E\(T](#) [TLP127GB-S](#) [LTV-354T-A\(UMW\)](#) [6N136S\(UMW\)](#) [PC817B-S](#) [FOC-817C](#)
[EL1018](#) [IS121A](#) [IS2701-1A](#) [IS3H7A](#) [IS121D](#) [IS2701-1C](#) [IS121GB](#)