



Specification

PRODUCT NAME: Photocoupler
PART NO.: ORPC-817

●Feature:

1. Current conversion ratio (Min 50% Working condition $I_F=5\text{mA}$, $V_{CE}=5\text{V}$)
2. Insulation Voltage= $5,000\text{V}_{\text{rms}}$
3. Response Time (t_r : TYP. $4\mu\text{s}$, Operating condition: $V_{CE}=2\text{V}$, $I_C=2\text{mA}$, $R_L=100\ \Omega$)

●Instruction

1. ORPC-817S photocoupler consist of one piece of GaAs emitter and one piece of NPN transistor
2. Bin width of ORPC-817 is 2.54mm

●Application Range

1. Computer
2. Instrument application, measurement machine
3. Imbursement equipments, duplicating machine, automat.
4. Family-use electric equipments, such as fans
5. Signal transforming systems

●Max Absolute rated Value(Normal Temperature=25°C

Parameter		Symbol	Rated Value	Unit
Input	Forward Current	I_F	50	mA
	Reverse Voltage	V_R	6	V
	Consume Power	P	70	mW
Output	Collector and emitter Voltage	V_{CEO}	35	V
	Emitter and Collector Voltage	V_{ECO}	6	
	Collector Current	I_C	50	mA
	Consume Power	P_C	150	mW
Total Consume Power		P_{tot}	200	mW
Insulation Voltage		V_{iso}	5,000	V_{rms}
Max Insulation Voltage		V_{IOTM}	6,000	V
Rated Impulse Insulation Voltage		V_{IORM}	630	V
Working Temperature		T_{opr}	-30 to + 100	°C
Deposit Temperature		T_{stg}	-55 to + 125	
Soldering Temperature		T_{sol}	260	

*1. AC Test, 1 minute, humidity=40~60 %

Insulation test method as below:

- (1) Short circuit both terminals of photocoupler
- (2) No Current when testing insulation voltage



(3) Adding sine wave voltage when testing
 *2. soldering time is 10 seconds

●Opto-electronic Characteristics

Parameter		Symbol	Condition	Min.	Midium	Max	Unit
Input	Forward Current	VF	IF=20mA	---	1.2	1.4	V
	Reverse Voltage	IR	VR=4V	---	---	10	μA
	Collector capacitance	Ct	V=0, f=1KHz	---	30	250	pF
Output	Collector to emitter Current	ICEO	VCE=20V, IF=0	---	---	100	nA
	Collector and Emitter attenuation Voltage	BVCEO	IC=0.1mA IF=0	35	---	---	V
	Emitter and Collector attenuation Voltage	BVECO	IE=10μA IF=0	6	---	---	V
Transforming Characteristics	Collector Current	Ic	IF=5mA	2.5	---	30	mA
	Current conversion ratio	CTR	VCE=5V	50	---	600	%
	Collector and Emitter Saturation Voltage	VCE(sat)	IF=20mA IC= 1mA	---	0.1	0.2	V
	Insulation Impedance	Riso	DC500V 40~60%R.H.	5×10 ¹⁰	1×10 ¹¹	---	Ω
	capacitance	Cf	V=0, f=1MHz	---	0.6	1	pF
	Transforming Frequency	fc	VCE=5V, IC=2mA RL=100Ω, -3dB	---	80	---	kHz
	Rise Time	tr	VCE=2V, IC=2mA	---	4	18	μs
	Descend Time	tf	RL=100Ω	---	3	18	μs

*1 Current Conversion= IC / IF × 100%

●Grades of Current conversion ratio



Grade Sign	Min (%)	Max (%)
L	50	100
A	80	160
B	130	260
C	200	400
D	300	600
L or A or B or C or D	50	600

Note: Working condition: IF=5mA, VCE=5V, Ta=25°C.

●Outer Dimension

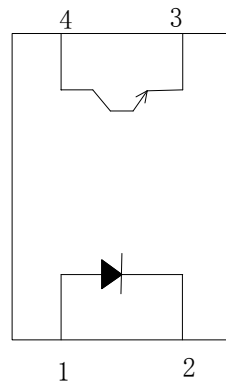
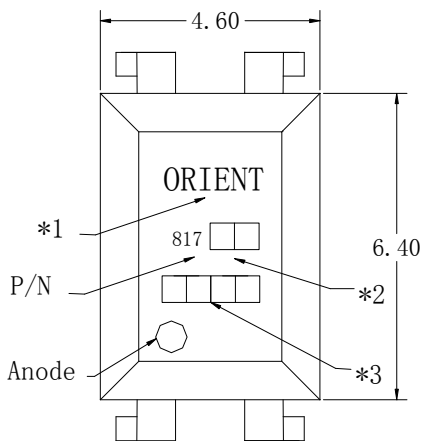

pin No. and Internal connection diagram

- 1 Anode
- 2 Cathode
- 3 Emitter
- 4 Collector

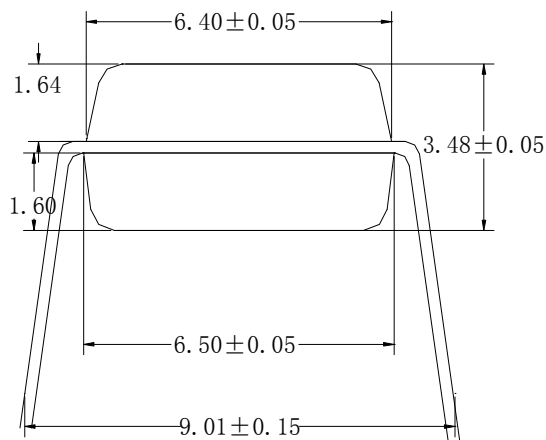
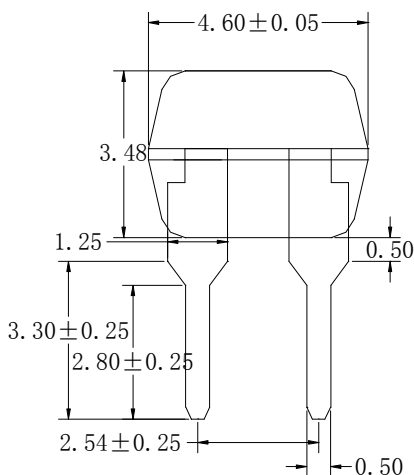

- Note:**
- *1. Company name
 - *2. Bin
 - *3. Production period

●Characteristics Curve

Fig.1 Forward Current vs. Ambient Temperature

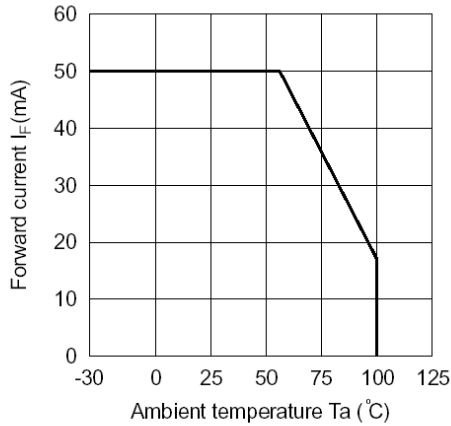

Fig.2 Collector Power Dissipation vs. Ambient Temperature

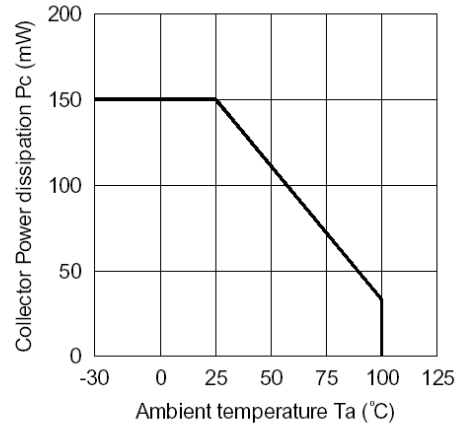

Fig.3 Collector-emitter Saturation Voltage vs. Forward Current

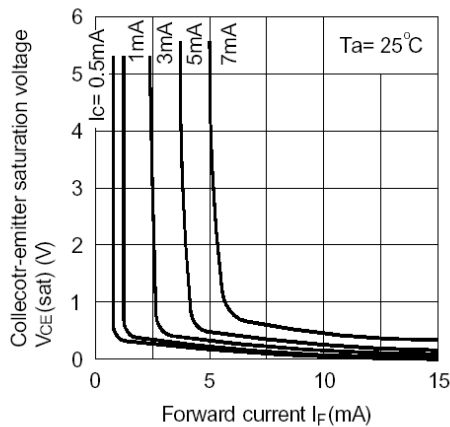

Fig.4 Forward Current vs. Forward Voltage

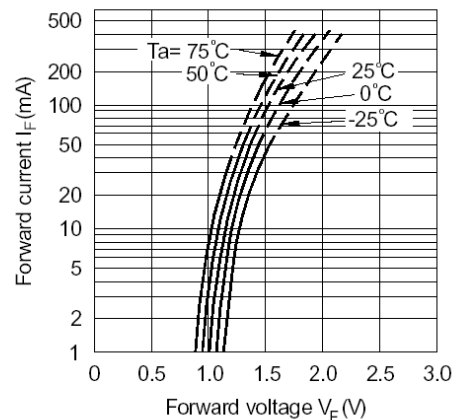

Fig.5 Current Transfer Ratio vs. Forward Current

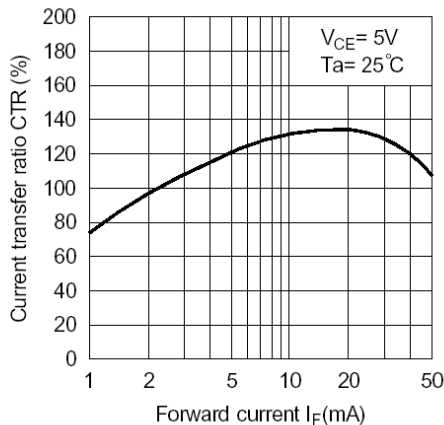
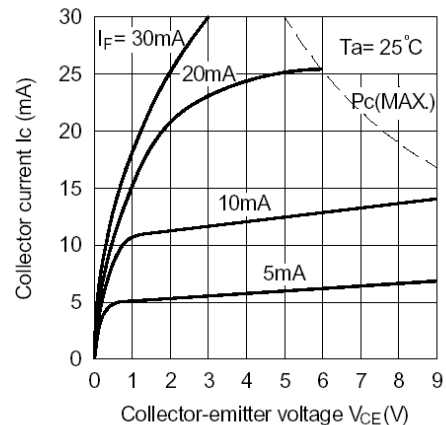

Fig.6 Collector Current vs. Collector-emitter Voltage



●Characteristics Curve

Fig.7 Relative Current Transfer Ratio vs. Ambient Temperature

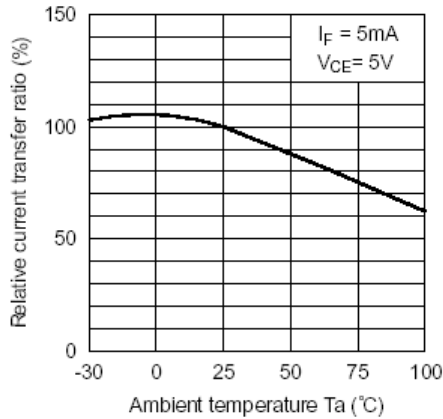

Fig.8 Collector-emitter Saturation Voltage vs. Ambient Temperature

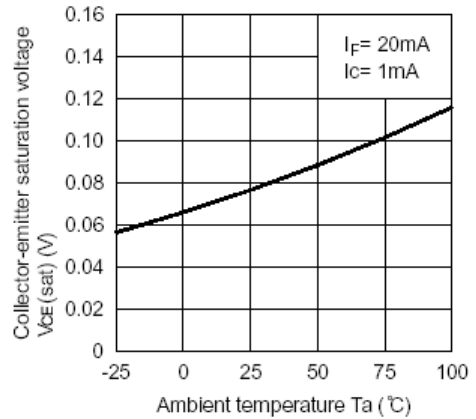

Fig.9 Collector Dark Current vs. Ambient Temperature

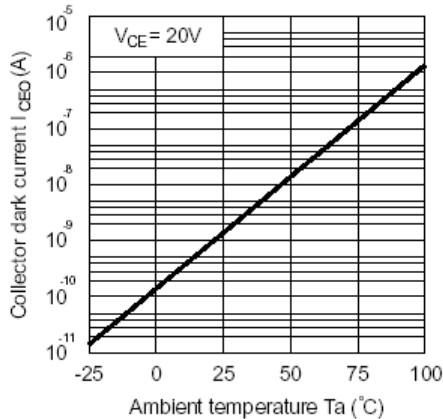

Fig.10 Response Time vs. Load Resistance

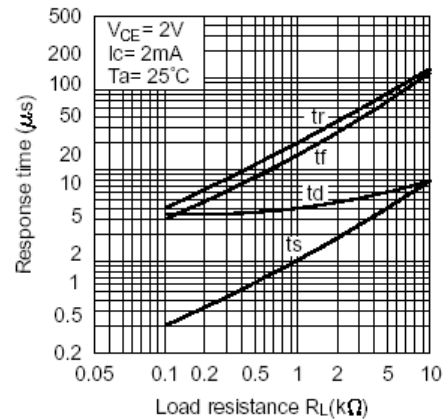
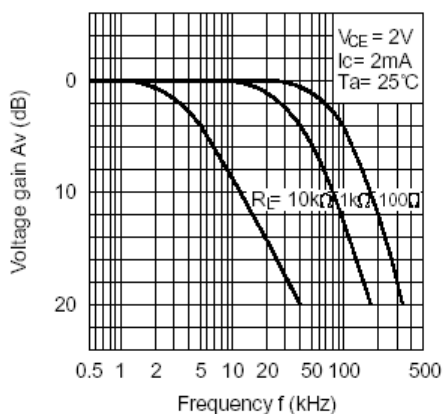
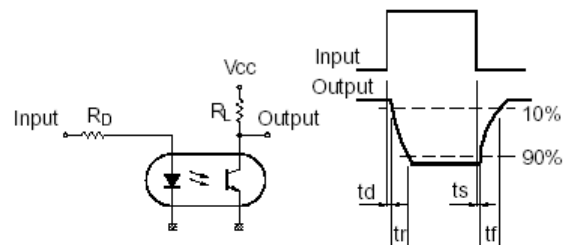

Fig.11 Frequency Response



Test Circuit for Response Time



Test Circuit for Frequency Response

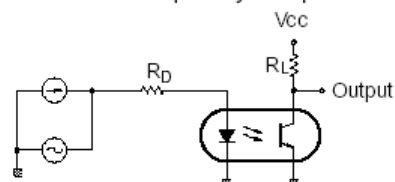

X-ON Electronics

Largest Supplier of Electrical and Electronic Components

Click to view similar products for [High Speed Optocouplers](#) category:

Click to view products by [Orient](#) manufacturer:

Other Similar products are found below :

[6N136F](#) [HCPL-2201-300](#) [JAN4N24](#) [610737H](#) [HCPL2630M](#) [HCPL2630SM](#) [PS9817A-1-F3-AX](#) [PS9821-2-F3-AX](#) [TLP2766A\(E](#)
[TLP2766A\(LF4,E](#) [PS9121-F3-AX](#) [TLP5774H\(TP4,E](#) [TLP5771H\(TP,E](#) [TLP2304\(E\(O](#) [054279X](#) [HCPL2631SD](#) [HCPL-2730-500E](#)
[TLP118\(TPL,E\)](#) [TLP2309\(E\(T](#) [TLP2366\(TPL,E](#) [TLP2368\(TPL,E\(T](#) [TLP521-2XGB](#) [TLP621-2XGB](#) [JANTXV4N24U](#) [8102802PC](#) [5962-](#)
[8767902XA](#) [5962-8876801XA](#) [5962-8957101PA](#) [SFH6318T](#) [6N135-300E](#) [TIL198](#) [TLP104\(TPR,E\)](#) [TLP2309\(TPL,E\)](#) [TLP2355\(TPL,E](#)
[TLP2358\(E\)](#) [TLP521-4GR](#) [TLP521-4XGB](#) [TLP621XSM](#) [5962-8876801PA](#) [IS281-4GB](#) [IS2805-4](#) [IS181GR](#) [ICPL2630](#) [ICPL2531](#)
[ICPL2601](#) [ICPL2530](#) [5962-8876801PC](#) [TLP2301](#) [TLP2301\(E\(T](#) [TLP2362\(TPR,E](#)