



ORIENT

Photo coupler

Product Data Sheet

Part Number: ORPC-817

Customer: _____

Date: _____

SHENZHEN ORIENT COMPONENTS CO ., LTD

Block A3rd Floor No.4 Building, Tian'an Cyber Park, Huangge Rd, LongGang Dist, Shenzhen, GD

TEL: 0755-29681817

FAX: 0755-29681200

www.orient-opto.com

1. Features

- (1) Current transfer ratio (CTR : MIN. 50% at $I_F = 5\text{mA}$, $V_{CE} = 5\text{V}$)
- (2) High input-output isolation voltage ($V_{iso} = 5,000\text{Vrms}$)
- (3) Response time (t_r : TYP. $4\mu\text{s}$ at $V_{CE} = 2\text{V}$, $I_C = 2\text{mA}$, $R_L = 100\Omega$)
- (4) MSL Class I
- (5) Safety approval
 - UL approved (No.E323844) VDE approved(No.40029733)
 - CQC approved (No.CQC09001029446 CQC13001086898)
 - CE approved (No.AC/0431008)
 - State Grid approved (No.SGCM013420170152)



2. Description

- (1) ORPC-817 photo coupler consist of one piece of GaAs emitter and one piece of NPN transistor.
- (2) They are packaged in a 4-pin DIP package and available in wide-lead spacing and SMD option.

3. Applications

- (1) Switching power supply
- (2) Ammeter
- (3) Computer
- (4) Instrumental application, measurement machine
- (5) Imbursement equipments, duplicating machine, automat
- (6) Family-use electric equipments, such as fans
- (7) Signal transforming systems

4. Absolute Maximum Ratings at $T_a=25^\circ\text{C}$

Parameter		Symbol	Rated Value	Unit
Input	Forward Current	I_F	60	mA
	Peak forward current (100 μs pulse, 100Hz frequency)	I_{FP}	1	A
	Reverse Voltage	V_R	6	V
	Consume Power	P	70	mW
Output	Collector and emitter Voltage	V_{CEO}	80	V
	Emitter and collector Voltage	V_{ECO}	7	
	Collector Current	I_C	50	mA
	Consume Power	P_C	150	mW
Total Consume Power		P_{tot}	200	mW
*1 Insulation Voltage		V_{iso}	5,000	Vrms
Max Insulation Voltage (Insulating oil test)		V_{IOTM}	10,000	V
Rated Impulse Insulation Voltage		V_{IORM}	630	V
Working Temperature		T_{opr}	-55 to + 110	°C
Deposit Temperature		T_{stg}	-55 to + 125	
*2 Soldering Temperature		T_{sol}	260	

*1.AC For 1 Minute, R.H. = 40 ~ 60%

Isolation voltage shall be measured using the following method.

- (1) Short between anode and cathode on the primary side and between collector and emitter on the secondary side.
- (2) The isolation voltage tester with zero-cross circuit shall be used.
- (3) The waveform of applied voltage shall be a sine wave.

*2. Soldering time is 10 seconds

5. Electro-Optical Characteristics (Ta=25°C unless specified otherwise)

Parameter		Symbol	Condition	Min	Typ.*	Max	Unit
Input	Forward Current	V_F	$I_F=20\text{mA}$	---	1.2	1.4	V
	Reverse Current	I_R	$V_R=5\text{V}$	---	---	5	μA
	Collector capacitance	C_t	$V=0, f=1\text{KHz}$	---	30	250	pF
Output	Collector to emitter Current	I_{CEO}	$V_{CE}=20\text{V}, I_F=0\text{mA}$	---	---	100	nA
	Collector and Emitter attenuation Voltage	BV_{CEO}	$I_C=0.1\text{mA}, I_F=0\text{mA}$	80	---	---	V
	Emitter and Collector attenuation Voltage	BV_{ECO}	$I_E=0.1\text{mA}, I_F=0\text{mA}$	7	---	---	V
Transforming Characteristics	*1 Current conversion ratio	CTR		50	---	1000	%
	Collector Current	I_C	$I_F=5\text{mA}, V_{CE}=5\text{V}$	2.5	---	50	mA
	Collector and Emitter Saturation Voltage	$V_{CE(sat)}$	$I_F=20\text{mA}, I_C=1\text{mA}$	---	0.1	0.2	V
	Insulation Impedance	R_{iso}	DC500V 40~60%R.H.	5×10^{10}	1×10^{12}	---	Ω
	Floating Capacitance	C_f	$V=0, f=1\text{MHz}$	---	0.6	1.0	pF
	Cut-off Frequency	f_c	$V_{CE}=5\text{V}, I_C=2\text{mA}, R_L=100\Omega, -3\text{dB}$	---	80	---	kHz
	Rise Time	t_r	$V_{CE}=2\text{V}, I_C=2\text{mA}, R_L=100\Omega$	---	4	18	μs
	Descend Time	t_f		---	3	18	μs

*1 Current Conversion Ratio = $I_C / I_F \times 100\%$, CTR Tolerance: $\pm 3\%$.

6. Rank Table of Current Transfer Ratio

(1) ORPC-817

Grade Sign	Min (%)	Max (%)
ORPC-817L	50	100
ORPC-817A	80	160
ORPC-817B	130	260
ORPC-817C	200	400
ORPC-817D	300	600
ORPC-817H	600	1000

Note: Working condition: $I_F=5\text{mA}$, $V_{CE}=5\text{V}$, $T_a=25^\circ\text{C}$.

(2) ORPC-817M

Grade Sign	Min (%)	Max (%)
ORPC-817ML	50	100
ORPC-817MA	80	160
ORPC-817MB	130	260
ORPC-817MC	200	400
ORPC-817MD	300	600
ORPC-817MH	600	1000

Note: Working condition: $I_F=5\text{mA}$, $V_{CE}=5\text{V}$, $T_a=25^\circ\text{C}$.

(3) ORPC-817S

Grade Sign	Min (%)	Max (%)
ORPC-817SL	50	100
ORPC-817SA	80	160
ORPC-817SB	130	260
ORPC-817SC	200	400
ORPC-817SD	300	600
ORPC-817SH	600	1000

Note: Working condition: $I_F=5\text{mA}$, $V_{CE}=5\text{V}$, $T_a=25^\circ\text{C}$.



7. Order Information

Part Number

ORPC-817XT-V-W-Y-Z

Note

X = Lead form option (S, M or none)

T = CTR Rank (L, A, B, C, D, H or none)

V = Tape and reel option (TP, TP1 or none).

W = Lead frame option (F: Iron, C:copper)

Y = 'V' code for VDE safety (This options is not necessary).

Z = 'G' code for Halogen free (This options is not necessary).

* VDE Code can be selected.

* Halogen Free can be selected.

Option	Description	Packing quantity
None	Standard DIP-4	100 units per tube
M	Wide lead bend (0.4 inch spacing)	100 units per tube
S(TP)	Surface mount lead form (low profile) + TP tape & reel option	2000 units per reel
S(TP1)	Surface mount lead form (low profile) + TP1 tape & reel option	2000 units per reel

8. Naming Rule

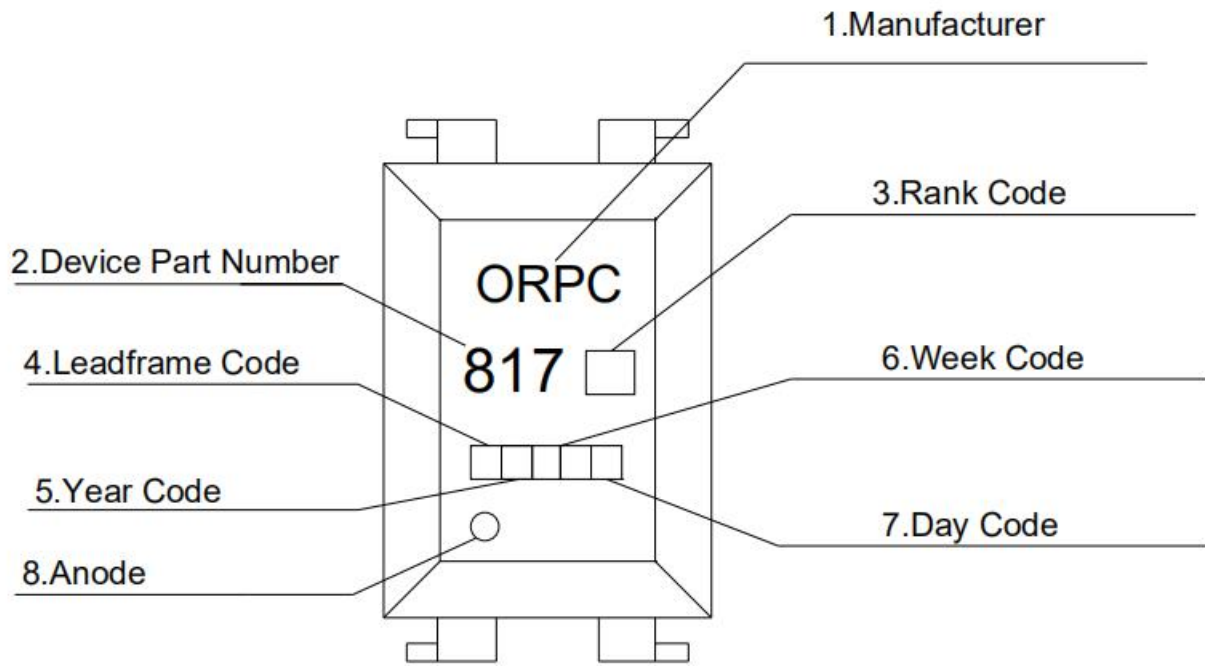

(1) ORIENT PHOTOCOUPLER.

(2) 817 denotes Device Part Number.

(3) denotes Rank Code.

(4) denotes Lead Frame Code.

(5) denotes Year Code.

(6) denotes Week Code.

(7) denotes Day Code.

(8) Anode.

* Halogen Free Mark can be selected.

* VDE Mark can be selected.

9. Package Dimension (Unit: mm)

(1) ORPC-817

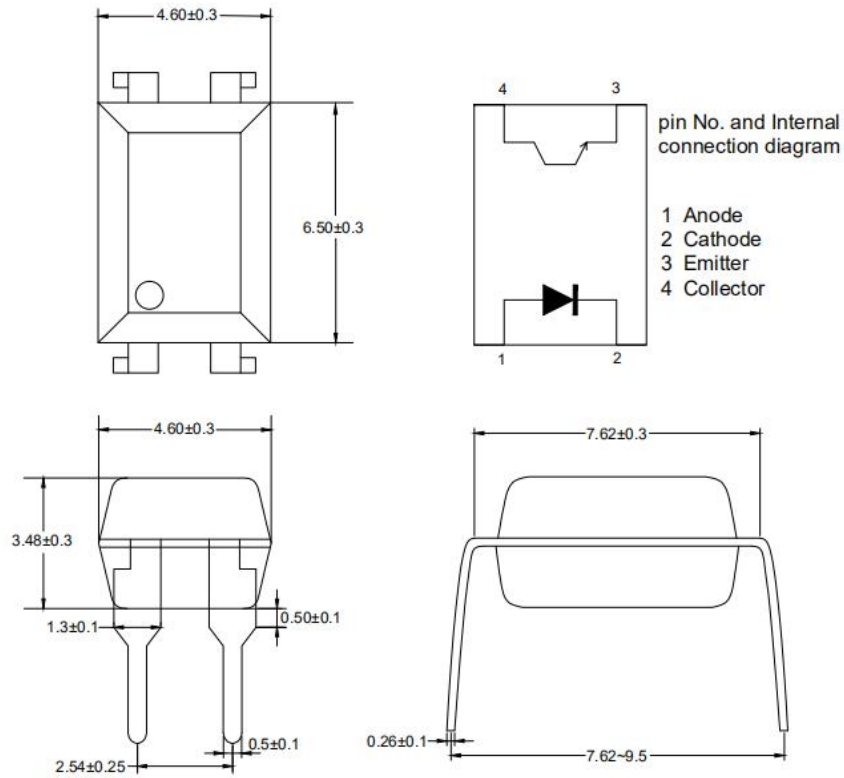

(2) ORPC-817M

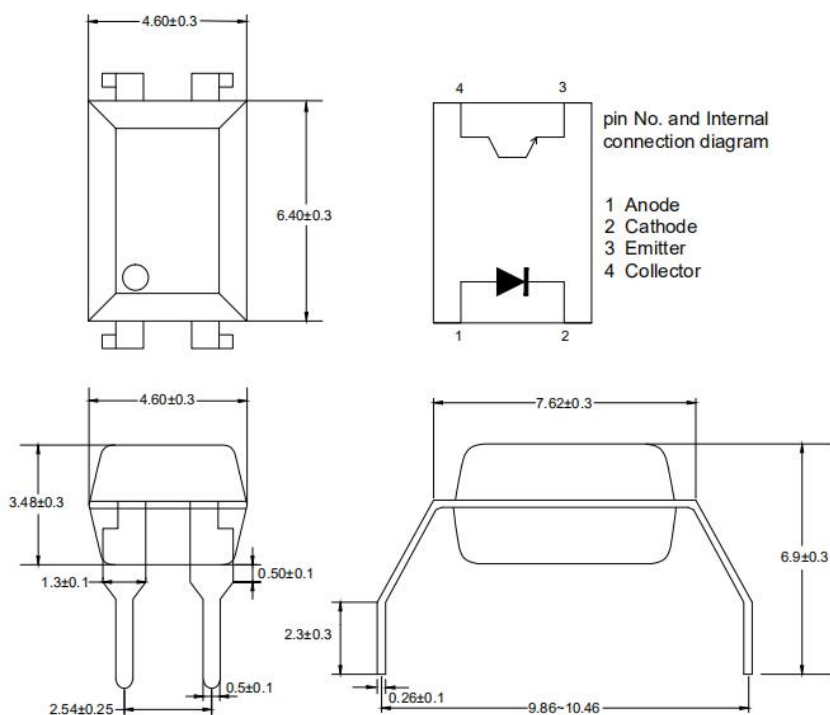

(3) ORPC-817S

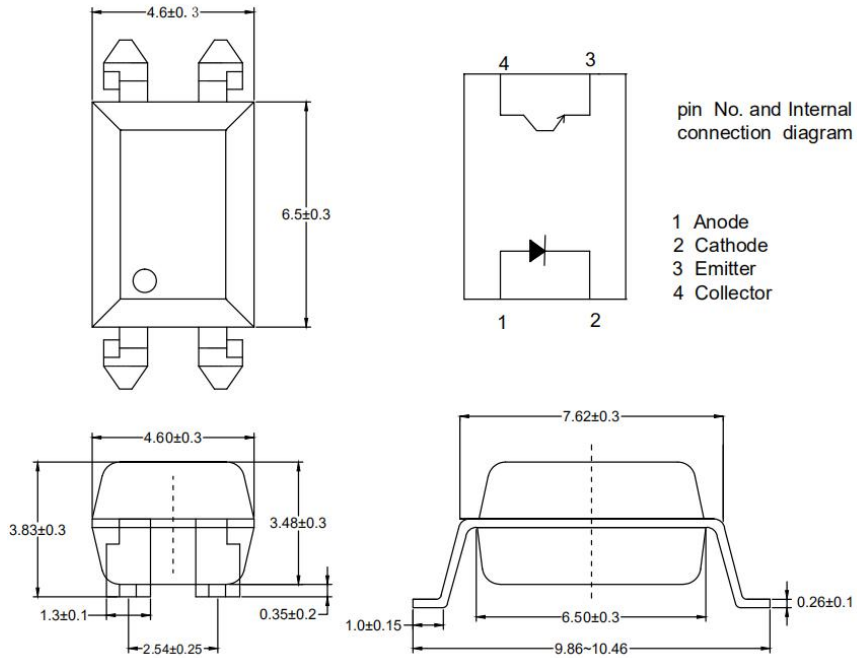

10. Taping Dimensions

(1) ORPC-817S-TP

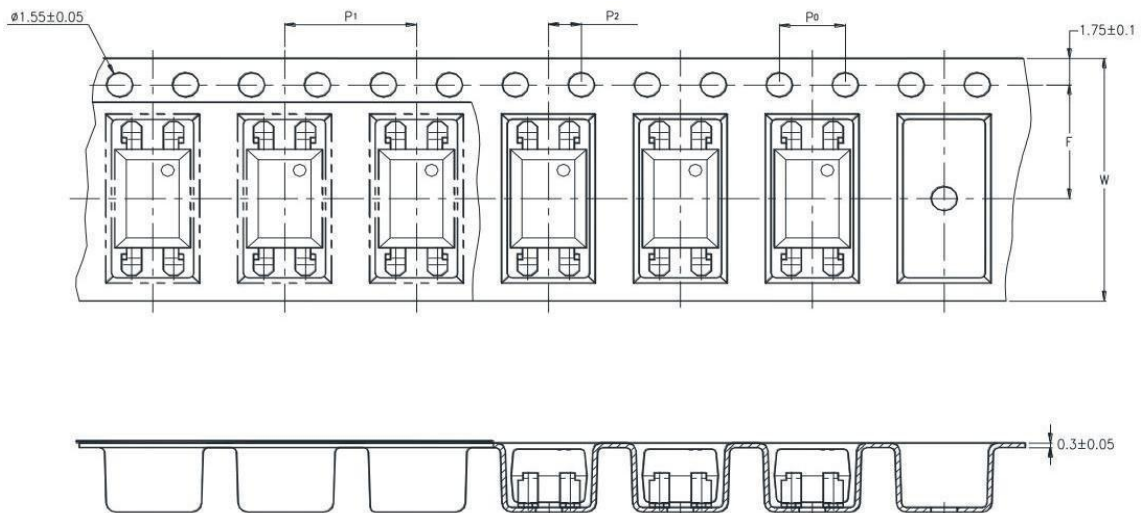

(2)ORPC-817S-TP1

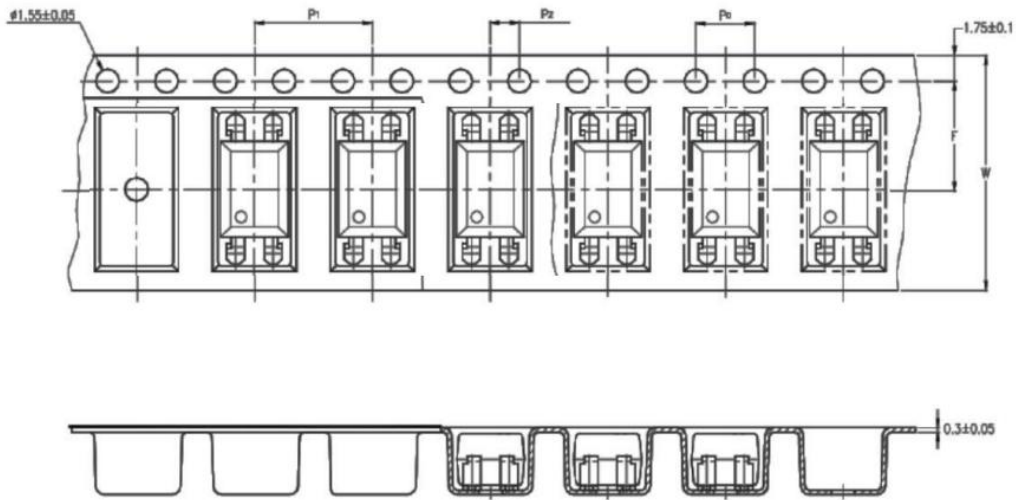

Description	Symbol	Dimension in mm (inch)
Tape wide	W	16 ± 0.3 (.63)
Pitch of sprocket holes	P_0	4 ± 0.1 (.15)
Distance of compartment	F	7.5 ± 0.1 (.295)
	P_2	2 ± 0.1 (.0079)
Distance of compartment to compartment	P_1	8 ± 0.1 (.472)

Package Type	TP/TP1
Quantities(pcs)	2000

11. Recommended Foot Print Patterns (Mount Pad) (Unit: mm)

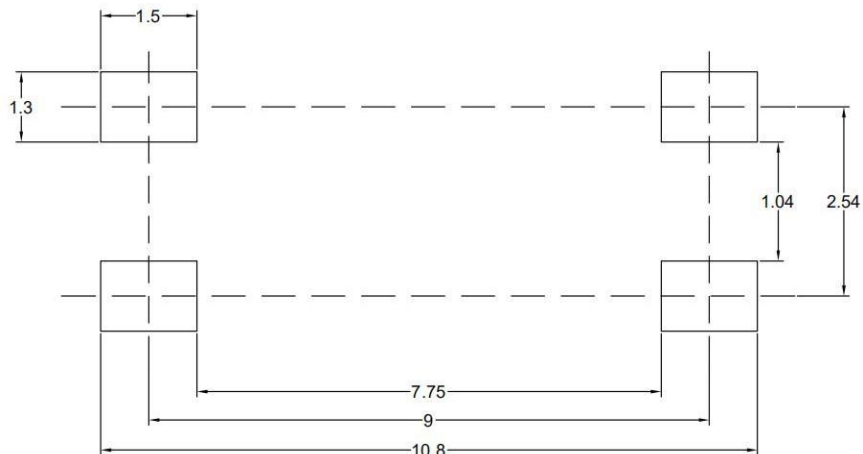

12. Package Dimension

(1) package dimension

DIP/M type

Packing Information	
Packing type	Tube(Plug)
Qty per Tube	100
Small box (inner) Dimenaion	525*132*60mm
Max qty per small box	5,000
Large box (Outer) Dimenaion	530*290*335mm
Max qty per large box	50,000

SOP type

Packing Information	
Packing type	Reel type
Tape Width	16mm
Qty per Reel	2,000
Small box (inner) Dimenaion	345*345*60mm
Max qty per small box	4,000
Large box (Outer) Dimenaion	620x360x360mm
Max qty per large box	40,000

(2)Packing Label Sample



1. MTL NO:Contents with "Order Information" in the specification.
2. LOT NO:The production cycle of the product.
3. BATCH:The CTR RANK of the product.
4. Quantity:Product packaging quantity.
5. Product Data: The data when product be made.

13. Reliability Test

NO.	Item	Condition	Quantity	Cycle	Reference Standards
1	RSH, Resistance to Solder Heat	260±5°C,20s/cycle	22	3 cycles	JESC22A-106
2	SD, Solderability	260±5°C, 10s/cycle	22	1 cycle	JESD22-B102
3	TC, Temperature Cycle	H: 125°C 15min ∫ 5min L: -55°C 15min	77	300cycles	JESC22A-104
4	TS, Thermal Shock	H:100°C 5min ∫ 15s L:-10°C 5min	77	300cysles	JESC22A-106
5	LTSL, Low Temperature Storage	T:-55°C	77	1000h	JESD22-A119
6	HTSL, High Temperature Storage	T:125°C	77	1000h	JESC22A-103
7	THB, High Temperature High Humidity	T:85°C RH: 85%	77	1000h	JESC22A-101
8	HTOL DC Operating Life	T: 110°C IF=10mA VCC=5V	77	1000h	MIL-STD-750 Method 1037
9	ESD-HBM Human Body Model ESD	Ta=25° C, Reference JESD22-A114	6	1 cycle	JESD22-A114

14. Temperature Profile Of Soldering

(1).IR Reflow soldering (JEDEC-STD-020C compliant)

One time soldering reflow is recommended within the condition of temperature and time profile shown below. Do not solder more than three times.

Profile item	Conditions
Preheat	
- Temperature Min (T Smin)	150°C
- Temperature Max (T Smax)	200°C
- Time (min to max) (ts)	90±30 sec
Soldering zone	
- Temperature (TL)	217°C
- Time (t L)	60 sec
Peak Temperature	260°C
Peak Temperature time	20 sec
Ramp-up rate	3°C / sec max.
Ramp-down rate from peak temperature	3~6°C / sec
Reflow times	≤3

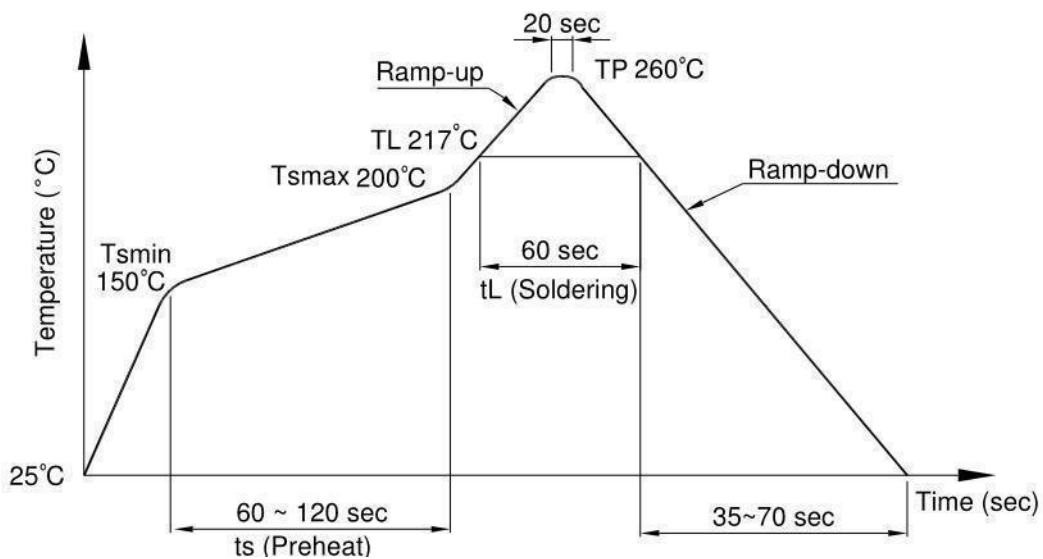

(2).Wave soldering (JEDEC22A111 compliant)

One time soldering is recommended within the condition of temperature.

Temperature	260+0/-5°C
Time	10 sec
Preheat temperature	25 to 140°C
Preheat time	30 to 80 sec

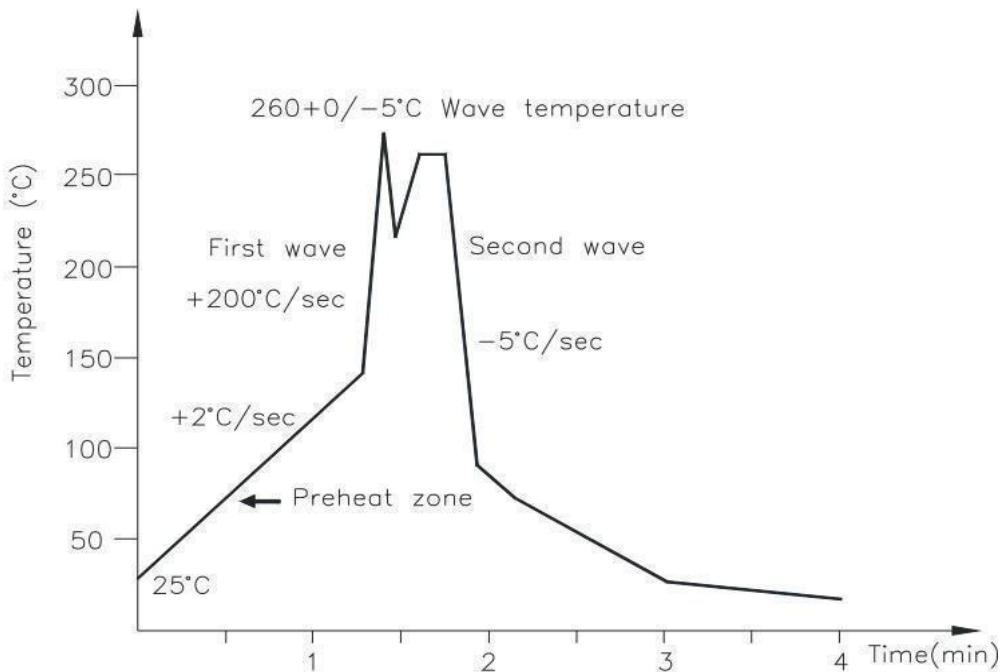

(3).Hand soldering by soldering iron

Allow single lead soldering in every single process. One time soldering is recommended.

Temperature	380+0/-5°C
Time	3 sec max

15. Characteristics Curves

Fig.1 Forward Current vs. Ambient Temperature

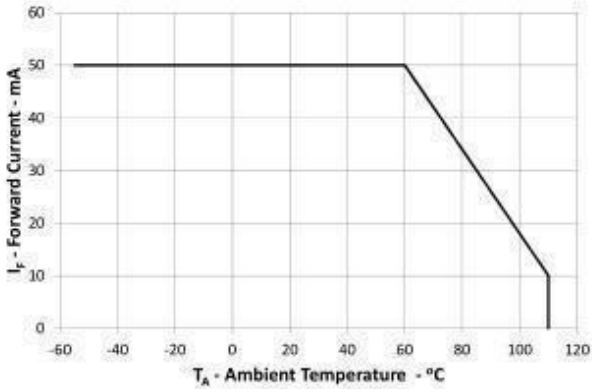

Fig.2 Collector Power Dissipation vs. Ambient Temperature

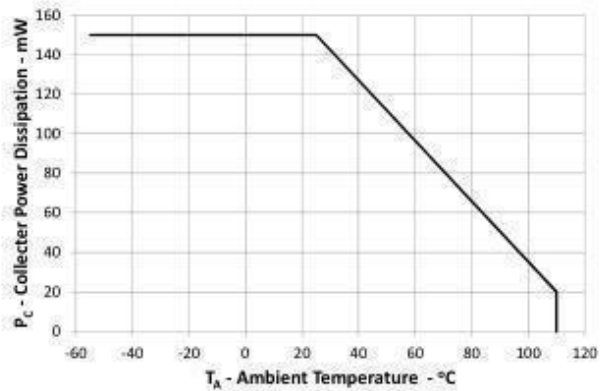

Fig.3 Collector-emitter Saturation Voltage vs. Forward Current

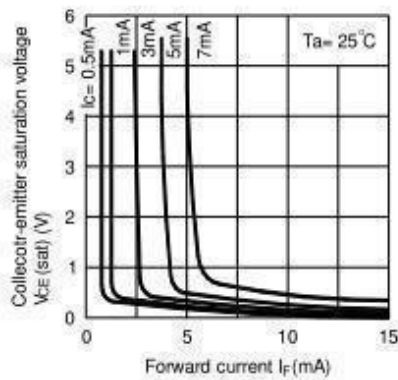

Fig.4 Forward Current vs. Forward Voltage

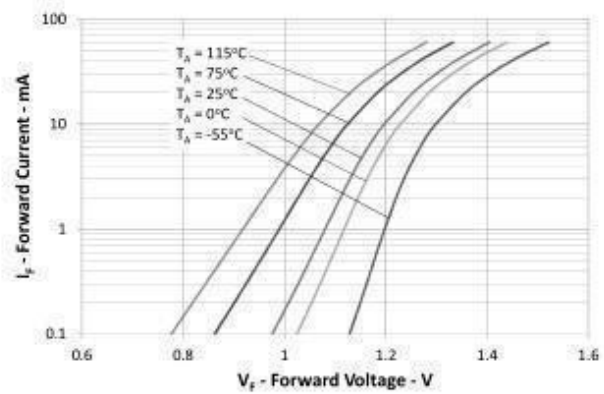

Fig.5 Current Transfer Ratio vs. Forward Current

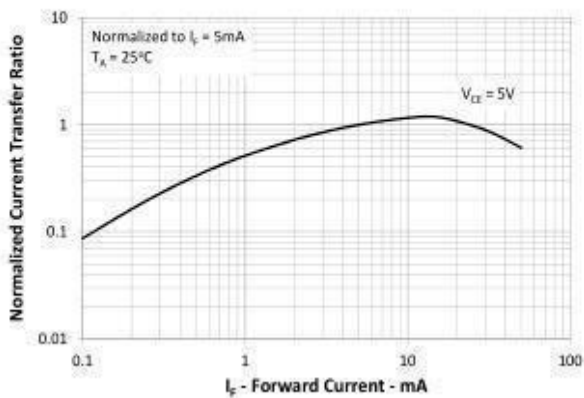

Fig.6 Collector Current vs. Collector-emitter Voltage

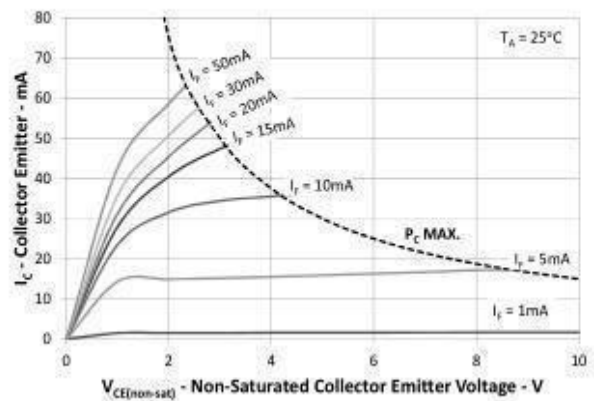

Fig.7 Relative Current Transfer Ratio vs. Ambient Temperature

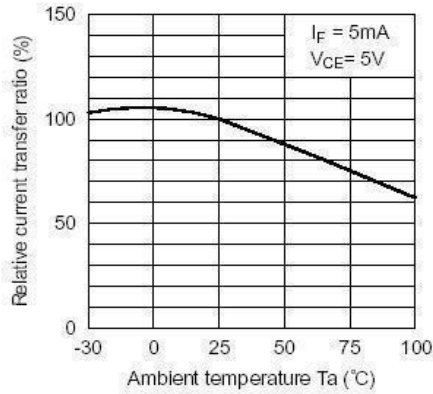

Fig.8 Collector-emitter Saturation Voltage vs. Ambient Temperature

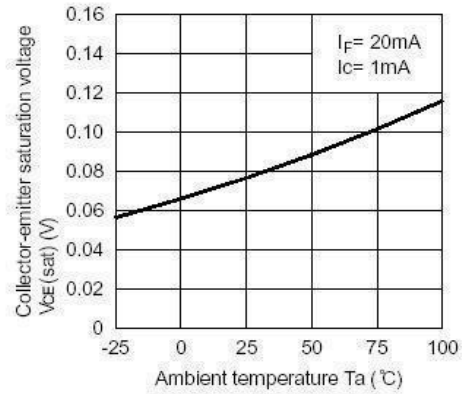

Fig.9 Collector Dark Current vs. Ambient Temperature

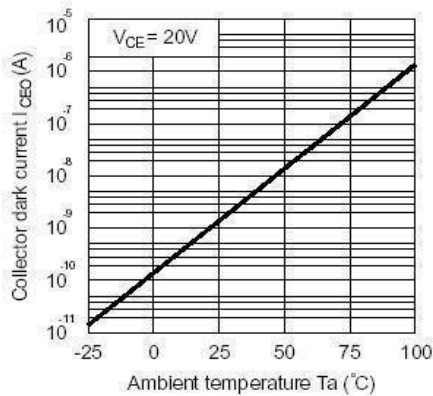

Fig.10 Response Time vs. Load Resistance

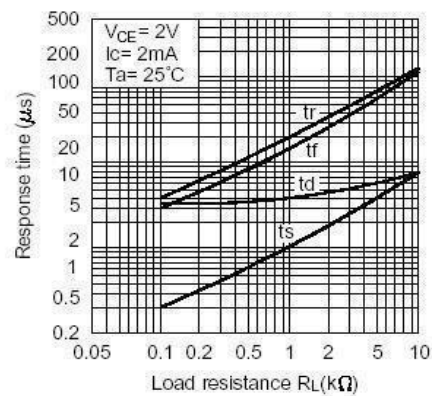
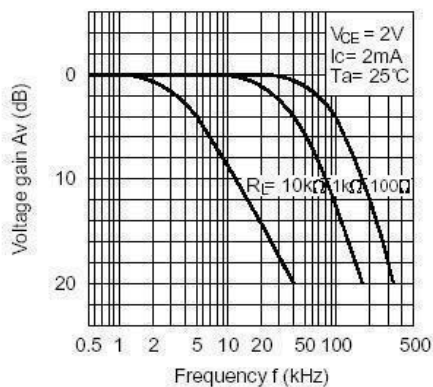
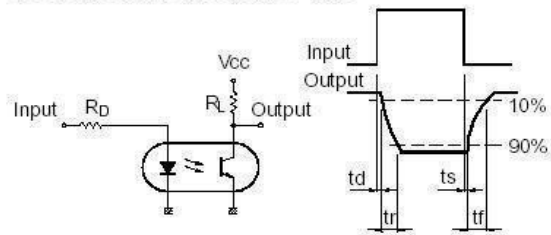

Fig.11 Frequency Response



Test Circuit for Response Time



Test Circuit for Frequency Response

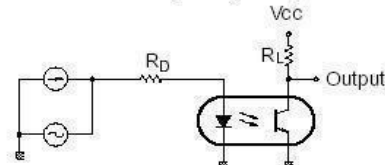

X-ON Electronics

Largest Supplier of Electrical and Electronic Components

Click to view similar products for [Photodiode Output Optocouplers](#) category:

Click to view products by [Orient](#) manufacturer:

Other Similar products are found below :

[TLP590B\(C,F\)](#) [TLP5214\(D4.E\(O](#) [TLP7820\(A-LF4.E\(O](#) [IS281](#) [APV2111V](#) [APV1121SX](#) [APV2111VY](#) [TLP190B\(TPR,U,C,F\)](#)
[TLP3906\(TPL,E](#) [TLP591B\(C,F\)](#) [IS281GR](#) [APS1241S](#) [APS2241S](#) [APV1122AJ](#) [APV1122J](#) [APV2121SJ](#) [APV2121S](#) [TLP3906\(TPR,E\(O](#)
[TLP3914\(TP15,F\)](#) [APV1121SJ](#) [NSL 32](#) [NSL-32SR3](#) [ASSR-V621-002E](#) [AQW214E2HAXL1](#) [QCPL-329J-500E](#) [TLP521-2XGBSMT&R](#)
[TLP521-2SMT&R](#) [K20102B](#) [TLD](#) [KPS28320E](#) [TLD](#) [CTH214A\(T1\)](#) [CT354\(V\)\(T1\)](#) [LTV-214-TP1-GR-G](#) [CTH217C\(V\)\(T1\)](#)
[CYMOC3023S\(TP1\)](#) [CYMOC3041S\(TP1\)](#) [CYMOC3061S\(TP1\)](#) [CYMOC3083S\(TP1\)](#) [CYPC356\(C-TP\)](#) [CYPS2501-1\(L-TP2\)](#)
[CYTLP127\(TP\)](#) [CYTLP291\(GB-TP\)](#) [KP10400E](#) [817B](#) [EL817M\(C\)-F](#) [K10103C](#) [KP40101C](#) [K30101A](#) [K30101C](#) [GX817MC](#) [ORPC-](#)
[817MB-F](#)