

OA92EC XC Series

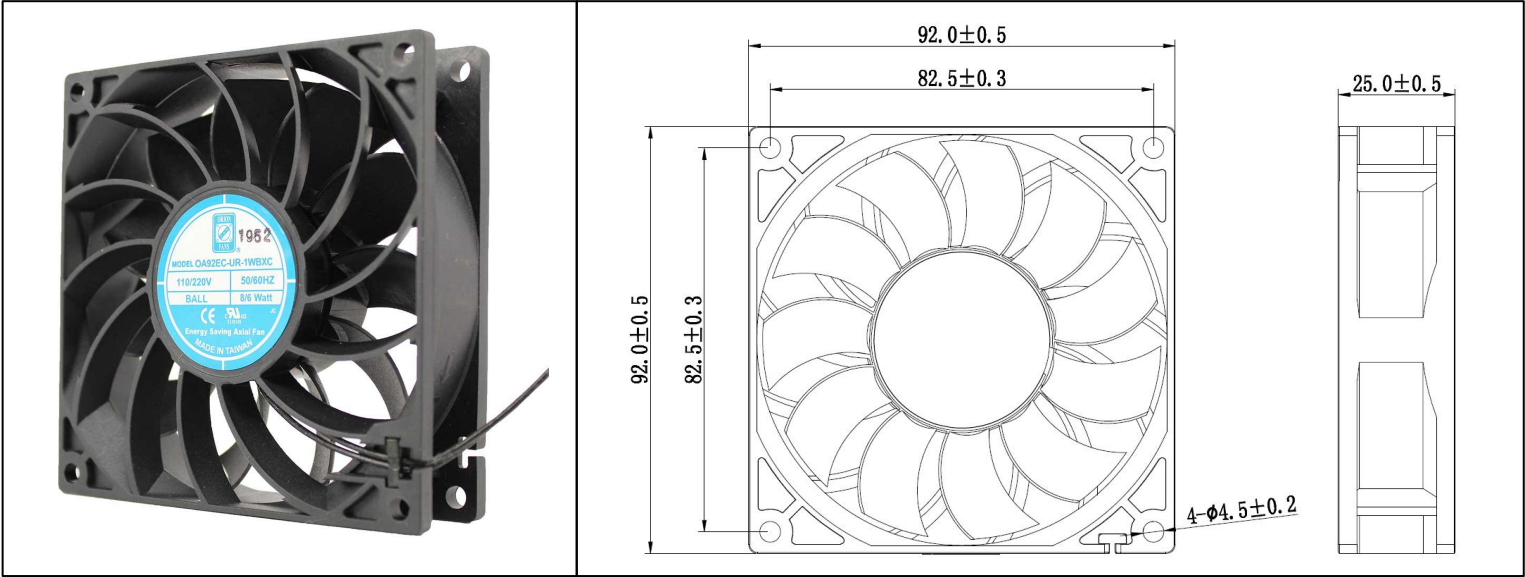

EC Fan Universal Voltage
92x25mm (3.62" x 0.98")



Frame	PBT UL94V0- Plastic	<u>Operating Temperature</u> -10C ~ +70C <u>Storage Temperature</u> -40C ~ +75C <u>Life Expectancy</u> 70,000 hours (L10 at 40C) Weight: ~ 0.22 lbs m0	
Impeller	PBT UL94V0- Plastic		
Connection	Wire Leads		
Motor	AC-DC Energy Saving, Electronically Protected		
Bearing System	Dual Ball Bearings		
Dielectric Strength	1500VAC/min		

Part Number	OA92EC-UR-1WBXC
Rated Voltage	110/220 VAC
Voltage Range	85 ~ 265
Rated Input	8 ~ 6 (4.0)W
Rated Speed (RPM)	2600
Airflow (CFM)	56
Noise Level (dB)	35
Max. Static Pressure	0.16"H ₂ O

X-ON Electronics

Largest Supplier of Electrical and Electronic Components

Click to view similar products for [EC Fans](#) category:

Click to view products by [Orion](#) manufacturer:

Other Similar products are found below :

[N43-45001](#) [ACi4400H](#) [ACi4400L](#) [3238.500](#) [3241.500](#) [CF4113MBL-000U-AE9](#) [ACi4400HH](#) [ACI4400MLR](#) [CF4113HBT-000U-ABD](#)
[AC4300H](#) [ACi4410HH](#) [ACi4420HH](#) [ACI4420ML](#) [W1G200-EF01-01](#) [W1G230-EB97-01](#) [W1G250-BB17-01](#) [W3G250-CD54-01](#) [W3G280-](#)
[EQ08-44](#) [W3G280-EQ20-43](#) [FMA1-06025WBHW12](#) [FMA1-08025WBHT12](#) [FMA1-08038WBHT12](#) [FMA1-09225WBHT12](#) [FMA1-](#)
[09225WBHW12](#) [FMA1-09238WBHT12](#) [FMA1-09238WBHW12](#) [FMA1-12025WBHT12](#) [FMA1-12025WBHW12](#) [FMA1-12038WBHT12](#)
[FMA1-12038WBHW12](#) [FMA1-12038WBJW12-A](#) [FMA1-17251WBHW32](#) [CF4113HBL-000U-AB9](#) [CF4113LBL-000U-AB9](#) [CF4113LBL-](#)
[000U-ABD](#) [CF4113MBL-000U-AB9](#) [CF4113MBL-000U-ABD](#) [W1G250-BB21-01](#) [W2G107-AD01-13](#) [W2G107-AD03-13](#) [W1G200-EA95-](#)
[68](#) [CF4113LBT-000U-A99](#) [CF4113MBL-000U-AA9](#) [CF4113MBT-000U-A99](#) [CF4113LBL-000U-AA9](#) [CF4113MBT-000U-AA9](#)
[CF4113LBT-000U-AA9](#) [CF4113MBT-000U-AB9](#) [CF4113MBL-000U-A99](#) [CF4113HBT-000U-AA9](#)