

◆ Features:

- ◇ High switching frequency
开关频率高
- ◇ Low forward voltage drop
正向压降低
- ◇ High efficiency and low power loss
高效低功耗
- ◇ High volume of current and good capability of surge current
大电流浪涌能力强

◆ Applications

- ◇ High frequency rectifier of switching mode power supplies
高频整流器开关电源
- ◇ Freewheeling diodes
续流二极管
- ◇ Polarity protection application
极性保护应用
- ◇ DC-DC converters
直流-直流变换器

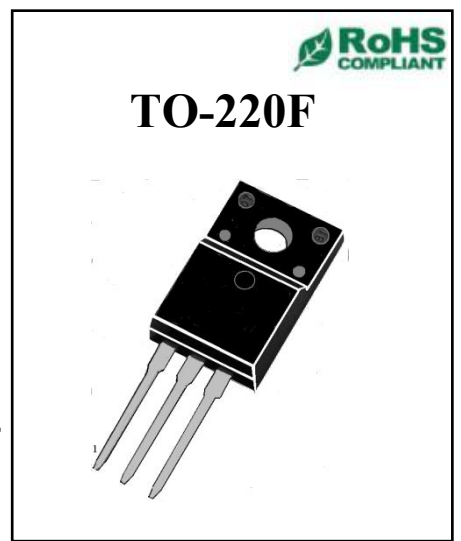
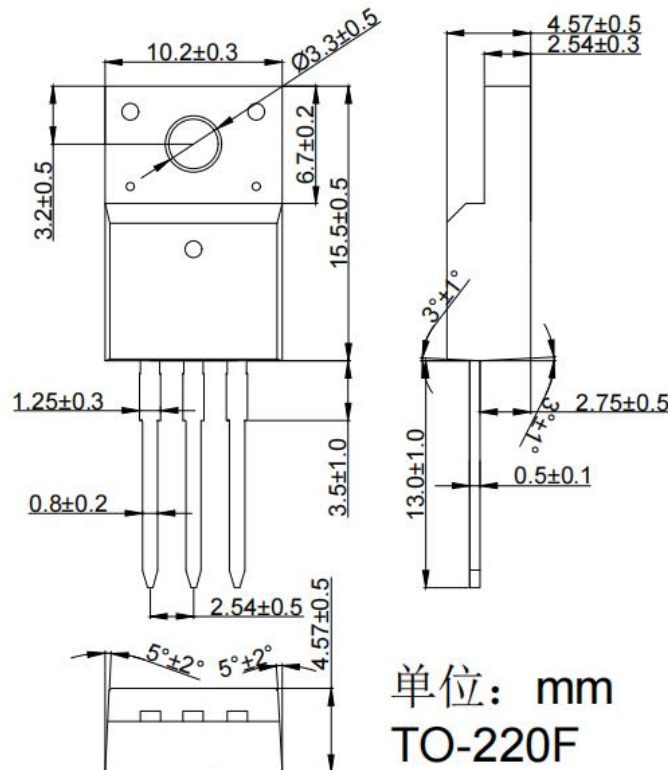
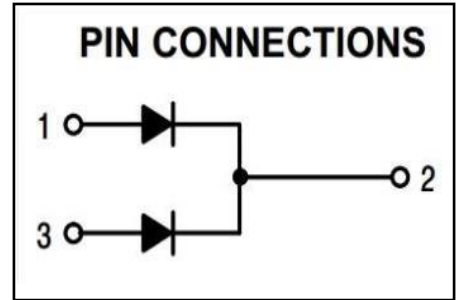

◆ Absolute Maximum Ratings (Tc=25°C)

Symbol	Parameters	Ratings	Unit
V _{RRM}	Repetitive Peak Reverse Voltage 最大反向重复峰值电压	150	V
V _{RWM}	Working peak reverse voltage 反向峰值工作电压	150	V
V _R	Maximum DC blocking voltage 最大直流反向电压	150	V
I _{F(AV)}	Maximum average forward rectified current Total device 最大正向平均电流	10	A
I _{FSM}	Peak Forward Surge Current 正向峰值浪涌电流	125	A
T _J	Operating junction temperature range 结温	175	°C
T _{stg}	Storage temperature range 贮存温度	-55~175	°C

◆ Electrical characteristics

Symbol	Parameters	Min	Typical	Max	Units	Conditions
I _R	Maximum Reverse Leakage Current (Note 1) 最大反向瞬态电流	--	--	5	uA	V _R =V _{RRM} T _C = 25 °C
V _F	Maximum Instantaneous Forward Voltage (Note 2) 最大瞬态正向压降	--	0.805	0.85	V	I _F = 5 A, T _C = 25 °C
R _{th(j-c)}	Typical Thermal Resistance, Junction to Case 结到外壳的典型热阻	--	--	3.15	°C/W	
dV/dt	Voltage Rate of Change 电压变化率	--	--	10000	V/μs	

Note 1: 2.0uS Pulse Width, f=1.0KHz

Note 2: Pulse Test : 300us Pulse Width, 1% Duty Cycle

X-ON Electronics

Largest Supplier of Electrical and Electronic Components

Click to view similar products for [Schottky Diodes & Rectifiers](#) category:

Click to view products by [OSEN](#) manufacturer:

Other Similar products are found below :

[MA4E2039](#) [MMBD301M3T5G](#) [HFA35HB60C](#) [RB160M-50TR](#) [D83C](#) [BAS16E6433HTMA1](#) [BAS 3010S-02LRH](#) [E6327](#) [BAT 54-02LRH](#)
[E6327](#) [NRVBAF360T3G](#) [NSR05F40QNXT5G](#) [NTE555](#) [JANS1N6640](#) [SS3003CH-TL-E](#) [GA01SHT18](#) [CRS10I30A\(TE85L,QM](#)
[MBRA140TRPBF](#) [MBRB30H30CT-1G](#) [BAT 15-04R](#) [E6152](#) [JANTX1N5712-1](#) [DMJ3940-000](#) [SB007-03C-TB-E](#) [NRVBB20100CTT4G](#)
[NRVBM120LT1G](#) [NTSB30U100CT-1G](#) [CRG04\(T5L,TEMQ\)](#) [ACDBA1100LR-HF](#) [ACDBA1200-HF](#) [ACDBA240-HF](#) [ACDBA3100-HF](#)
[CDBQC0530L-HF](#) [ACDBA260LR-HF](#) [ACDBA1100-HF](#) [10BQ015-M3/5BT](#) [NRVBM120ET1G](#) [VSSB410S-M3/5BT](#) [1N5819T-G](#)
[PDS1040Q-13](#) [B160BQ-13-F](#) [SDM05U20CSP-7](#) [BAS 70-07](#) [E6433](#) [B140S1F-7](#) [HSM560Je3/TR13](#) [DDB2265-000](#) [ZHCS506QTA](#)
[HSM190Je3/TR13](#) [B330AF-13](#) [ACDBUC0230-HF](#) [SDM1U100S1F-7](#) [MBR10200CTF-G1](#) [CDLL5712](#)