

OSRAM GW J9LHS2.4M

Datasheet

Published by **ams-OSRAM AG**

Tobelbader Strasse 30, 8141 Premstaetten, Austria

Phone +43 3136 500-0

ams-osram.com

© All rights reserved



DURIS® E 5050

GW J9LHS2.4M

This 5050 RGBW device is the first 4-in-1 color package for general lighting applications from ams OSRAM. It features industry-compatible performance and form factor and promises outstanding reliability for customers. Each chip is individually controlled to enable high customization color options along with tight wavelength and color binning for excellent homogeneity.



Applications

- Ambient Lighting
- Entertainment
- Home & Building Automation
- Indoor Lighting
- Outdoor & Industrial Lighting
- Robotics

Features

- Package: Multi-color LED
- Typ. Radiation: 120° (Lambertian emitter)
- Color temperature: 3000K - 5700K
- CRI: 82 (min.)
- ESD: 2 kV acc. to ANSI/ESDA/JEDEC JS-001 (HBM, Class 2)
- Industry Standard: RoHS and REACH
- Luminous Intensity: typ. 15000 mcd @ 3000K

Ordering Information

Type	Color temperature	Ordering Code
GW J9LHS2.4M-C0C7-2+35+13+30AW-1	3000 K	Q65113A4660
GW J9LHS2.4M-C0C7-2+35+13+35AW-1	3500 K	Q65113A4656
GW J9LHS2.4M-C0C7-2+35+13+40AW-1	4000 K	Q65113A4657
GW J9LHS2.4M-C0C7-2+35+13+50AW-1	5000 K	Q65113A4658
GW J9LHS2.4M-C0C7-2+35+13+57AW-1	5700 K	Q65113A4659

Notes:

Standard Ordering Codes (Q-codes) will cover the entire wavelength, brightness and Vf specified in datasheet.

1. Wavelength: Customers will receive individual reels from any color bins specified in datasheet.
2. Brightness: Customers will receive individual reels from any brightness bins specified in datasheet.
3. Forward Voltage: Customer will receive individual reels from a single Vf bins specified in datasheet.

BIN Description

GW J9LHS2.4M-C0C7-2+35+13+30AW-1

Product name

Brightness bins

Red bins

Green bins

Blue bins

White CCT

One forward voltage group

Maximum Ratings

Parameter	Symbol		Values	Values	Values	Values
			● red	● green	● blue	● white
Operating Temperature	T_{op}	min.	-40 °C	-40 °C	-40 °C	-40 °C
		max.	85 °C	85 °C	85 °C	85 °C
Storage Temperature	T_{stg}	min.	-40 °C	-40 °C	-40 °C	-40 °C
		max.	100 °C	100 °C	100 °C	100 °C
Junction Temperature	T_j	max.	110 °C	110 °C	110 °C	110 °C
Forward Current $T_j = 25\text{ °C}$	I_F	min.	20 mA	20 mA	20 mA	20 mA
		max.	200 mA	180 mA	180 mA	200 mA
Surge Current $t \leq 10\ \mu\text{s}; D = 0.005;$ $T_j = 25\text{ °C}$	I_{FS}	max.	500 mA	400 mA	400 mA	240 mA
ESD withstand voltage acc. to ANSI/ESDA/ JEDEC JS-001 (HBM, Class 2)	V_{ESD}		2 kV	2 kV	2 kV	2 kV

Characteristics

$I_F = 100 \text{ mA}$; $T_J = 25 \text{ °C}$

Parameter	Symbol		Values	Values	Values	Values
			● red	● green	● blue	● white
Dominant Wave-length ¹⁾ $I_F = 100 \text{ mA}$	λ_{dom}	min.	619.0 nm	520.0 nm	460.0 nm	
		max.	624.0 nm	535.0 nm	475.0 nm	
Spectral Bandwidth at 50% $I_{\text{rel,max}}$	$\Delta\lambda$	typ.	15.0 nm	29.0 nm	21.0 nm	
Viewing angle at 50% I_V	2ϕ	typ.	120 °	120 °	120 °	120 °
Forward Voltage ²⁾ $I_F = 100 \text{ mA}$	V_F	min.	2.00 V	2.70 V	2.70 V	2.70 V
		typ.	2.10 V	3.00 V	3.10 V	2.90 V
		max.	2.70 V	3.80 V	3.80 V	3.80 V
Color Rendering Index ³⁾	CRI	min.				82
Electrical thermal resistance junction/solderpoint with efficiency	$R_{\text{thJS elec.}}$	typ.	10 K / W	56 K / W	41 K / W	17 K / W

Notes:

1. The product is not designed for reverse operation.
2. Efficiency of each color: Red 42%; Blue 23%; Green 37%; White 40%

Brightness Groups

Color of emission	Group	Luminous Intensity ⁴⁾ $I_F = 100 \text{ mA}$ min. I_v	Luminous Intensity. ⁴⁾ $I_F = 100 \text{ mA}$ max. I_v
● red	C3	4500 mcd	6500 mcd
● red	C4	6500 mcd	8500 mcd
● red	C5	8500 mcd	10500 mcd
● green	C5	8500 mcd	10500 mcd
● green	C6	10500 mcd	14000 mcd
● green	C7	14000 mcd	17500 mcd
● blue	C0	1800 mcd	2500 mcd
● blue	C1	2500 mcd	3500 mcd
● blue	C2	3500 mcd	4500 mcd
● white	C5	8500 mcd	10500 mcd
● white	C6	10500 mcd	14000 mcd
● white	C7	14000 mcd	17500 mcd

Forward Voltage Groups

- red

Group	Forward Voltage ²⁾ $I_F = 100 \text{ mA}$ min. V_F	Forward Voltage ²⁾ $I_F = 100 \text{ mA}$ max. V_F
A1	2.00 V	2.70 V

Forward Voltage Groups

- green

Group	Forward Voltage ²⁾ $I_F = 100 \text{ mA}$ min. V_F	Forward Voltage ²⁾ $I_F = 100 \text{ mA}$ max. V_F
B1	2.70 V	3.80 V

Forward Voltage Groups

- blue

Group	Forward Voltage ²⁾ $I_F = 100 \text{ mA}$ min. V_F	Forward Voltage ²⁾ $I_F = 100 \text{ mA}$ max. V_F
B1	2.70 V	3.80 V

Forward Voltage Groups

- white

Group	Forward Voltage ²⁾ $I_F = 100 \text{ mA}$ min. V_F	Forward Voltage ²⁾ $I_F = 100 \text{ mA}$ max. V_F
B1	2.70 V	3.80 V

Wavelength Groups

- red

Group	Dominant Wavelength ¹⁾ $I_F = 100 \text{ mA}$ min. λ_{dom}	Dominant Wavelength ¹⁾ $I_F = 100 \text{ mA}$ max. λ_{dom}
2	619.0 nm	624.0 nm

Wavelength Groups

- green

Group	Dominant Wavelength ¹⁾ $I_F = 100 \text{ mA}$ min. λ_{dom}	Dominant Wavelength ¹⁾ $I_F = 100 \text{ mA}$ max. λ_{dom}
T3	520.0 nm	525.0 nm
T4	525.0 nm	530.0 nm
T5	530.0 nm	535.0 nm

Wavelength Groups

- blue

Group	Dominant Wavelength ¹⁾ $I_F = 100 \text{ mA}$ min. λ_{dom}	Dominant Wavelength ¹⁾ $I_F = 100 \text{ mA}$ max. λ_{dom}
B1	460.0 nm	465.0 nm
B2	465.0 nm	470.0 nm
B3	470.0 nm	475.0 nm

Chromaticity Coordinate Groups ⁵⁾

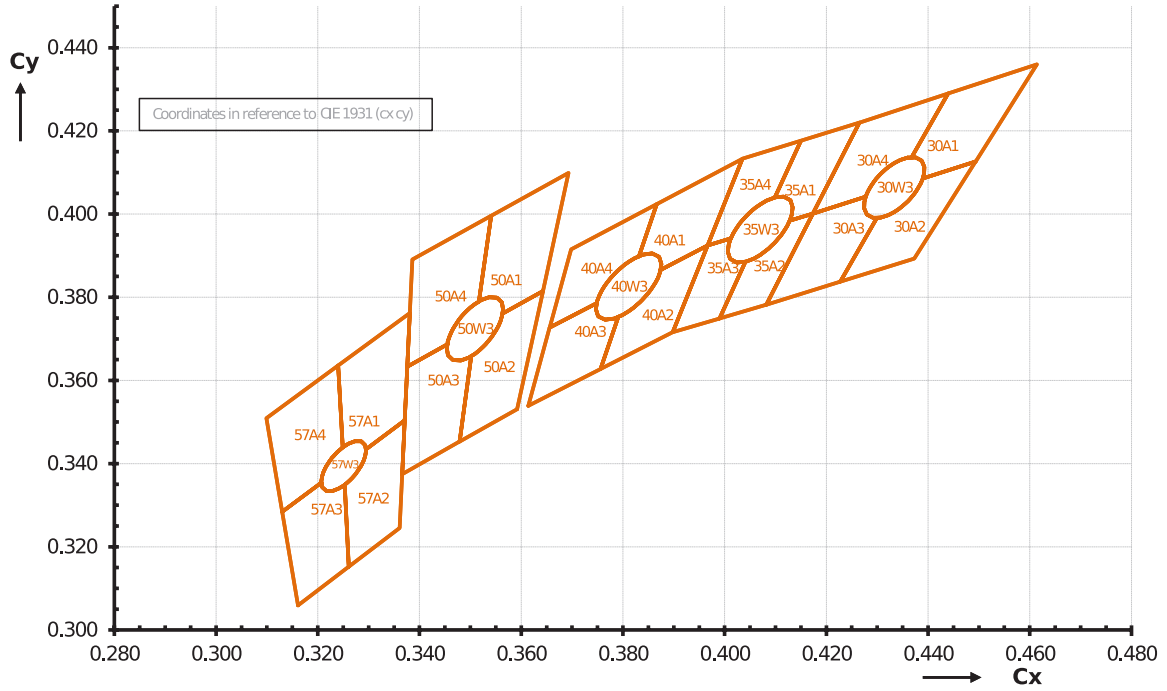

Chromaticity Coordinate Groups

CCT	Center Cx	Center Cy	3step a	3step b	5step a	5step b	∅
3000 K	0.4334	0.4064	0.0084	0.0041	0.014	0.0069	54.7
3500 K	0.4070	0.3963	0.0092	0.0042	0.0154	0.0069	54.6
4000 K	0.3811	0.3826	0.0093	0.0041	0.0155	0.0068	53.9
5000 K	0.3509	0.3724	0.0087	0.0038	0.0144	0.0064	59.1
5700 K	0.3251	0.3394	0.0069	0.003	0.0115	0.005	58.5

CCT	Group	1		2		3		4		5	
		Cx	Cy	Cx	Cy	Cx	Cy	Cx	Cy	Cx	Cy
3000 K	30A1	0.4440	0.4290	0.4614	0.4360	0.4494	0.4127	0.4390	0.4086	0.4367	0.4136
	30A2	0.4494	0.4127	0.4373	0.3893	0.4228	0.3838	0.4300	0.3991	0.4390	0.4086
	30A3	0.4228	0.3838	0.4082	0.3782	0.4174	0.4001	0.4278	0.4042	0.4300	0.3991
	30A4	0.4174	0.4001	0.4265	0.4220	0.4440	0.4290	0.4367	0.4136	0.4278	0.4042
3500 K	35A1	0.4150	0.4177	0.4265	0.4220	0.4174	0.4001	0.4128	0.3984	0.4099	0.4040
	35A2	0.4174	0.4001	0.4082	0.3782	0.3990	0.3749	0.4041	0.3885	0.4128	0.3984
	35A3	0.4070	0.4024	0.4061	0.4015	0.4054	0.4008	0.4048	0.4002	0.4041	0.3885
	35A4	0.3967	0.3925	0.4035	0.4133	0.4150	0.4177	0.4099	0.4040	0.4012	0.3941
4000 K	40A1	0.3867	0.4024	0.4035	0.4133	0.3967	0.3925	0.3874	0.3866	0.3831	0.3898
	40A2	0.3967	0.3925	0.3898	0.3716	0.3756	0.3628	0.3791	0.3753	0.3874	0.3866
	40A3	0.3756	0.3628	0.3614	0.3539	0.3656	0.3727	0.3749	0.3786	0.3791	0.3753
	40A4	0.3656	0.3727	0.3698	0.3915	0.3867	0.4024	0.3831	0.3898	0.3749	0.3786
5000 K	50A1	0.3541	0.3996	0.3693	0.4099	0.3643	0.3815	0.3563	0.3761	0.3517	0.3790
	50A2	0.3643	0.3815	0.3592	0.3531	0.3479	0.3453	0.3502	0.3659	0.3563	0.3761
	50A3	0.3479	0.3453	0.3366	0.3375	0.3376	0.3633	0.3455	0.3687	0.3502	0.3659
	50A4	0.3376	0.3633	0.3386	0.3891	0.3541	0.3996	0.3517	0.3790	0.3455	0.3687
5700 K	57A1	0.3240	0.3636	0.3381	0.3762	0.3371	0.3504	0.3295	0.3434	0.3249	0.3439
	57A2	0.3371	0.3504	0.3361	0.3245	0.3261	0.3152	0.3253	0.3349	0.3295	0.3434
	57A3	0.3261	0.3152	0.3161	0.3059	0.3130	0.3284	0.3207	0.3354	0.3253	0.3349
	57A4	0.3130	0.3284	0.3099	0.3509	0.3240	0.3636	0.3249	0.3439	0.3207	0.3354

Group Name on Label

Example: C3-2+C0-B1+C5-T3+C5-T3

Color	Brightness
● red	C3
● green	C5
● blue	C0
● white	C5

Relative Spectral Emission ⁶⁾

$I_{rel} = f(\lambda); I_F = 100 \text{ mA}; T_J = 25 \text{ }^\circ\text{C}$

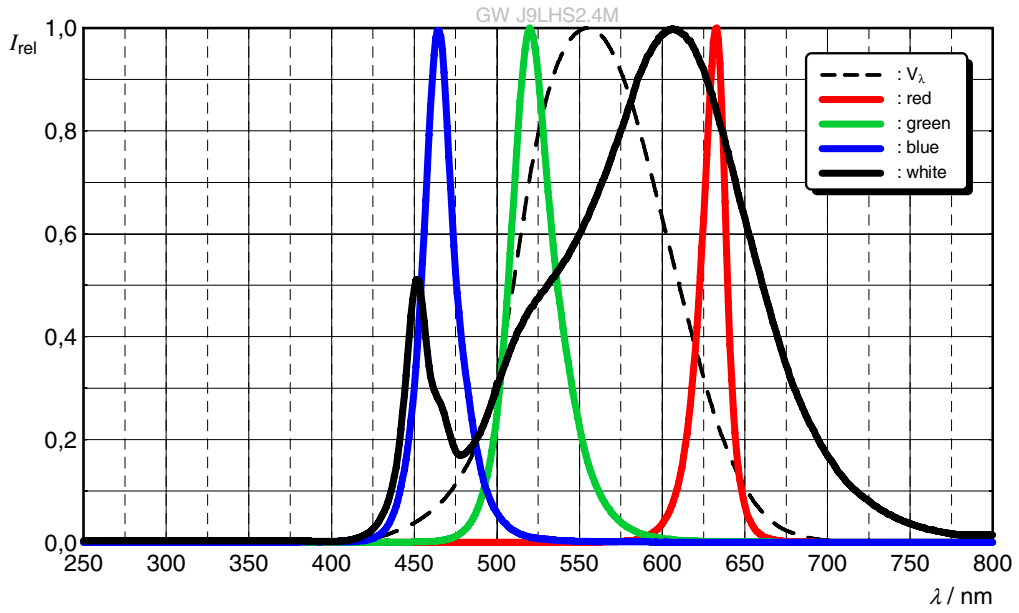

Radiation Characteristic (horizontal) ⁶⁾

$I_{rel} = f(\phi); T_J = 25 \text{ }^\circ\text{C}$

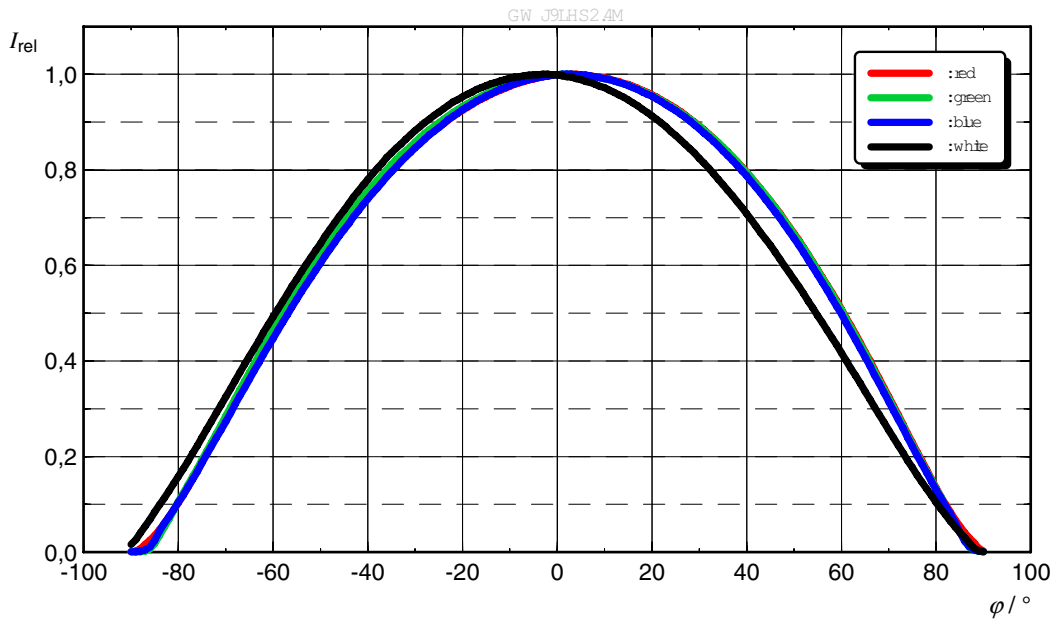

Radiation Characteristic (vertical) ⁶⁾

$I_{rel} = f(\phi)$; $T_J = 25\text{ °C}$

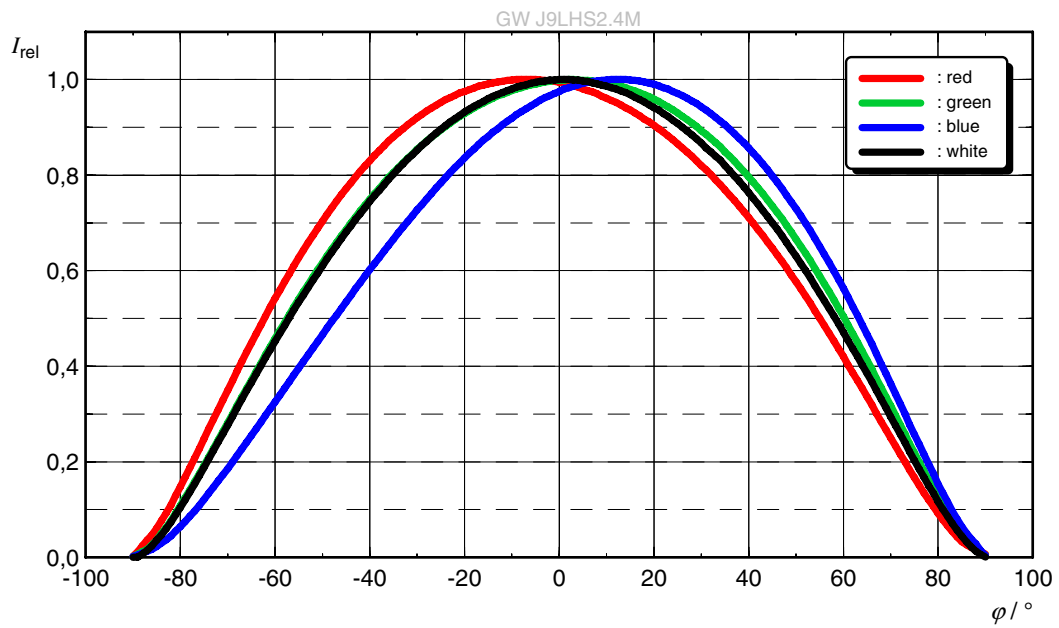

Forward current ⁶⁾

$$I_F = f(V_F); T_J = 25\text{ °C}$$

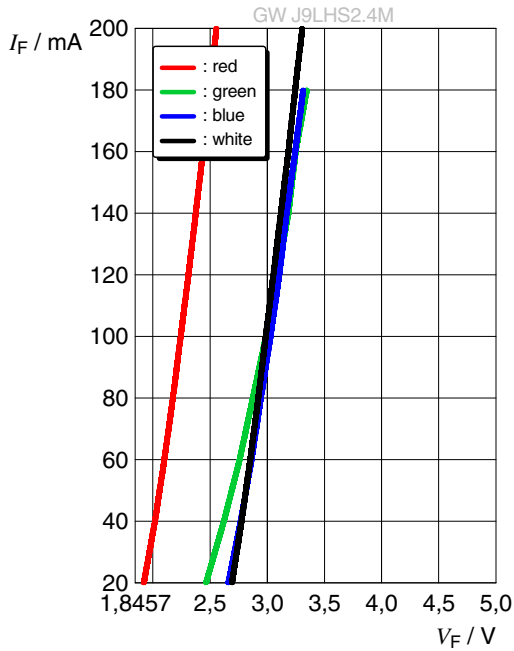

Relative Luminous Flux ^{6), 7)}

$$I_V / I_V(100 \text{ mA}) = f(I_F); T_J = 25\text{ °C}$$

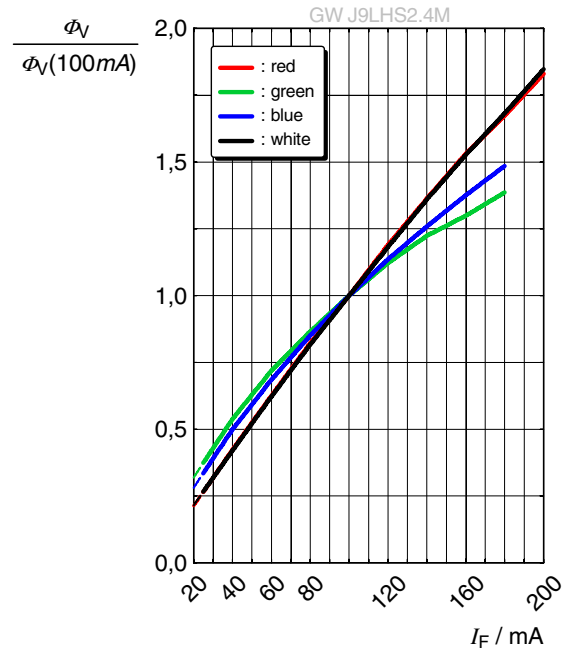

Chromaticity Coordinate Shift ⁶⁾

$$\Delta Cx, \Delta Cy = f(I_F); T_J = 25\text{ °C}$$

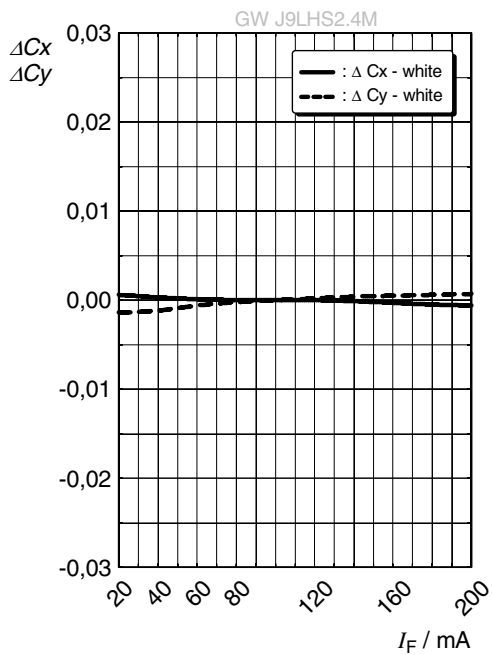

Dominant Wavelength ⁶⁾

$$\Delta \lambda_{\text{dom}} = f(I_F); T_J = 25\text{ °C}$$

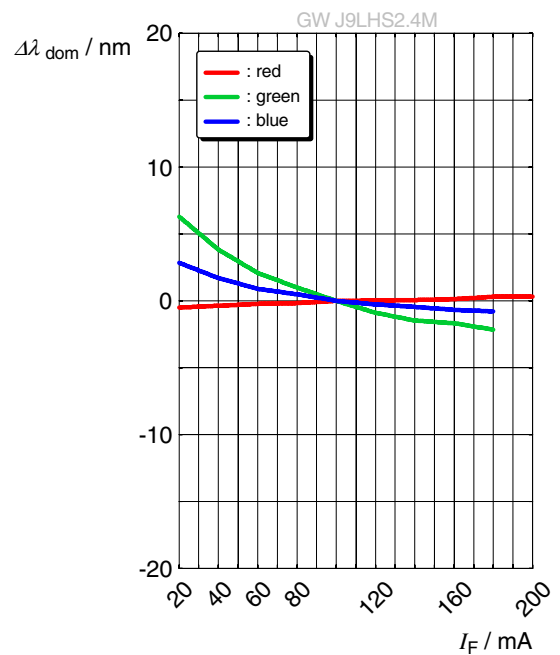

Forward Voltage ⁶⁾

$$\Delta V_F = V_F - V_F(25^\circ\text{C}) = f(T_j); I_F = 100\text{ mA}$$

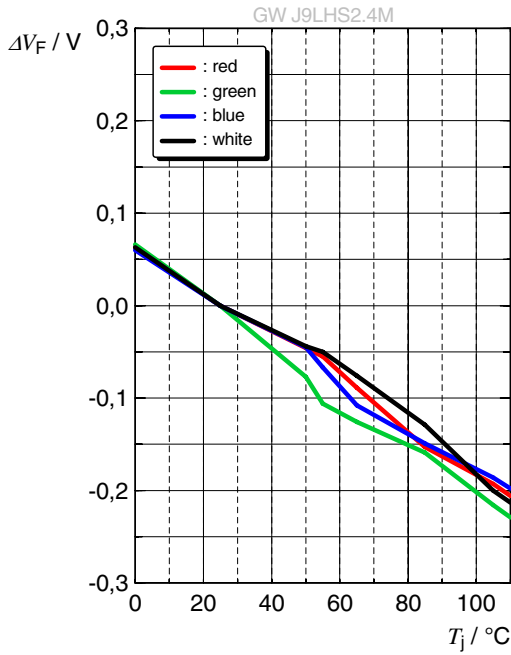

Relative Luminous Flux ⁶⁾

$$I_V / I_V(25^\circ\text{C}) = f(T_j); I_F = 100\text{ mA}$$

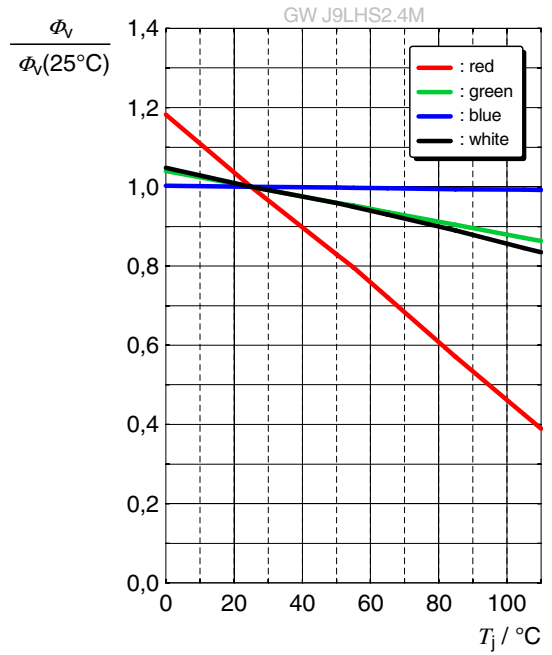

Chromaticity Coordinate Shift ⁶⁾

$$\Delta C_x, \Delta C_y = f(T_j); I_F = 100\text{ mA}$$

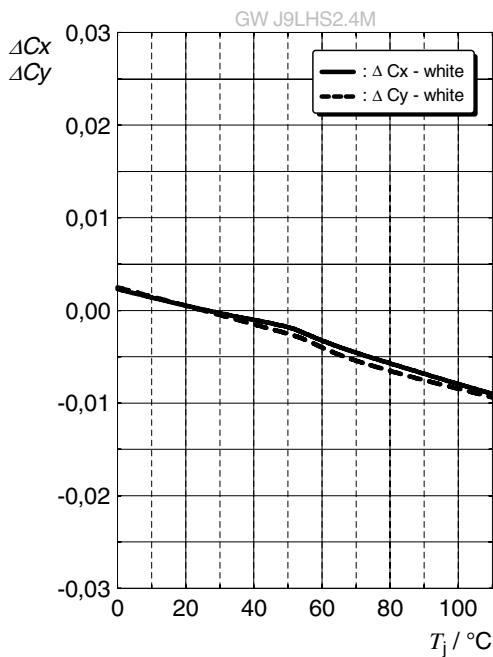

Dominant Wavelength ⁶⁾

$$\Delta \lambda_{\text{dom}} = \lambda_{\text{dom}} - \lambda_{\text{dom}}(25^\circ\text{C}) = f(T_j); I_F = 100\text{ mA}$$

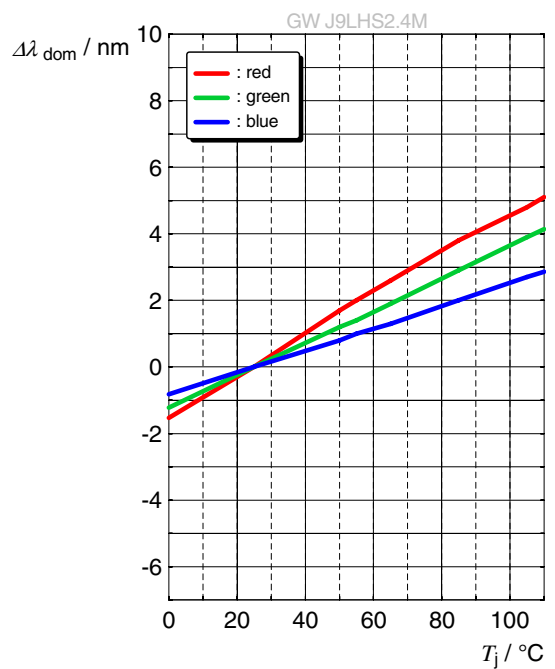

Max. Permissible Forward Current

$$I_F = f(T)$$

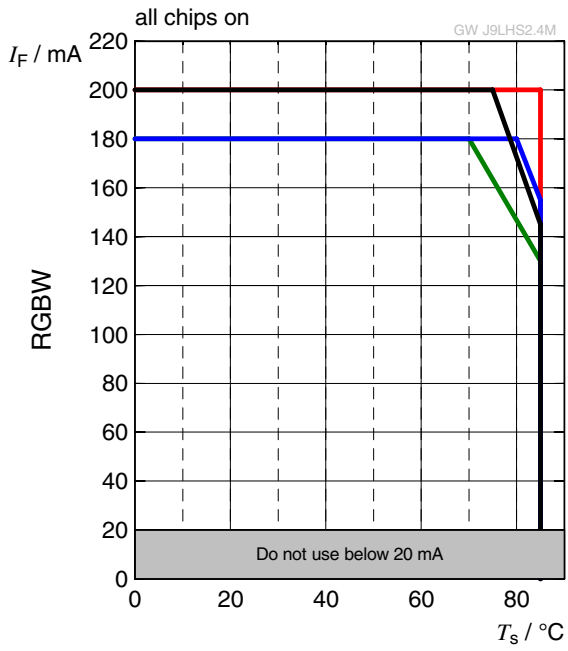

Dimensional Drawing ⁸⁾

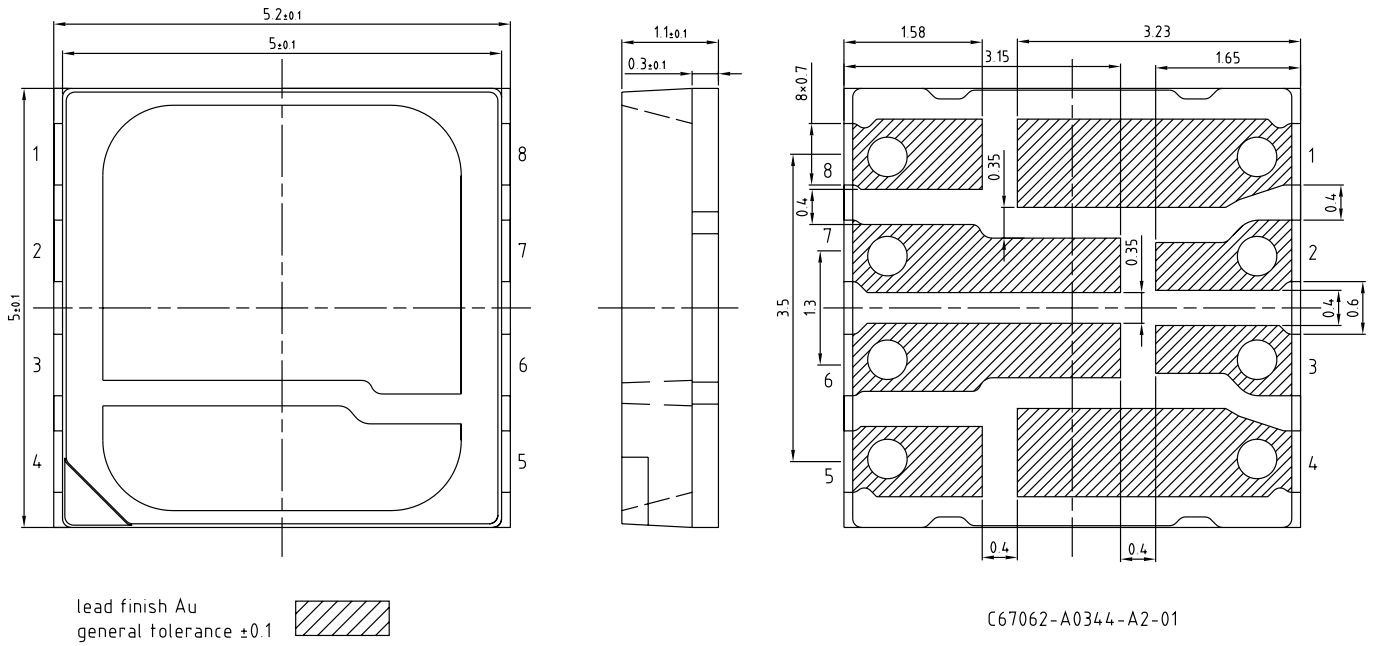

1	Anode Red (R)
8	Cathode Red (R)
2	Anode True Green (T)
7	Cathode True Green (T)
3	Anode Blue (B)
6	Cathode Blue (B)
4	Anode White (W)
5	Cathode White (W)

Further Information:

Approximate Weight: 73.0 mg

Package marking: Anode

Recommended Solder Pad ⁸⁾

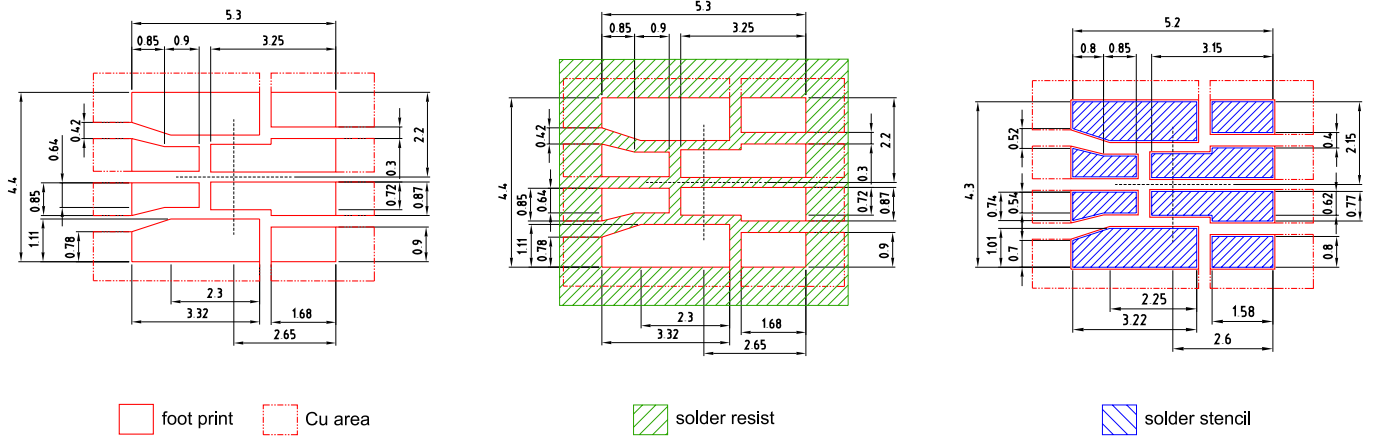

E067.0346.13-01

For superior solder joint connectivity results we recommend soldering under standard nitrogen atmosphere. Package not suitable for ultra sonic cleaning.

Reflow Soldering Profile

Product complies to MSL Level 3 acc. to JEDEC J-STD-020E

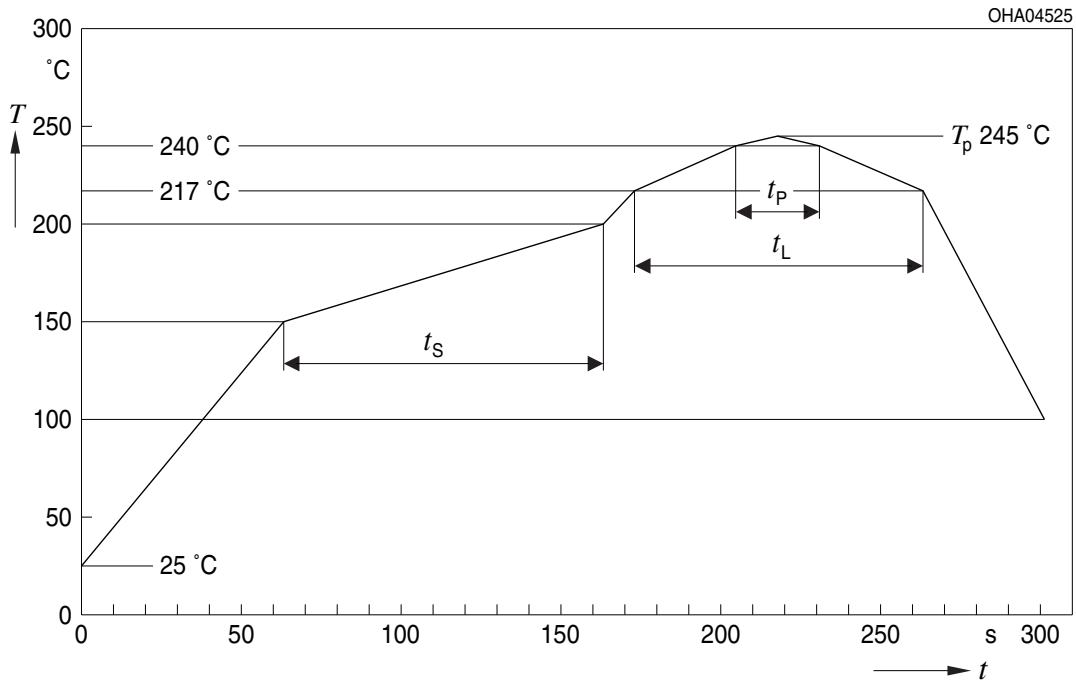

Profile Feature	Symbol	Pb-Free (SnAgCu) Assembly			Unit
		Minimum	Recommendation	Maximum	
Ramp-up rate to preheat ^{*)} 25 °C to 150 °C			2	3	K/s
Time t_s T_{Smin} to T_{Smax}	t_s	60	100	120	s
Ramp-up rate to peak ^{*)} T_{Smax} to T_p			2	3	K/s
Liquidus temperature	T_L		217		°C
Time above liquidus temperature	t_L		80	100	s
Peak temperature	T_p		245	250	°C
Time within 5 °C of the specified peak temperature $T_p - 5$ K	t_p	10	20	30	s
Ramp-down rate* T_p to 100 °C			3	4	K/s
Time 25 °C to T_p				480	s

All temperatures refer to the center of the package, measured on the top of the component

* slope calculation DT/Dt : Dt max. 5 s; fulfillment for the whole T-range

Taping ⁸⁾

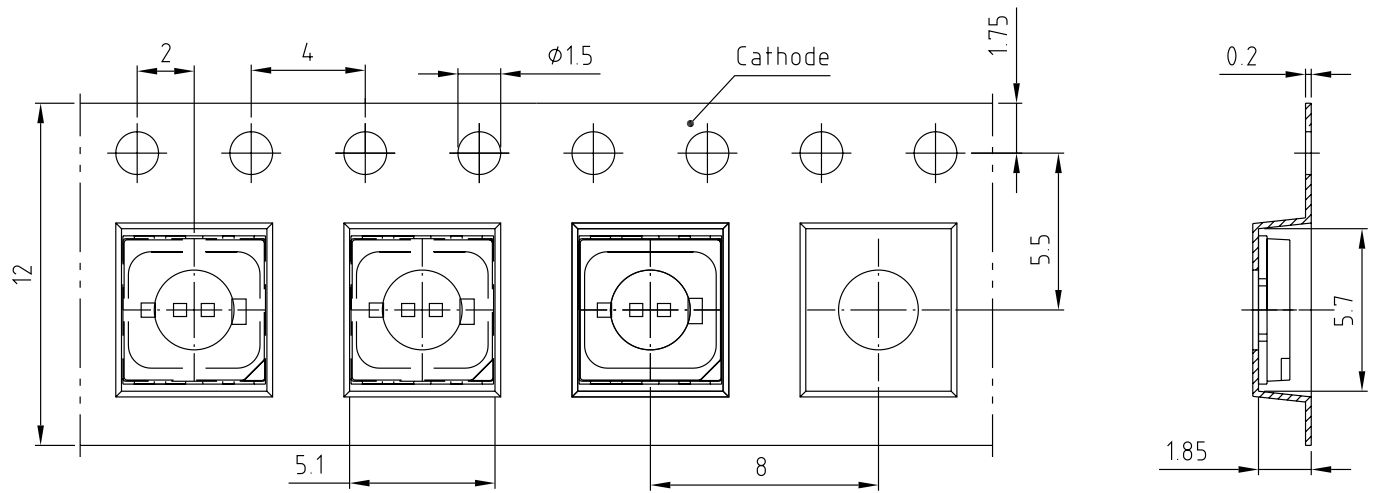

C67062-A0344-B2-01

Tape and Reel ⁹⁾

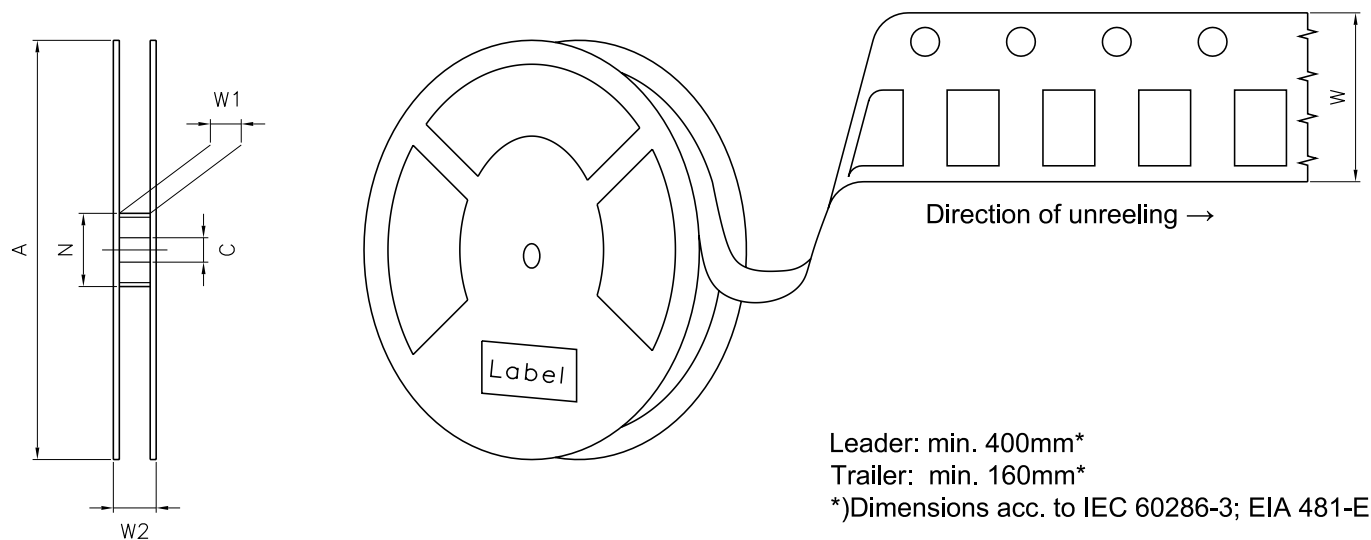

Reel Dimensions

A	W	N_{\min}	W_1	$W_{2\max}$	Pieces per PU
180 mm	$12 + 0.3 / - 0.1$ mm	60 mm	$12.4 + 2$ mm	18.4 mm	1000

Barcode-Product-Label (BPL)

OSRAM LX XXXX BIN1: XX-XX-X-XXX-X

RoHS Compliant



(6P) BATCH NO: 1234567890

(1T) LOT NO: 1234567890 (9D) D/C: 1234

(X) PROD NO: 123456789 (Q) QTY: 9999 (G) GROUP: XX-XX-X-X

ML Temp ST
X XXX °C X

Pack: RXX
DEMY XXX
X_X123_1234.1234 X



OHA04563

Dry Packing Process and Materials

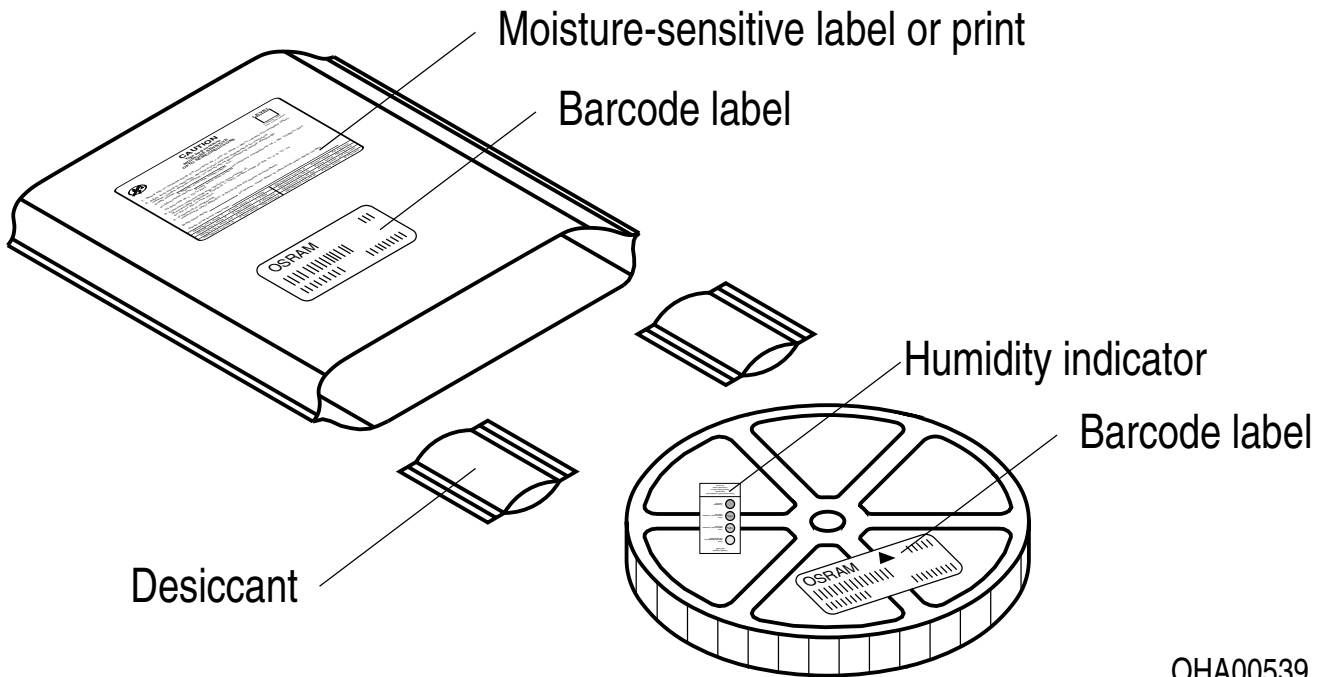

OHA00539

Notes

The evaluation of eye safety occurs according to the standard IEC 62471:2006 (photo biological safety of lamps and lamp systems). Within the risk grouping system of this IEC standard, the device specified in this data sheet fall into the class **moderate risk (exposure time 0.25 s)**. Under real circumstances (for exposure time, conditions of the eye pupils, observation distance), it is assumed that no endangerment to the eye exists from these devices. As a matter of principle, however, it should be mentioned that intense light sources have a high secondary exposure potential due to their blinding effect. When looking at bright light sources (e.g. headlights), temporary reduction in visual acuity and afterimages can occur, leading to irritation, annoyance, visual impairment, and even accidents, depending on the situation.

Subcomponents of this device contain, in addition to other substances, metal filled materials including silver. Metal filled materials can be affected by environments that contain traces of aggressive substances. Therefore, we recommend that customers minimize device exposure to aggressive substances during storage, production, and use. Devices that showed visible discoloration when tested using the described tests above did show no performance deviations within failure limits during the stated test duration. Respective failure limits are described in the IEC60810.

This device is designed for specific/recommended applications only. Please consult OSRAM Opto Semiconductors Sales Staff in advance for detailed information on other non-recommended applications (e.g. automotive).

Change management for this component is aligned with the requirements of the lighting market.

For further application related information please visit www.osram-os.com/appnotes

Disclaimer

Attention please!

The information describes the type of component and shall not be considered as assured characteristics. Terms of delivery and rights to change design reserved. Due to technical requirements components may contain dangerous substances.

For information on the types in question please contact our Sales Organization.

If printed or downloaded, please find the latest version on our website.

Packing

Please use the recycling operators known to you. We can also help you – get in touch with your nearest sales office. By agreement we will take packing material back, if it is sorted. You must bear the costs of transport. For packing material that is returned to us unsorted or which we are not obliged to accept, we shall have to invoice you for any costs incurred.

Product and functional safety devices/applications or medical devices/applications

Our components are not developed, constructed or tested for the application as safety relevant component or for the application in medical devices.

Our products are not qualified at module and system level for such application.

In case buyer – or customer supplied by buyer – considers using our components in product safety devices/ applications or medical devices/applications, buyer and/or customer has to inform our local sales partner immediately and we and buyer and /or customer will analyze and coordinate the customer-specific request between us and buyer and/or customer.

Glossary

- 1) **Wavelength:** The wavelength is measured at a current pulse of typically 10 ms, with a tolerance of ± 0.5 nm.
- 2) **Forward Voltage:** The Forward voltage is measured during a current pulse duration of typically 1 ms with a tolerance of $\pm 0.05V$.
- 3) **Color reproduction index:** Color reproduction index values (CRI-RA) are measured during a current pulse of typically 10 ms and with a tolerance of ± 2 . And CRI-R9 are measured during a current pulse of typically 10 ms and the 4000K with a tolerance of ± 6 .
- 4) **Brightness:** Brightness values are measured during a current pulse of typically 10 ms, with a tolerance of $\pm 7\%$.
- 5) **Chromaticity coordinate groups:** Chromaticity coordinate groups are measured during a current pulse duration of typically 10ms with a tolerance of ± 0.005 .
- 6) **Typical Values:** Due to the special conditions of the manufacturing processes of semiconductor devices, the typical data or calculated correlations of technical parameters can only reflect statistical figures. These do not necessarily correspond to the actual parameters of each single product, which could differ from the typical data and calculated correlations or the typical characteristic line. If requested, e.g. because of technical improvements, these typ. data will be changed without any further notice.
- 7) **Characteristic curve:** In the range where the line of the graph is broken, you must expect higher differences between single devices within one packing unit.
- 8) **Tolerance of Measure:** Unless otherwise noted in drawing, tolerances are specified with ± 0.1 and dimensions are specified in mm.
- 9) **Tape and Reel:** All dimensions and tolerances are specified acc. IEC 60286-3 and specified in mm.

Revision History

Version	Date	Change
1.0	2022-06-03	Initial Version
1.1	2022-09-15	Features Wavelength Groups
1.2	2023-02-24	Electro - Optical Characteristics (Diagrams)



EU RoHS and China RoHS compliant product

此产品符合欧盟 RoHS 指令的要求；
按照中国的相关法规和标准，
不含有毒有害物质或元素。

Published by ams-OSRAM AG

Tobelbader Strasse 30, 8141 Premstaetten, Austria

Phone +43 3136 500-0

ams-osram.com

© All rights reserved

am  **OSRAM**

X-ON Electronics

Largest Supplier of Electrical and Electronic Components

Click to view similar products for [High Power LEDs - Multi-Colour category](#):

Click to view products by [Osram manufacturer](#):

Other Similar products are found below :

[LZP-00MD00-0000](#) [LZP-L0MD00-0000_G2](#) [LL-HP60MV1L](#) [LL-HP60NUYC](#) [OSB4XME3E1E](#) [OSG5XDE5E1E](#) [OSR5XAE1E1E](#)
[OSR5XAE3E1E](#) [OSR5XME1E1E](#) [OSY5XAE1E1E](#) [OSY5XDE5E1E](#) [PK2N-3LGE-SD](#) [PK2N-3LRE-SD](#) [PQ2A-4FGE](#) [OSTCXBEAC1E](#)
[LZP-W0MD00-0000](#) [PM2E-1LAS](#) [PM2E-1LGS](#) [PM2E-3LAE-SD](#) [PM2E-3LAS-SD](#) [PM2E-3LBS-SD](#) [PM2E-3LGS-SD](#) [PM2E-3LRE-SD](#)
[PM2E-3LRS-SD](#) [PP6N-TFFE-D60](#) [PP6N-1LFE-P](#) [PK2N-3LLE-L](#) [OSG5XME1E1E](#) [OSR5XAT3C1E](#) [OSR5XME3E1E](#) [OSY5XME3E1E](#)
[PC8N-5L4E-C](#) [PK2N-3LBE-SD](#) [PM2B-1LPE-M](#) [PM2B-1LPS-M](#) [PQ2A-4FRE](#) [CLQ6B-TKW-S1L1R1H1TBB7935CC3](#) [CLQ6B-TKW-](#)
[S1L1R1H1TBB7935DD3](#) [CLQ6B-TKW-S1L1R1H1TBB7935BB3](#) [CLQ6B-TKW-S1L1R1H1TBB7935AA3](#) [CLW6A-TKW-](#)
[C90C070B0BB7C3CE73](#) [CLW6A-TKW-C90C070B0BB7C3CE53](#) [CLW6A-TKW-C90C070B0BB7C3CP53](#) [CLW6A-TKW-](#)
[C90C070B0BB7C3C523](#) [CLW6A-TKW-C90C070B0BB7C3CP33](#) [CLW6A-TKW-C90C070B0BB7C3CE83](#) [XMLDCL-00-R250-](#)
[00C5AAA02](#) [XMLDCL-00-R250-00C4AAAE5](#) [XMLDCL-00-R250-00C3AAAE7](#) [XMLDCL-00-0000-00C4AAAB1](#)