

# OSRAM LE B P0MQ

## Datasheet

Published by **ams-OSRAM AG**

Tobelbader Strasse 30, 8141 Premstaetten, Austria

Phone +43 3136 500-0

[ams-osram.com](http://ams-osram.com)

© All rights reserved



## OSRAM OSTAR® Projection Power

# LE B P0MQ

OSRAM OSTAR Projection Power is a high luminance LED for projection applications.

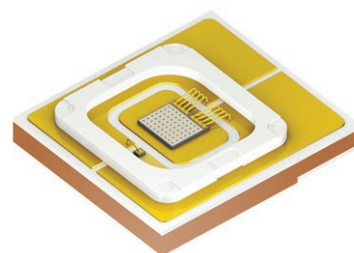

### Applications

- Projection & Display
- Visualization

### Features

- Package: OSTAR High Power Projection
- Chip technology: UX:3
- Typ. Radiation: 120° (Lambertian emitter)
- Color:  $\lambda_{\text{dom}} = 456 \text{ nm}$  (• blue)
- ESD: 2 kV acc. to ANSI/ESDA/JEDEC JS-001 (HBM, Class 2)

### Ordering Information

| Type              | Total radiant flux <sup>1)</sup><br>$I_F = 6000 \text{ mA}$<br>$\Phi_e$ | Ordering Code |
|-------------------|---|---------------|
| LE B P0MQ-DSEQ-23 | 5630 ... 8200 mW  | Q65113A0547   |

## Maximum Ratings

| Parameter  | Symbol                               |              | Values             |
|--|--------------------------------------|--------------|--------------------|
| Storage Temperature  | $T_{stg}$                            | min.<br>max. | -40 °C<br>100 °C   |
| Junction Temperature   | $T_j$                                | max.         | 150 °C             |
| Forward Current<br>$T_j = T_{j,max}$                                     | $I_F$                                | min.<br>max. | 200 mA<br>10000 mA |
| Forward Current pulsed<br>$D = 0.7; f = 240 \text{ Hz}; T_j = T_{j,max}$ | $I_{F \text{ pulse}}$                |              | 12000 mA           |
| Surge Current<br>$t_p \leq 50 \mu\text{s}; D = 0.1; T_j = T_{j,max}$     | $I_{FS}$                             | max.         | 14000 mA           |
| ESD withstand voltage<br>acc. to ANSI/ESDA/JEDEC JS-001 (HBM, Class 2)   | $V_{ESD}$                            |              | 2 kV               |
| Reverse current <sup>2)</sup>  | $I_R$                                | max.         | 200 mA             |
| Max. voltage difference anode-board, cathode-board                       | $ \Delta V_{a-b} ,  \Delta V_{c-b} $ | max.         | 40 V               |

## Characteristics

$T_{\text{Board}} = 25\text{ °C}$ ;  $I_{\text{F}} = 6000\text{ mA}$ ;  $f = 1000\text{ Hz}$ ;  $D = 0.25$

| Parameter  | Symbol                    | Values                          |
|--|---------------------------|---------------------------------|
| Peak Wavelength  | $\lambda_{\text{peak}}$   | typ. 450 nm                     |
| Dominant Wavelength <sup>3)</sup>  | $\lambda_{\text{dom}}$    | min. 452 nm                     |
|  |                           | typ. 456 nm                     |
|  |                           | max. 460 nm                     |
| Spectral bandwidth at 50% $I_{\text{rel,max}}$   | $\Delta\lambda$           | typ. 23 nm                      |
| Viewing angle at 50% $I_{\text{V}}$  | $2\phi$                   | typ. 120 °                      |
| Radiating surface  | $A_{\text{color}}$        | typ. 1.55 x 1.2 mm <sup>2</sup> |
| Partial Flux acc. CIE 127:2007 <sup>4)</sup><br>$I_{\text{F}} = 6000\text{ mA}$                | $\Phi_{\text{E/V, 120°}}$ | typ. 0.77                       |
| Forward Voltage <sup>5)</sup><br>$I_{\text{F}} = 6000\text{ mA}$                               | $V_{\text{F}}$            | min. 3.20 V                     |
|  |                           | typ. 3.50 V                     |
|  |                           | max. 3.80 V                     |
| Reverse voltage (ESD device)   | $V_{\text{R ESD}}$        | min. 45 V                       |
| Reverse voltage <sup>2)</sup><br>$I_{\text{R}} = 20\text{ mA}$                                 | $V_{\text{R}}$            | max. 1.2 V                      |
| Real thermal resistance junction/solderpoint   | $R_{\text{thJS real}}$    | typ. 1.6 K / W                  |
| Electrical thermal resistance junction/solderpoint<br>with efficiency $\eta_{\text{e}} = 31\%$ | $R_{\text{thJS elec.}}$   | typ. 1.1 K / W                  |

## Brightness Groups

| Group | Total radiant flux <sup>1)</sup><br>$I_F = 6000 \text{ mA}$<br>min.<br>$\Phi_e$ | Total radiant flux <sup>1)</sup><br>$I_F = 6000 \text{ mA}$<br>max.<br>$\Phi_e$ |
|-------|---|---|
| DS    | 5630 mW   | 6100 mW   |
| DT    | 6100 mW   | 6580 mW   |
| DU    | 6580 mW   | 7100 mW   |
| EP    | 7100 mW   | 7630 mW   |
| EQ    | 7630 mW   | 8200 mW   |

## Wavelength Groups

| Group | Dominant Wavelength <sup>3)</sup><br>min.<br>$\lambda_{\text{dom}}$ | Dominant Wavelength <sup>3)</sup><br>max.<br>$\lambda_{\text{dom}}$ |
|-------|---|---|
| 2     | 452 nm  | 456 nm  |
| 3     | 456 nm  | 460 nm  |

## Group Name on Label

### Example: DS-2

| Brightness | Wavelength |
|------------|------------|
| DS         | 2          |

### Relative Spectral Emission <sup>4)</sup>

$E_{rel} = f(\lambda); I_F = 6000 \text{ mA}; T_J = 25 \text{ }^\circ\text{C}$

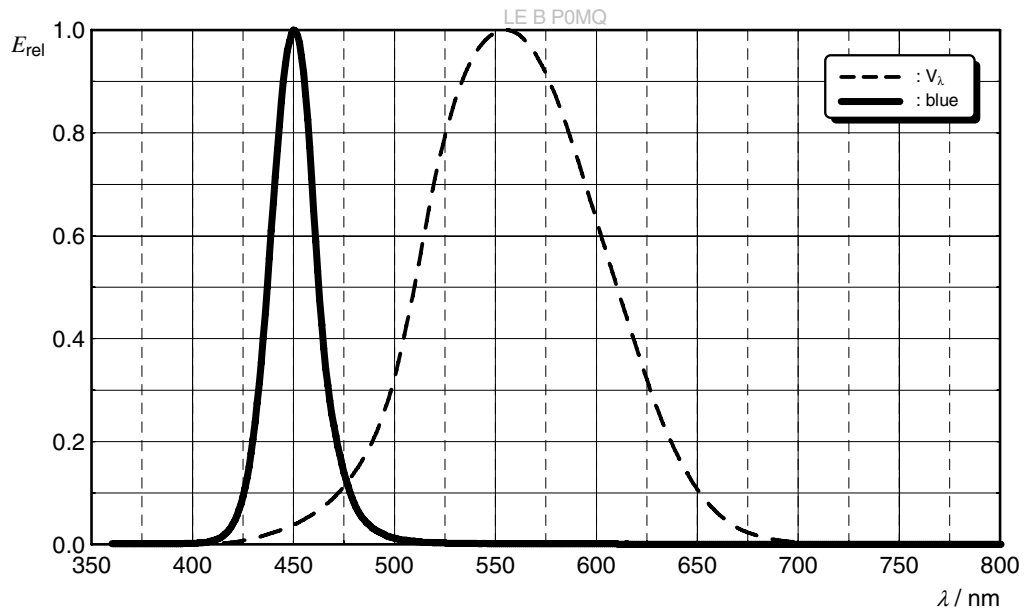

### Radiation Characteristics <sup>4)</sup>

$I_{rel} = f(\phi); T_J = 25 \text{ }^\circ\text{C}$

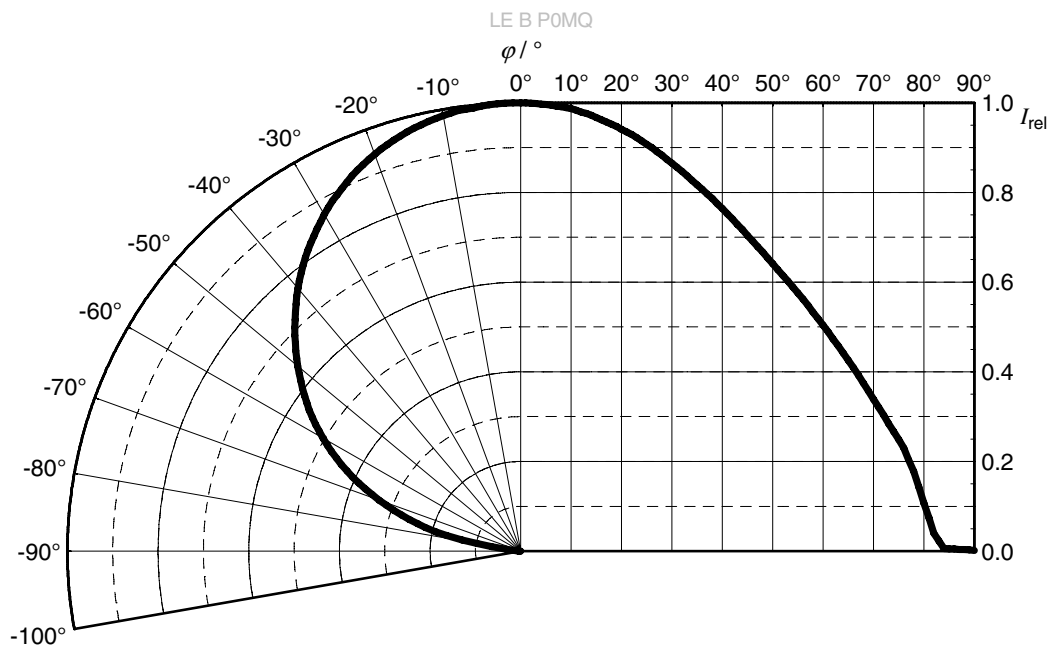

### Relative Partial Flux <sup>4)</sup>

$$\Phi_E(2\varphi)/\Phi_E(180^\circ) = f(\varphi); T_j = 25^\circ\text{C}$$

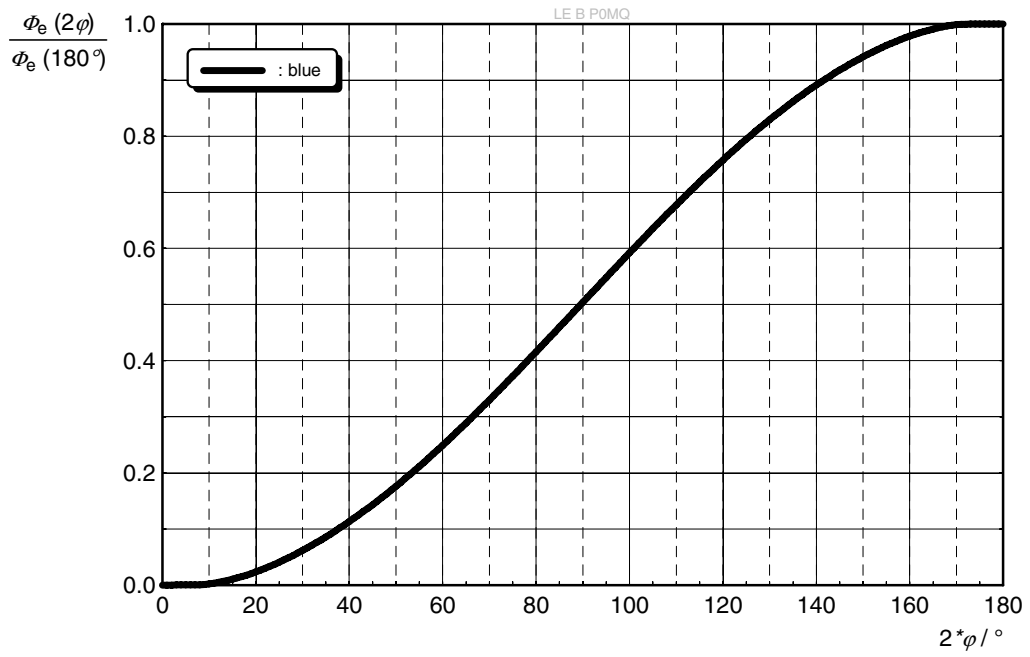

**Forward current** <sup>4)</sup>

$I_F = f(V_F); T_J = 25\text{ }^\circ\text{C}$

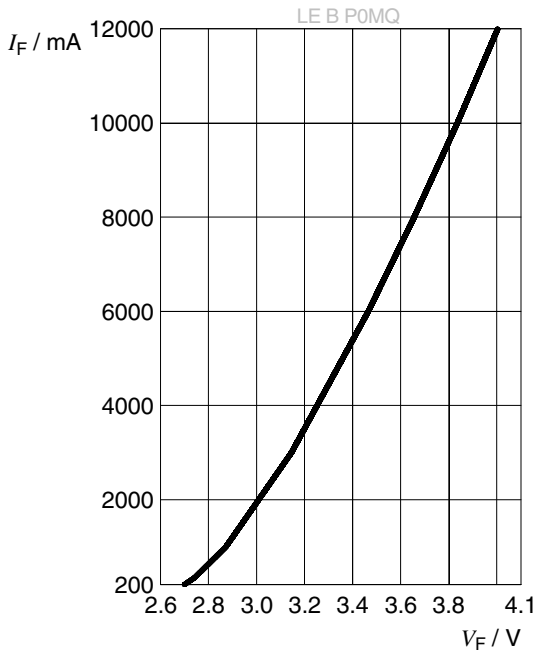

**Relative Radiant Power** <sup>4), 6)</sup>

$\Phi_E / \Phi_E(6000\text{ mA}) = f(I_F); T_J = 25\text{ }^\circ\text{C}$

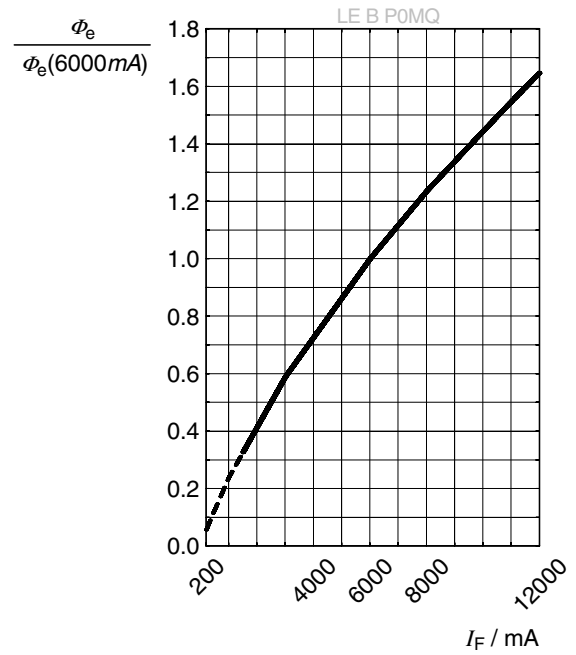

**Dominant Wavelength** <sup>4)</sup>

$\Delta\lambda_{\text{dom}} = f(I_F); T_J = 25\text{ }^\circ\text{C}$

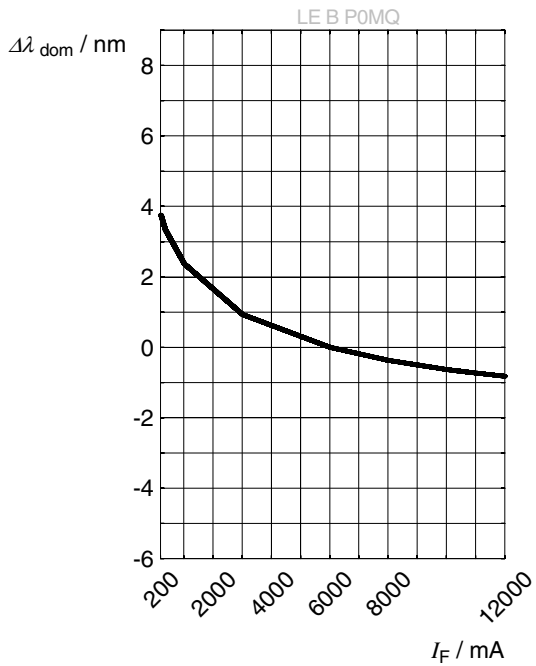



### Forward Voltage <sup>4)</sup>

$$\Delta V_F = V_F - V_F(25\text{ °C}) = f(T_j); I_F = 6000\text{ mA}$$

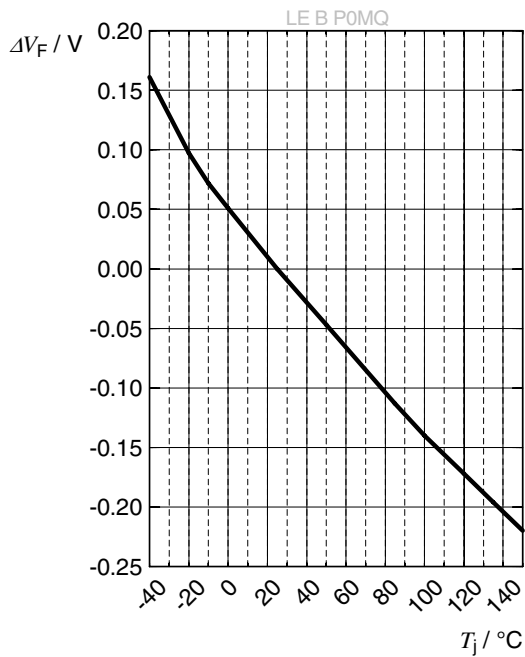

### Relative Radiant Power <sup>4)</sup>

$$\Phi_E / \Phi_E(25\text{ °C}) = f(T_j); I_F = 6000\text{ mA}$$

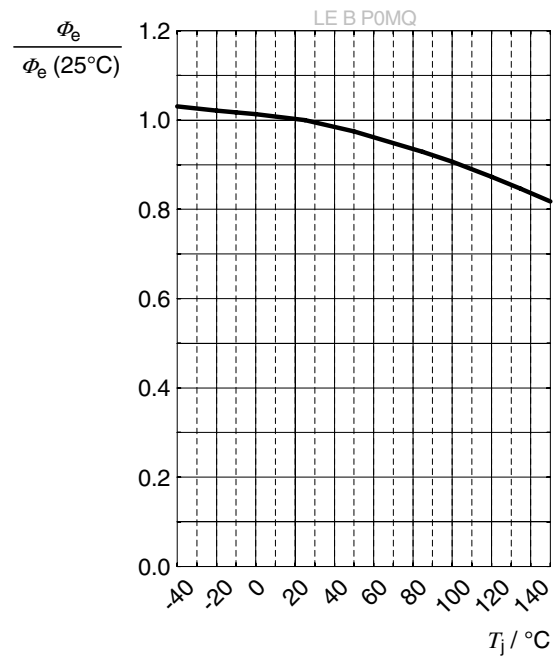

### Dominant Wavelength <sup>4)</sup>

$$\Delta \lambda_{\text{dom}} = \lambda_{\text{dom}} - \lambda_{\text{dom}}(25\text{ °C}) = f(T_j); I_F = 6000\text{ mA}$$

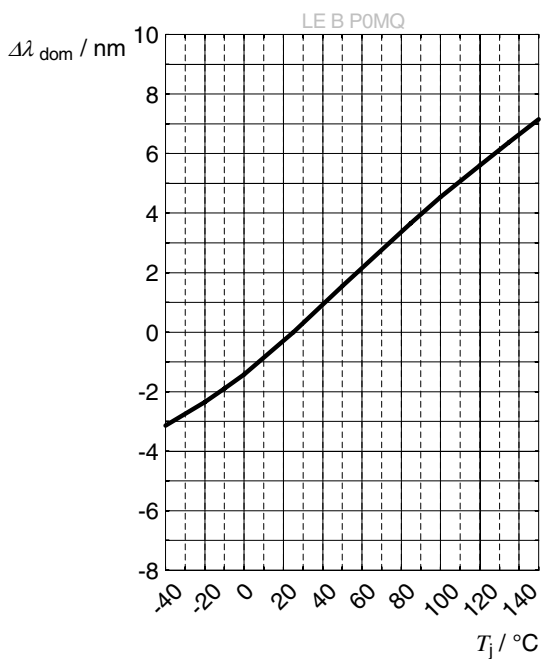

## Dimensional Drawing <sup>7)</sup>

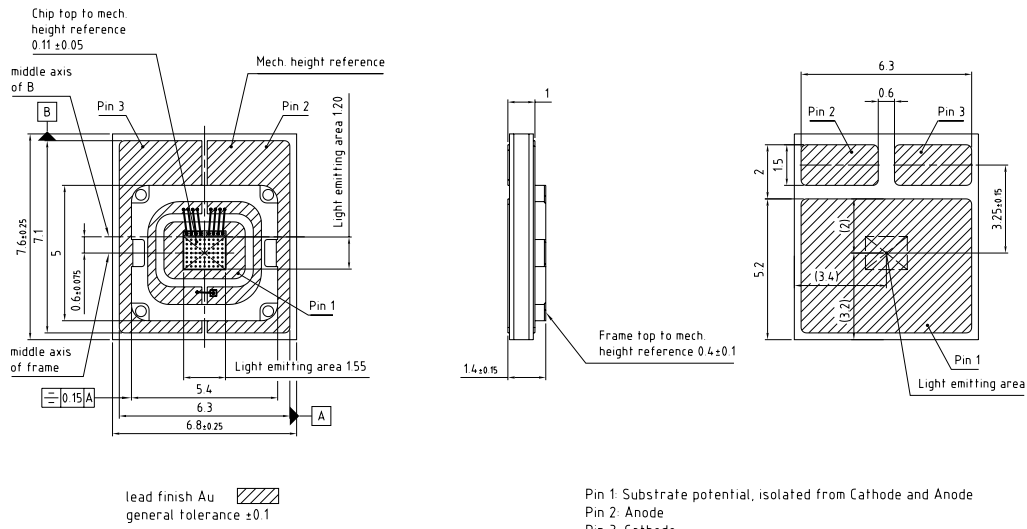

C63062-A4405-A2-04

## Further Information:

**Approximate Weight:** 380.0 mg

**ESD advice:** The device is protected by ESD device which is connected in parallel to the Chip.

**Notes:** Package not suitable for any kind of wet cleaning or ultrasonic cleaning.

Electrical Internal Circuit

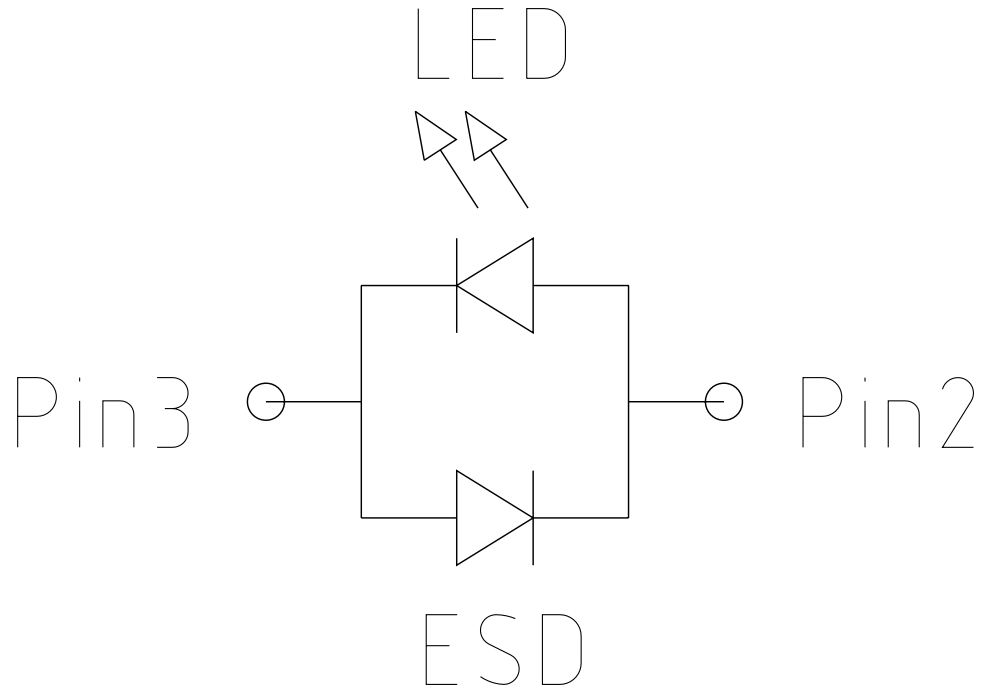

## Recommended Solder Pad <sup>7)</sup>

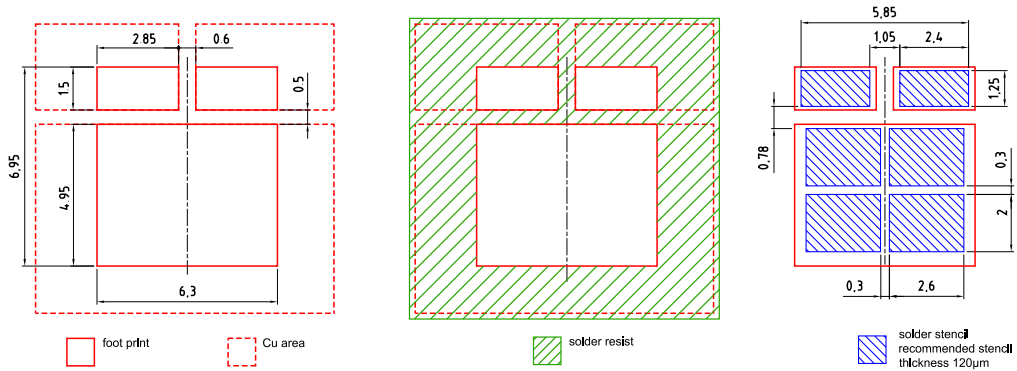

Component Location on Pad

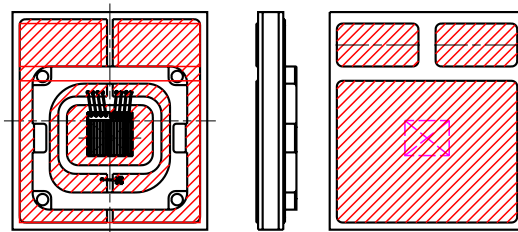

E062 3010.277 -03

For protection during reflow soldering and handling a foil is attached to the device. The foil has to be removed before operation. For superior solder joint connectivity results we recommend soldering under standard nitrogen atmosphere. To ensure a high solder joint reliability and to minimize the risk of solder joint cracks, the customer is responsible to evaluate the combination of PCB board and solder paste material for his application.

### Reflow Soldering Profile

Product complies to MSL Level 2 acc. to JEDEC J-STD-020E

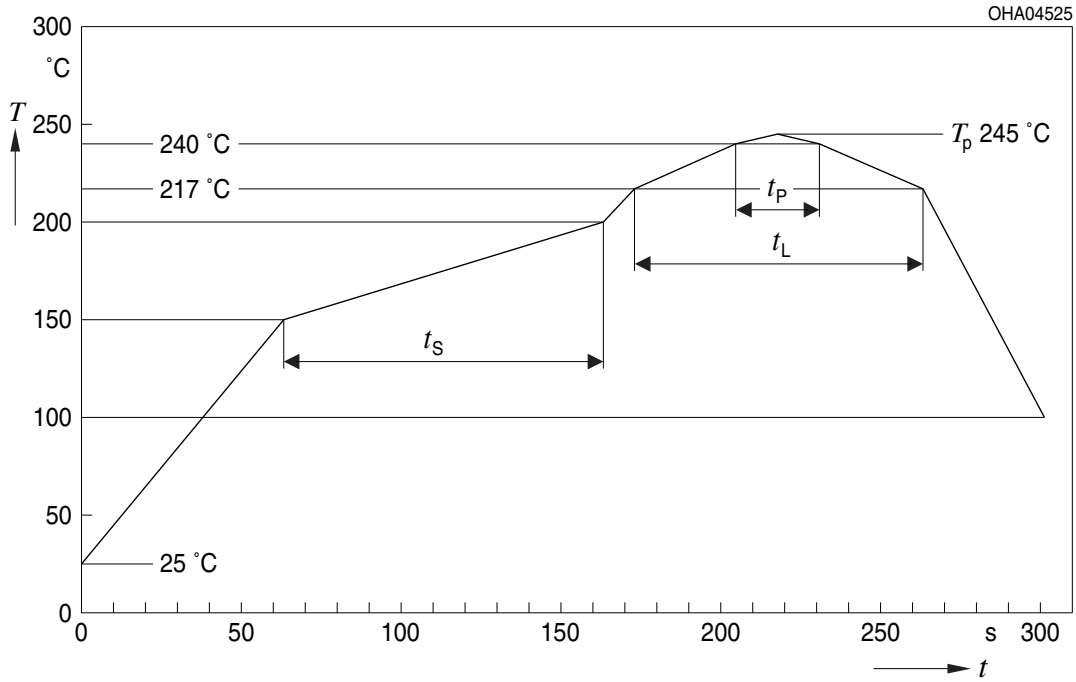

| Profile Feature  | Symbol | Pb-Free (SnAgCu) Assembly |                |         | Unit |
|--|--------|---------------------------|----------------|---------|------|
|  |        | Minimum                   | Recommendation | Maximum |      |
| Ramp-up rate to preheat <sup>*)</sup><br>25 °C to 150 °C       |        |                           | 2              | 3       | K/s  |
| Time $t_s$<br>$T_{Smin}$ to $T_{Smax}$                         | $t_s$  | 60                        | 100            | 120     | s    |
| Ramp-up rate to peak <sup>*)</sup><br>$T_{Smax}$ to $T_p$      |        |                           | 2              | 3       | K/s  |
| Liquidus temperature   | $T_L$  |                           | 217            |         | °C   |
| Time above liquidus temperature                                | $t_L$  |                           | 80             | 100     | s    |
| Peak temperature   | $T_p$  |                           | 245            | 260     | °C   |
| Time within 5 °C of the specified peak temperature $T_p - 5$ K | $t_p$  | 10                        | 20             | 30      | s    |
| Ramp-down rate*<br>$T_p$ to 100 °C                             |        |                           | 3              | 6       | K/s  |
| Time<br>25 °C to $T_p$   |        |                           |                | 480     | s    |

All temperatures refer to the center of the package, measured on the top of the component  
 \*) slope calculation  $DT/Dt$ :  $Dt$  max. 5 s; fulfillment for the whole T-range



Tape and Reel <sup>8)</sup>

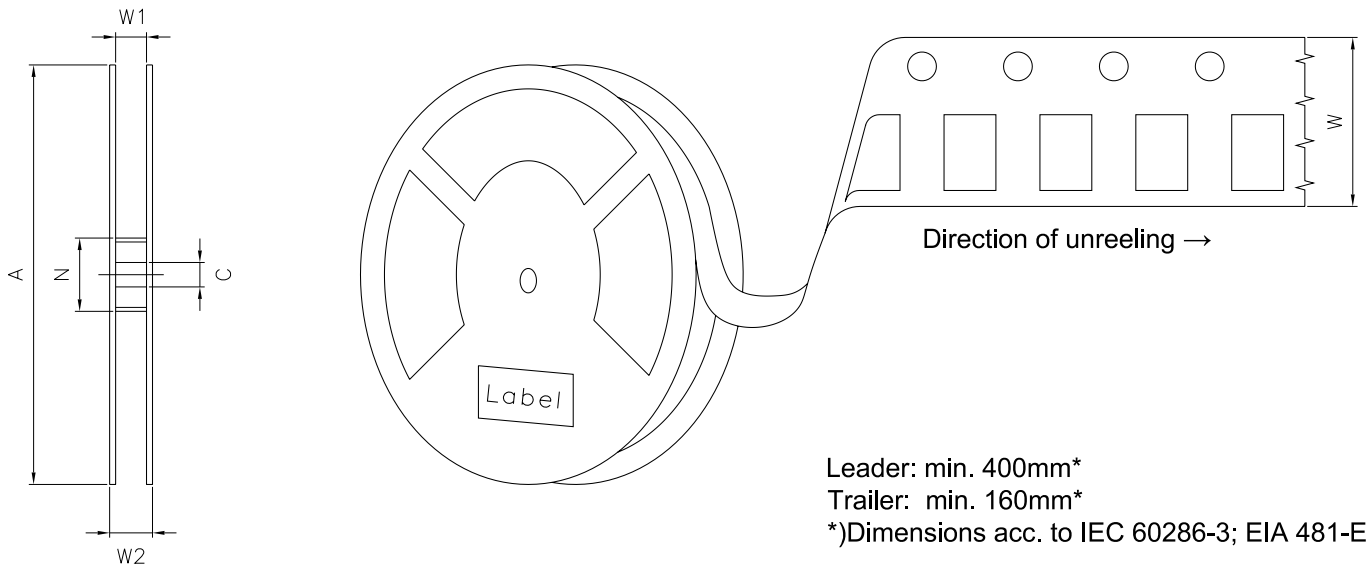

Reel Dimensions

| A      | W                   | N <sub>min</sub> | W <sub>1</sub> | W <sub>2 max</sub> | Pieces per PU |
|--------|---------------------|------------------|----------------|--------------------|---------------|
| 180 mm | 16 + 0.3 / - 0.1 mm | 60/100 mm        | 16.4 + 2 mm    | 22.4 mm            | 500           |

Barcode-Product-Label (BPL)

**OSRAM Opto Semiconductors** LX XXXX BIN1: XX-XX-X-XXX-X

RoHS Compliant





(6P) BATCH NO: 1234567890

(1T) LOT NO: 1234567890 (9D) D/C: 1234

(X) PROD NO: 123456789(Q)QTY: 9999 (G) GROUP: XX-XX-X-X

ML Temp ST  
X XXX °C X

Pack: RXX  
DEMY XXX  
X\_X123\_1234.1234 X



OHA04563



## Type Designation System

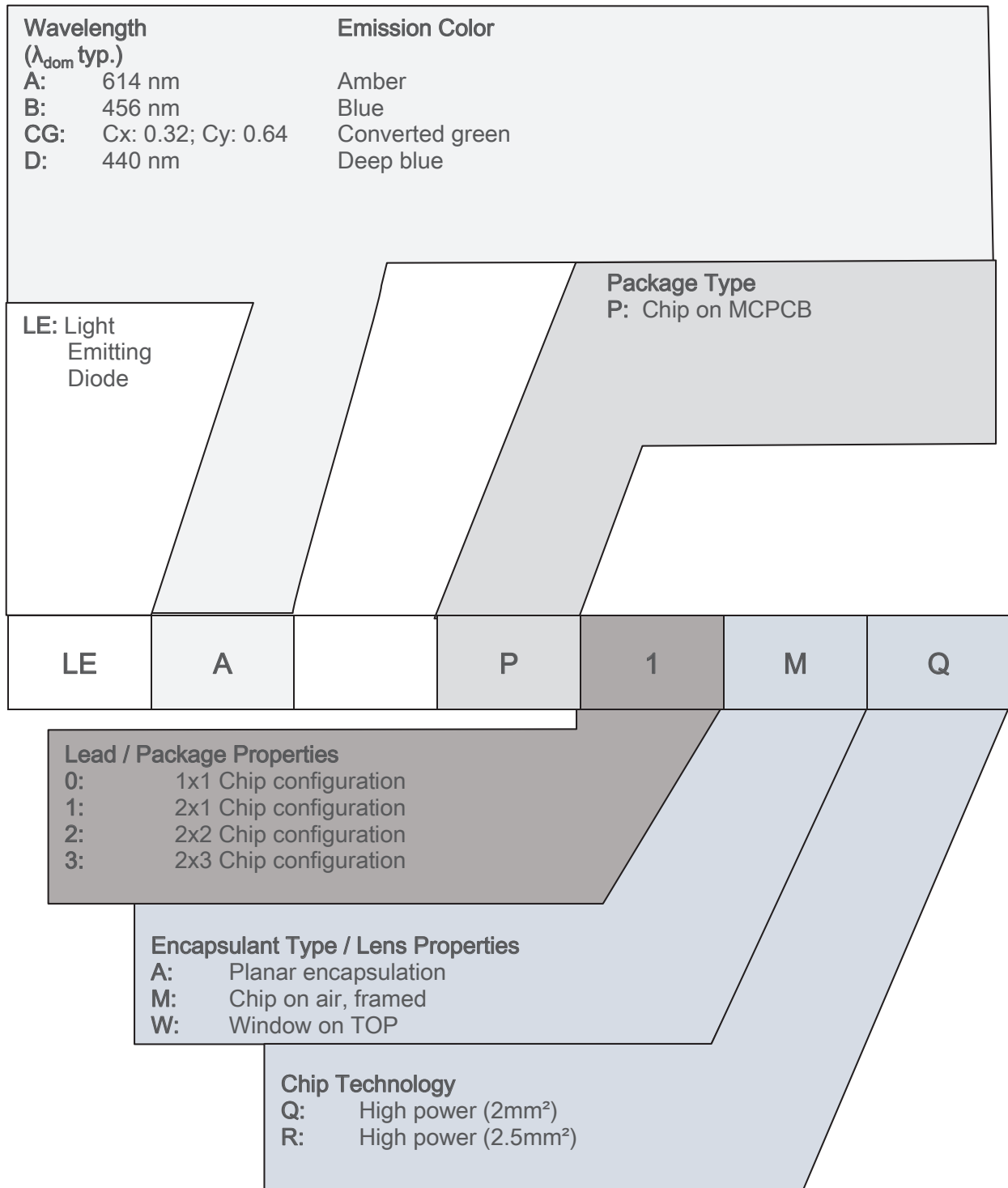

---

## Notes

The evaluation of eye safety occurs according to the standard IEC 62471:2006 (photo biological safety of lamps and lamp systems). Within the risk grouping system of this IEC standard, the device specified in this data sheet fall into the class **moderate risk (exposure time 0.25 s)**. Under real circumstances (for exposure time, conditions of the eye pupils, observation distance), it is assumed that no endangerment to the eye exists from these devices. As a matter of principle, however, it should be mentioned that intense light sources have a high secondary exposure potential due to their blinding effect. When looking at bright light sources (e.g. headlights), temporary reduction in visual acuity and afterimages can occur, leading to irritation, annoyance, visual impairment, and even accidents, depending on the situation.

Subcomponents of this device contain, in addition to other substances, metal filled materials including silver. Metal filled materials can be affected by environments that contain traces of aggressive substances. Therefore, we recommend that customers minimize device exposure to aggressive substances during storage, production, and use. Devices that showed visible discoloration when tested using the described tests above did show no performance deviations within failure limits during the stated test duration. Respective failure limits are described in the IEC60810.

For further application related information please visit [www.osram-os.com/appnotes](http://www.osram-os.com/appnotes)

## Disclaimer

### Attention please!

The information describes the type of component and shall not be considered as assured characteristics. Terms of delivery and rights to change design reserved. Due to technical requirements components may contain dangerous substances.

For information on the types in question please contact our Sales Organization.

If printed or downloaded, please find the latest version on our website.

### Packing

Please use the recycling operators known to you. We can also help you – get in touch with your nearest sales office. By agreement we will take packing material back, if it is sorted. You must bear the costs of transport. For packing material that is returned to us unsorted or which we are not obliged to accept, we shall have to invoice you for any costs incurred.

### Product and functional safety devices/applications or medical devices/applications

Our components are not developed, constructed or tested for the application as safety relevant component or for the application in medical devices.

Our products are not qualified at module and system level for such application.

In case buyer – or customer supplied by buyer – considers using our components in product safety devices/ applications or medical devices/applications, buyer and/or customer has to inform our local sales partner immediately and we and buyer and /or customer will analyze and coordinate the customer-specific request between us and buyer and/or customer.

## Glossary

- 1) **Brightness:** Brightness values are measured during a pulse train of 100 ms with a pulse width of 250  $\mu$ s and a frequency of 1 kHz, with an internal reproducibility of  $\pm$  8 % and an expanded uncertainty of  $\pm$  11 % (acc. to GUM with a coverage factor of  $k = 3$ ). The peak brightness is calculated according to the pulse duration and frequency.
- 2) **Reverse Operation:** This product is intended to be operated applying a forward current within the specified range. Applying any continuous reverse bias or forward bias below the voltage range of light emission shall be avoided because it may cause migration which can change the electro-optical characteristics or damage the LED.
- 3) **Wavelength:** The wavelength is measured during a pulse train of 100 ms with a pulse width of 250  $\mu$ s and a frequency of 1 kHz, with an internal reproducibility of  $\pm$  0,5 nm and an expanded uncertainty of  $\pm$  1 nm (acc. to GUM with a coverage factor of  $k=3$ ).
- 4) **Typical Values:** Due to the special conditions of the manufacturing processes of semiconductor devices, the typical data or calculated correlations of technical parameters can only reflect statistical figures. These do not necessarily correspond to the actual parameters of each single product, which could differ from the typical data and calculated correlations or the typical characteristic line. If requested, e.g. because of technical improvements, these typ. data will be changed without any further notice.
- 5) **Forward Voltage:** The forward voltage is measured during a pulse of typical 250  $\mu$ s, with an internal reproducibility of  $\pm$  0,05 V and an expanded uncertainty of  $\pm$  0,1 V (acc. to GUM with a coverage factor of  $k=3$ ).
- 6) **Characteristic curve:** In the range where the line of the graph is broken, you must expect higher differences between single devices within one packing unit.
- 7) **Tolerance of Measure:** Unless otherwise noted in drawing, tolerances are specified with  $\pm$ 0.1 and dimensions are specified in mm.
- 8) **Tape and Reel:** All dimensions and tolerances are specified acc. IEC 60286-3 and specified in mm.

---

## Revision History

| Version | Date       | Change  |
|---------|------------|---|
| 1.0     | 2020-05-26 | Initial Version   |
| 1.0     | 2020-05-29 | Initial Version   |
| 1.1     | 2020-07-21 | Characteristics   |
| 1.2     | 2021-03-19 | Characteristics<br>Ordering Information<br>Brightness Groups<br>Electro - Optical Characteristics (Diagrams)<br>Tape and Reel<br>Reel Dimensions<br>Maximum Ratings |
| 1.3     | 2022-08-01 | Dimensional Drawing<br>Taping<br>New Layout<br>Applications   |

---



EU RoHS and China RoHS compliant product

此产品符合欧盟 RoHS 指令的要求；  
按照中国的相关法规和标准，  
不含有毒有害物质或元素。

**Published by ams-OSRAM AG**

Tobelbader Strasse 30, 8141 Premstaetten, Austria

Phone +43 3136 500-0

[ams-osram.com](http://ams-osram.com)

© All rights reserved

**am** 

**OSRAM**

## X-ON Electronics

Largest Supplier of Electrical and Electronic Components

*Click to view similar products for [High Power LEDs - Single Colour](#) category:*

*Click to view products by [Osram](#) manufacturer:*

Other Similar products are found below :

[AA2810ASYSK](#) [L1CU-VLT1000000000](#) [GB CS8PM1.13-HYHZ-35-0-350-R18](#) [LR B6SP-T1U2-1-A3D3+DAEA-46-G3R3](#) [GH](#)  
[CSSRM4.24-V7V9-1-1-700-R33](#) [PBLA-15LTE](#) [020010030060020](#) [AA2810AVBS/D](#) [KT CSLNM1.13-MXMZ-34-0](#) [ELUC3535NUB-](#)  
[P7085Q05075020-S21Q](#) [GY CSHPM1.23-KPKR-36-0-350-R18](#) [LZ4-V4UVH0-0000](#) [KB CULPM1.14-BPBQ-W2](#) [KB CULPM1.14-AUBQ-](#)  
[W3](#) [XEGAHR-H2-0000-000-000000H8001](#) [XPEBRY-L1-0000-00S02](#) [XQEAPA-00-0000-000000701](#) [XQEBLU-00-0000-000000Z02](#)  
[SPHWH2L3D30ED4V0H3](#) [XQEBLU-00-0000-000000202](#) [L1SP-DRD0002000000](#) [L1SP-LME0002000000](#) [LHUV-0405-A065](#) [LTPL-](#)  
[C034UVH410](#) [XPGDRY-L1-0000-00601-SB01](#) [XQEGRN-H0-0000-000000901](#) [XPEEPR-L1-0000-00B01](#) [XPGDRY-L1-0000-00501](#)  
[XPGDRY-L1-0000-00401](#) [XQEEPR-00-0000-000000901](#) [XQEEPR-00-0000-000000A01](#) [15335340AA350](#) [XPCRDO-L1-R250-00701](#)  
[XPEBGR-L1-0000-00D03](#) [XPEGRN-L1-0000-00F02](#) [LR H9PP-HZJZ-1-1](#) [15335339AA350](#) [XQERDO-02-0000-000000701](#) [XPEBGR-L1-](#)  
[0000-00E02](#) [15335338AA350](#) [XPEROY-L1-R250-00903](#) [XPEBRY-L1-R250-00R01](#) [XPEEPR-L1-0000-00C01](#) [MLESBL-A1-0000-000U01](#)  
[XPEBPA-L1-R250-00B01](#) [XPERED-L1-R250-00802](#) [XQEBLU-02-0000-000000305](#) [XTEARY-00-0000-000000K03](#) [XTEARY-02-0000-](#)  
[000000L03](#) [XPEBBL-L1-R250-00302](#)