

# OSRAM LZ4-01MWCA

## Datasheet

Published by **ams-OSRAM AG**

Tobelbader Strasse 30, 8141 Premstaetten, Austria

Phone +43 3136 500-0

[ams-osram.com](http://ams-osram.com)

© All rights reserved



## LED ENGINE LuxiGen®

# LZ4-01MWCA

Industry's most robust high power ceramic package with silicone flat top for high performance over life.

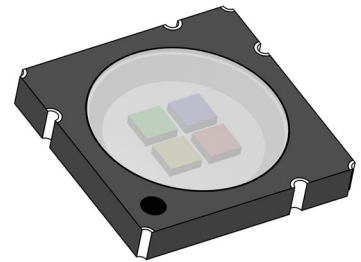

## Applications

- Entertainment
- Outdoor & Industrial Lighting

## Features

- Package: Ceramic package, clear silicone
- Chip technology: Thinfilm / UX:3
- Typ. Radiation: 120°
- Color:  $\lambda_{\text{dom}} = 623 \text{ nm}$  (● red);  $\lambda_{\text{dom}} = 520 \text{ nm}$  (● true green);  $\lambda_{\text{dom}} = 451 \text{ nm}$  (● blue);  $C_x = 0.435$ ,  $C_y = 0.405$  acc. to CIE 1931 (● warm white)
- CRI: 85 (typ.)

## Ordering Information

Type	Brightness <sup>1)</sup>	Ordering Code
LZ4-01MWCA-0000_G2		Q65113A6755
• red	• $\Phi_V = 105 \dots 160 \text{ lm}$ ( $I_F = 1000 \text{ mA}$ )	
• true green	• $\Phi_V = 160 \dots 280 \text{ lm}$ ( $I_F = 1000 \text{ mA}$ )	
• blue	• $\Phi_E = 1.0 \dots 1.5 \text{ W}$ ( $I_F = 1000 \text{ mA}$ )	
• warm white	• $\Phi_V = 140 \dots 225 \text{ lm}$ ( $I_F = 1000 \text{ mA}$ )	

## Maximum Ratings

Parameter	Symbol		Values	Values	Values	Values
			● red	● true green	● blue	● warm white
Operating Temperature	$T_{op}$	min.	-40 °C	-40 °C	-40 °C	-40 °C
		max.	125 °C	125 °C	125 °C	125 °C
Storage Temperature	$T_{stg}$	min.	-40 °C	-40 °C	-40 °C	-40 °C
		max.	125 °C	125 °C	125 °C	125 °C
Junction Temperature <sup>2)</sup>	$T_j$	max.	125 °C	125 °C	125 °C	125 °C
Forward Current <sup>2)</sup>	$I_F$	max.	2500 mA	3000 mA	3000 mA	1500 mA
Forward Current pulsed $t \leq 10 \text{ ms}$ ; $D \leq 0.1$ ; $T_C = 25 \text{ °C}$	$I_{F \text{ pulse}}$	max.	3000 mA	3000 mA	3000 mA	1500 mA
ESD withstand voltage acc. ANSI/ESDA/JEDEC JS-001 (HBM, Class 0)	$V_{ESD}$		ESD sensitive device	ESD sensitive device	ESD sensitive device	ESD sensitive device
Reverse voltage <sup>3)</sup>	$V_R$		Not designed for reverse operation	Not designed for reverse operation	Not designed for reverse operation	Not designed for reverse operation

## Characteristics

$I_F = 1000 \text{ mA}$ ;  $T_C = 25 \text{ °C}$

Parameter	Symbol		Values			
			● red	● true green	● blue	● warm white
Chromaticity Coordinate <sup>4)</sup>	Cx	typ.				0.435
	Cy	typ.				0.405
Dominant Wavelength <sup>5)</sup> $I_F = 1000 \text{ mA}$	$\lambda_{\text{dom}}$	min.	620 nm	519 nm	449 nm	
		typ.	623 nm	520 nm	451 nm	
		max.	628 nm	525 nm	458 nm	
Viewing angle at 50% $I_V$	$2\phi$	typ.	110 °	110 °	110 °	110 °
Forward Voltage <sup>6)7)</sup> $I_F = 1000 \text{ mA}$	$V_F$	min.	1.8 V	2.5 V	2.7 V	2.8 V
		typ.	2.3 V	2.9 V	3.0 V	3.6 V
		max.	2.8 V	3.5 V	3.4 V	3.8 V
Reverse current <sup>3)</sup>	$I_R$		Not designed for reverse operation	Not designed for reverse operation	Not designed for reverse operation	Not designed for reverse operation
Color Rendering Index <sup>8)</sup>	$R_a$	typ.				85
Electrical thermal resistance junction/case Value in the first column relates to full package with all chips operated simultaneously.	$R_{\text{thJC elec.}}$	typ.	1.1 K / W			

## Brightness Groups

- red

Group	Luminous Flux <sup>1)</sup> $I_F = 1000 \text{ mA}$ min. $\Phi_V$	Luminous Flux <sup>1)</sup> $I_F = 1000 \text{ mA}$ max. $\Phi_V$
17R	105 lm	160 lm

## Brightness Groups

- true green

Group	Luminous Flux <sup>1)</sup> $I_F = 1000 \text{ mA}$ min. $\Phi_V$	Luminous Flux <sup>1)</sup> $I_F = 1000 \text{ mA}$ max. $\Phi_V$
23G	160 lm	280 lm

## Brightness Groups

- blue

Group	Total radiant flux <sup>1)</sup> $I_F = 1000 \text{ mA}$ min. $\Phi_E$	Total radiant flux <sup>1)</sup> $I_F = 1000 \text{ mA}$ max. $\Phi_E$
19B	1.0 W	1.5 W

## Brightness Groups

- warm white

Group	Luminous Flux <sup>1)</sup> $I_F = 1000 \text{ mA}$ min. $\Phi_V$	Luminous Flux <sup>1)</sup> $I_F = 1000 \text{ mA}$ max. $\Phi_V$
11W	140 lm	225 lm

## Wavelength Groups

- red

Group	Dominant Wavelength <sup>5)</sup> $I_F = 1000 \text{ mA}$ min. $\lambda_{\text{dom}}$	Dominant Wavelength <sup>5)</sup> $I_F = 1000 \text{ mA}$ max. $\lambda_{\text{dom}}$
R03	620 nm	628 nm

## Wavelength Groups

- true green

Group	Dominant Wavelength <sup>5)</sup> $I_F = 1000 \text{ mA}$ min. $\lambda_{\text{dom}}$	Dominant Wavelength <sup>5)</sup> $I_F = 1000 \text{ mA}$ max. $\lambda_{\text{dom}}$
G04	519 nm	525 nm

## Wavelength Groups

- blue

Group	Dominant Wavelength <sup>5)</sup> $I_F = 1000 \text{ mA}$ min. $\lambda_{\text{dom}}$	Dominant Wavelength <sup>5)</sup> $I_F = 1000 \text{ mA}$ max. $\lambda_{\text{dom}}$
B05	449 nm	453 nm
B08	453 nm	458 nm

## Chromaticity Coordinate Groups

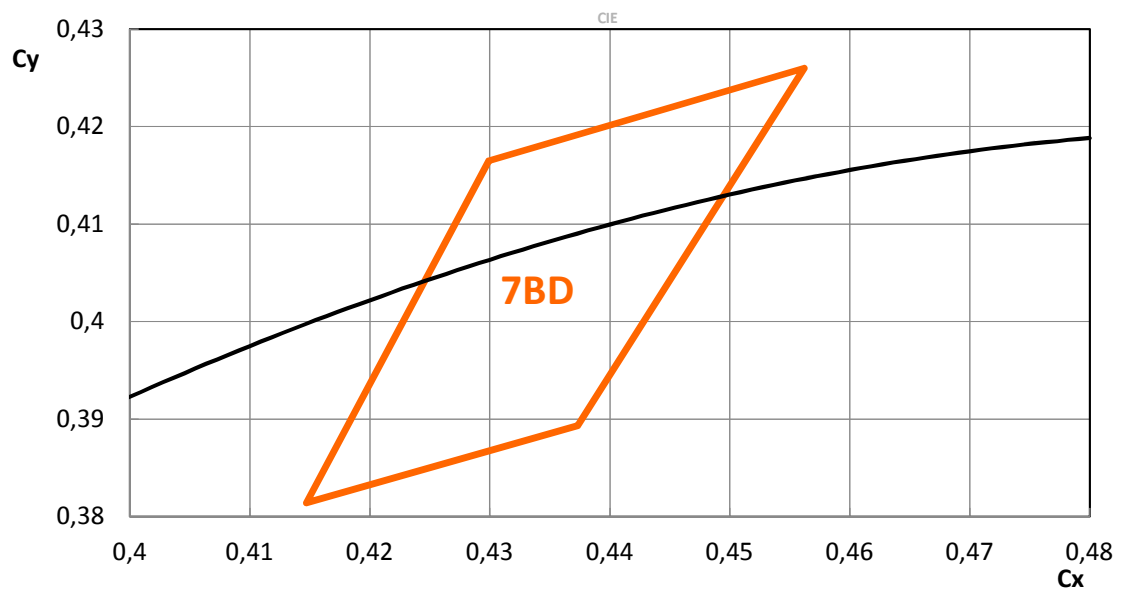

## Chromaticity Coordinate Groups

- warm white

Group	Cx	Cy
7BD	0.4147	0.3814
	0.4299	0.4165
	0.4562	0.4260
	0.4373	0.3893



### Relative Spectral Emission <sup>7)</sup>

$I_{rel} = f(\lambda); I_F = 1000 \text{ mA}; T_C = 25 \text{ }^\circ\text{C}$

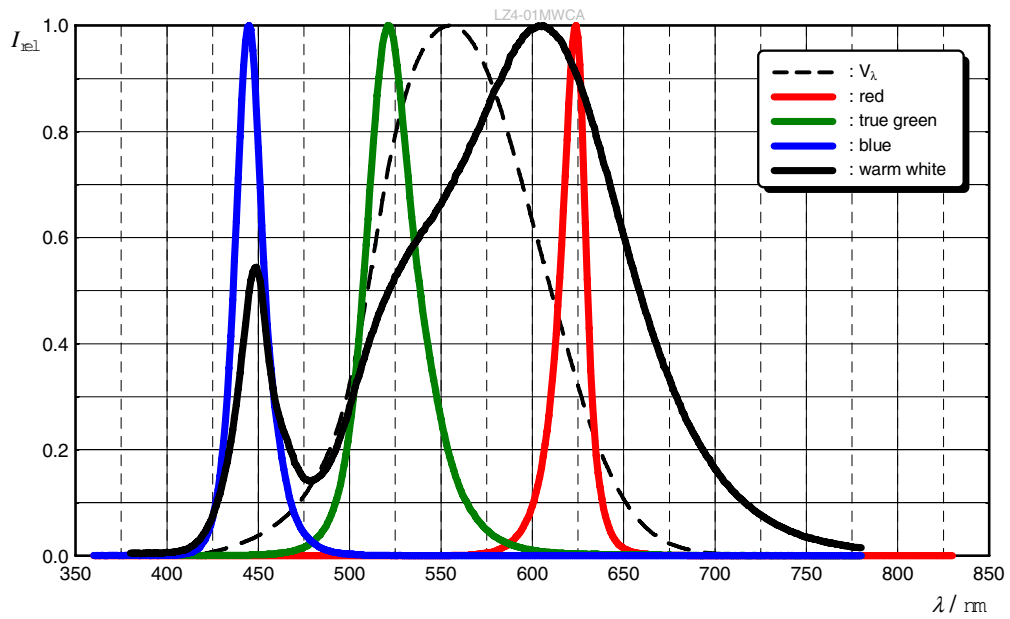

### Radiation Characteristics <sup>7)</sup>

$I_{rel} = f(\phi); T_C = 25 \text{ }^\circ\text{C}$

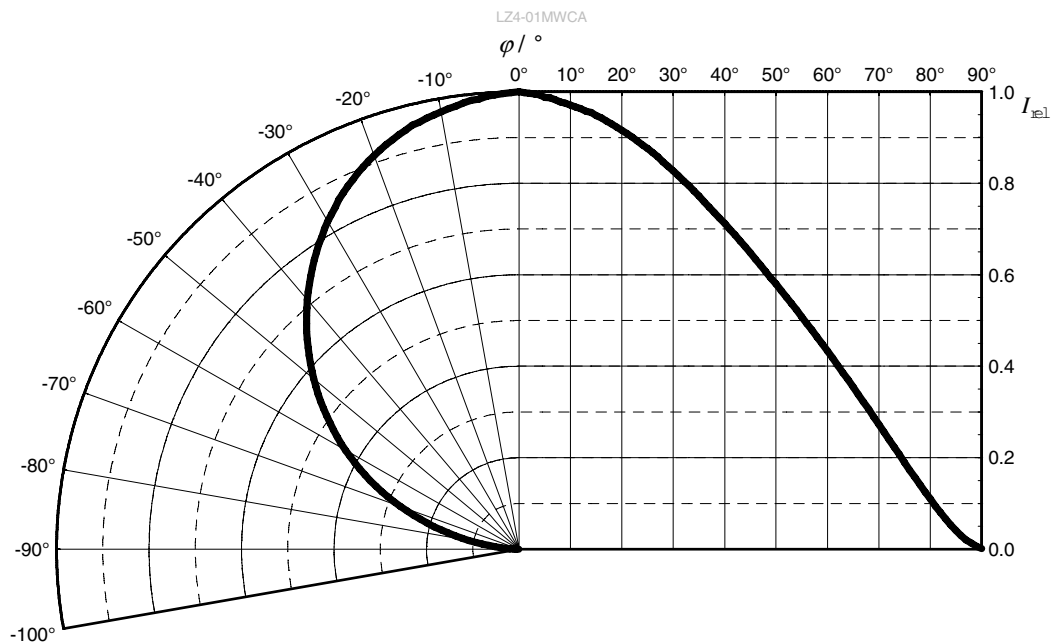

**Forward current** <sup>7)</sup>

$I_F = f(V_F); T_C = 25\text{ °C}$

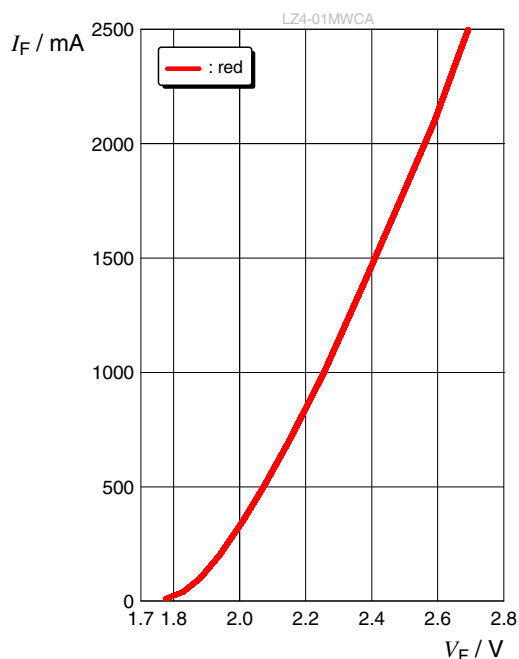

**Forward current** <sup>7)</sup>

$I_F = f(V_F); T_C = 25\text{ °C}$

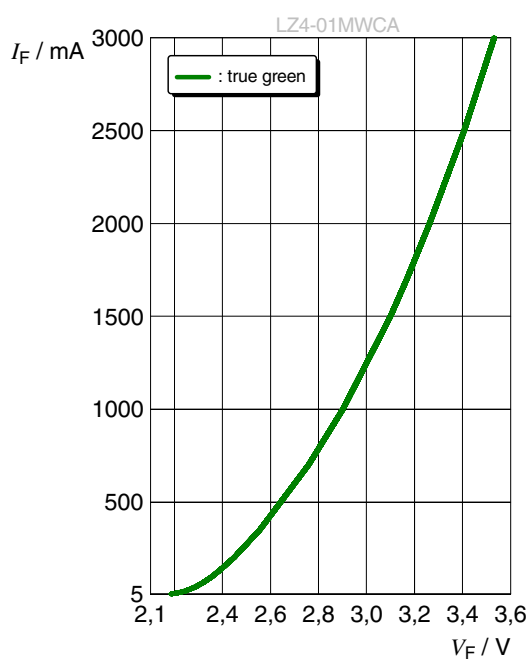

**Forward current** <sup>7)</sup>

$I_F = f(V_F); T_C = 25\text{ °C}$

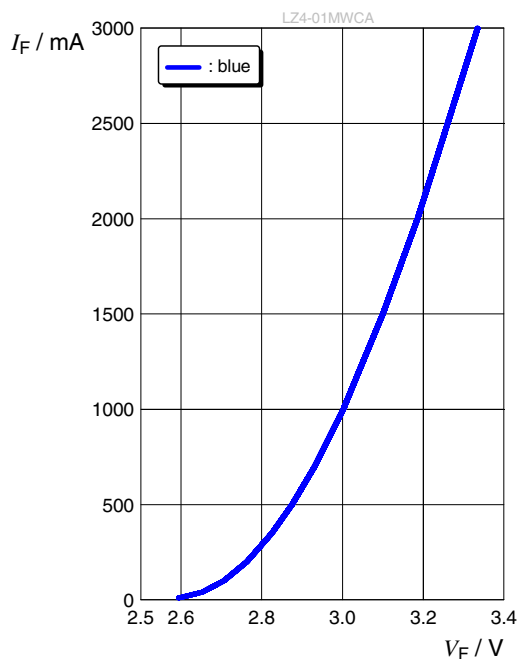

**Forward current** <sup>7)</sup>

$I_F = f(V_F); T_C = 25\text{ °C}$

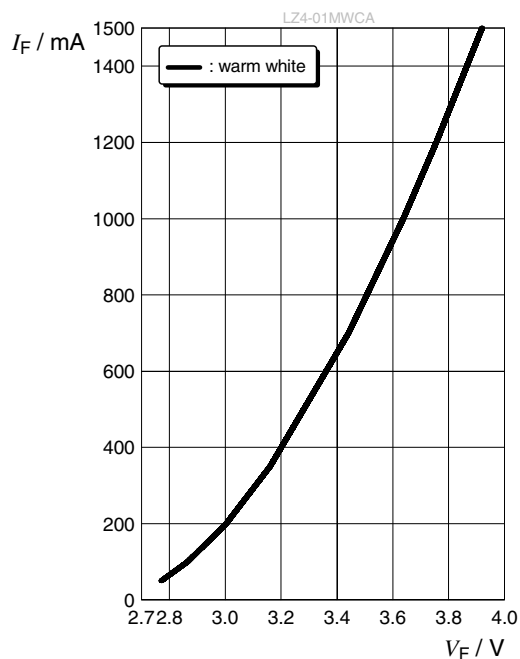

### Relative Luminous Flux <sup>7), 9)</sup>

$$\Phi_V / \Phi_V(1000 \text{ mA}) = f(I_F); T_C = 25 \text{ }^\circ\text{C}$$

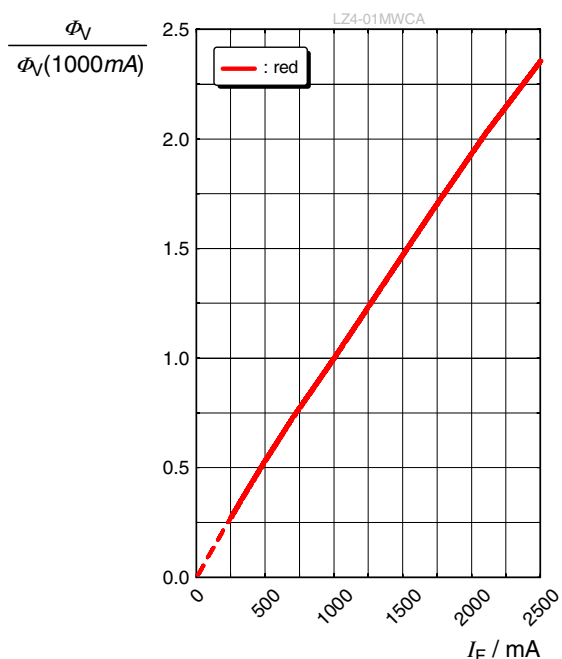

### Relative Luminous Flux <sup>7), 9)</sup>

$$\Phi_V / \Phi_V(1000 \text{ mA}) = f(I_F); T_C = 25 \text{ }^\circ\text{C}$$

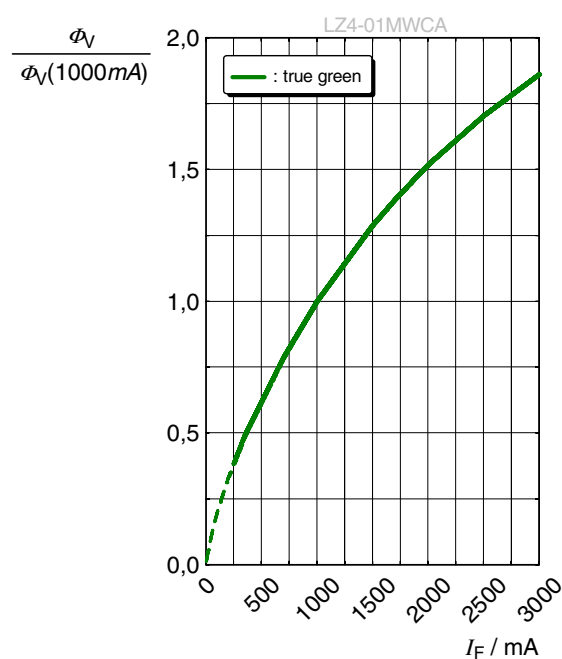

### Relative Radiant Power <sup>7), 9)</sup>

$$\Phi_E / \Phi_E(1000 \text{ mA}) = f(I_F); T_C = 25 \text{ }^\circ\text{C}$$

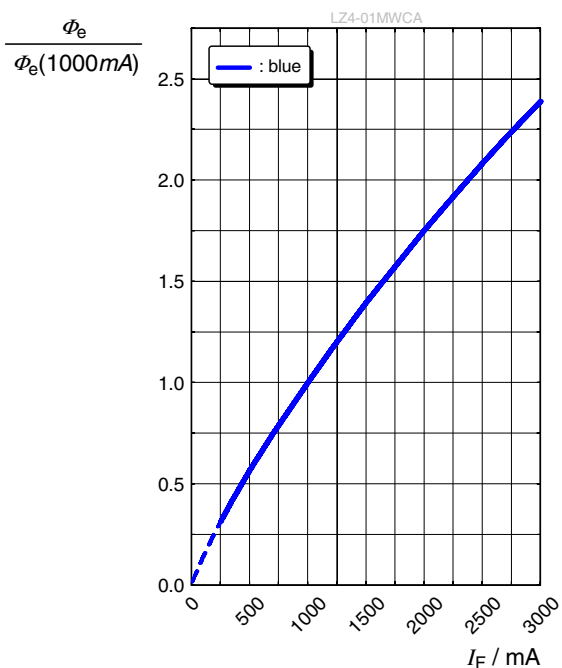

### Relative Luminous Flux <sup>7), 9)</sup>

$$\Phi_V / \Phi_V(1000 \text{ mA}) = f(I_F); T_C = 25 \text{ }^\circ\text{C}$$

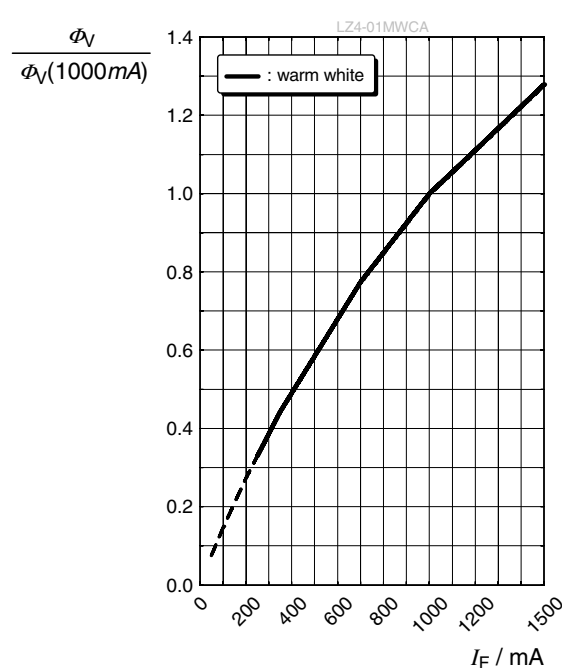

### Dominant Wavelength <sup>7)</sup>

$$\Delta\lambda_{\text{dom}} = f(I_F); T_C = 25\text{ }^\circ\text{C}$$

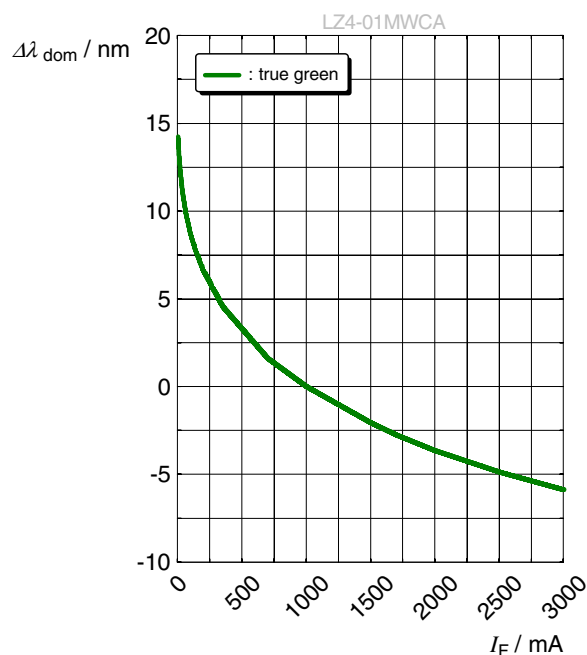

### Dominant Wavelength <sup>7)</sup>

$$\Delta\lambda_{\text{dom}} = f(I_F); T_C = 25\text{ }^\circ\text{C}$$

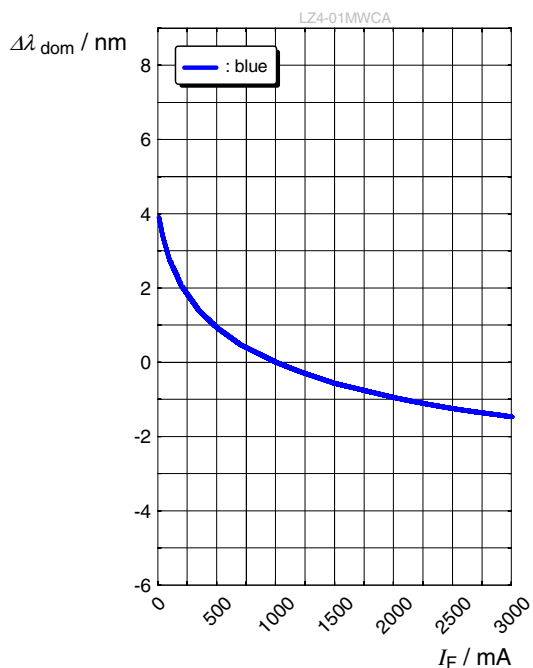

### Chromaticity Coordinate Shift <sup>7)</sup>

$$\Delta C_x, \Delta C_y = f(I_F); T_C = 25\text{ }^\circ\text{C}$$

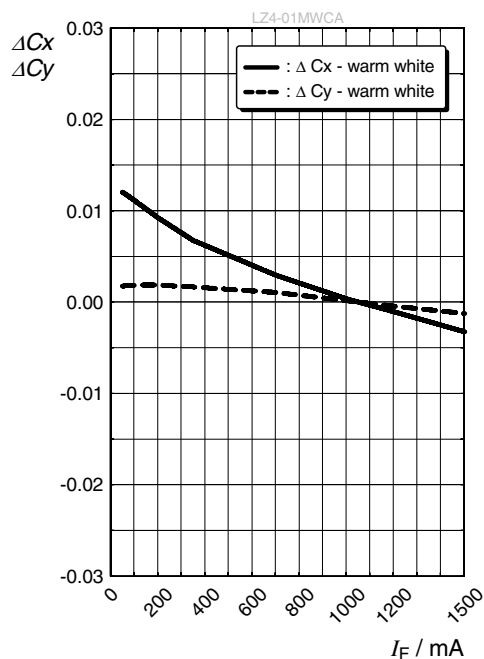

### Forward Voltage <sup>7)</sup>

$$\Delta V_F = V_F - V_F(25\text{ °C}) = f(T_j); I_F = 1000\text{ mA}$$

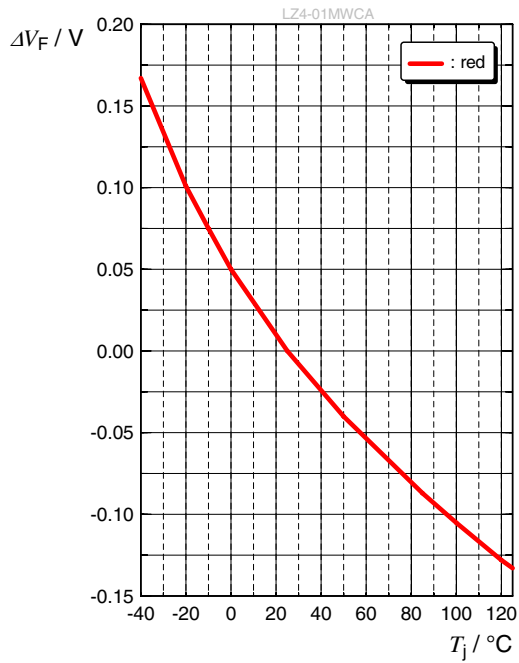

### Forward Voltage <sup>7)</sup>

$$\Delta V_F = V_F - V_F(25\text{ °C}) = f(T_j); I_F = 1000\text{ mA}$$

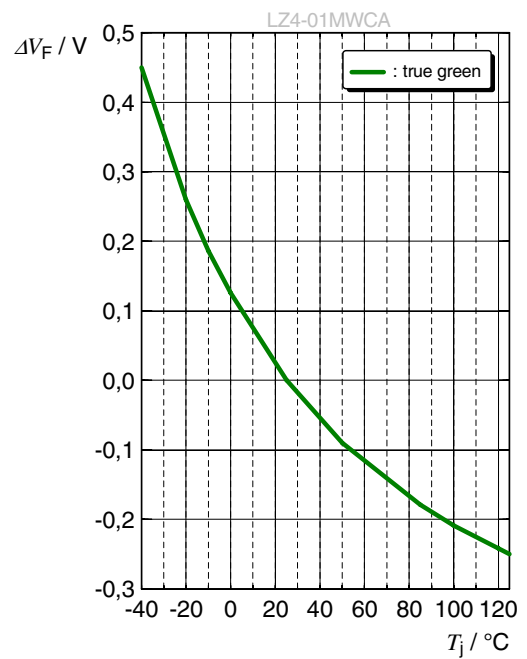

### Forward Voltage <sup>7)</sup>

$$\Delta V_F = V_F - V_F(25\text{ °C}) = f(T_j); I_F = 1000\text{ mA}$$

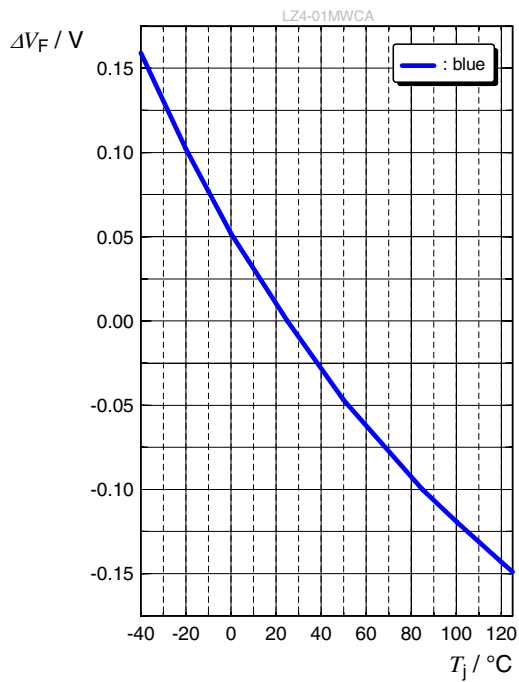

### Forward Voltage <sup>7)</sup>

$$\Delta V_F = V_F - V_F(25\text{ °C}) = f(T_j); I_F = 1000\text{ mA}$$

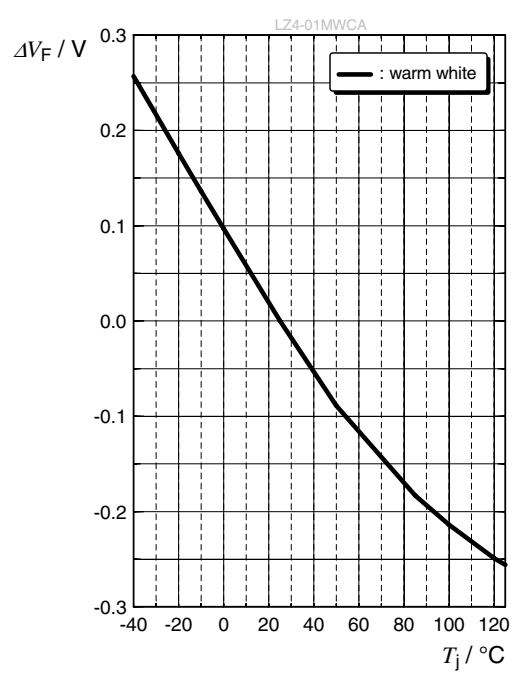

### Relative Luminous Flux <sup>7)</sup>

$$\Phi_V / \Phi_V(25^\circ\text{C}) = f(T_j); I_F = 1000 \text{ mA}$$

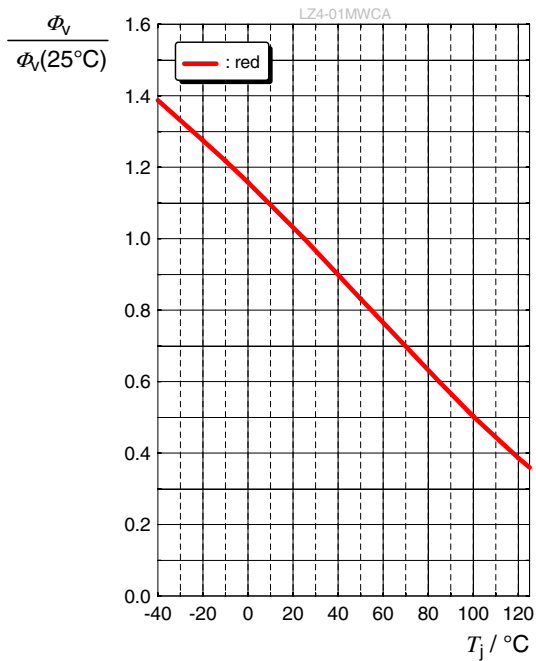

### Relative Luminous Flux <sup>7)</sup>

$$\Phi_V / \Phi_V(25^\circ\text{C}) = f(T_j); I_F = 1000 \text{ mA}$$

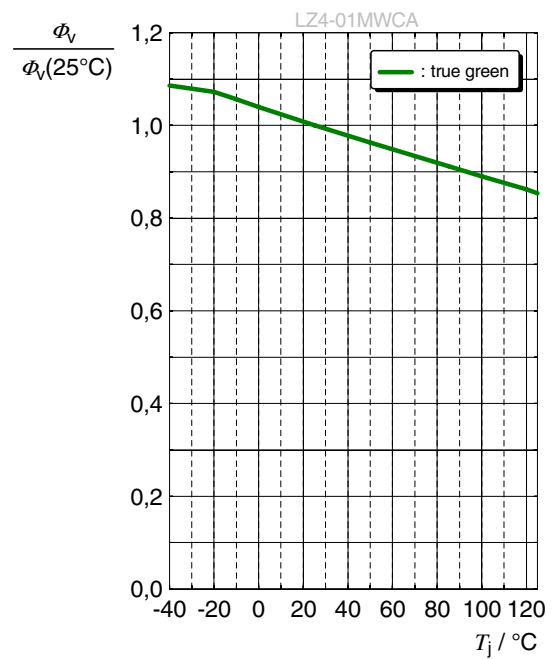

### Relative Radiant Power <sup>7)</sup>

$$\Phi_E / \Phi_E(25^\circ\text{C}) = f(T_j); I_F = 1000 \text{ mA}$$

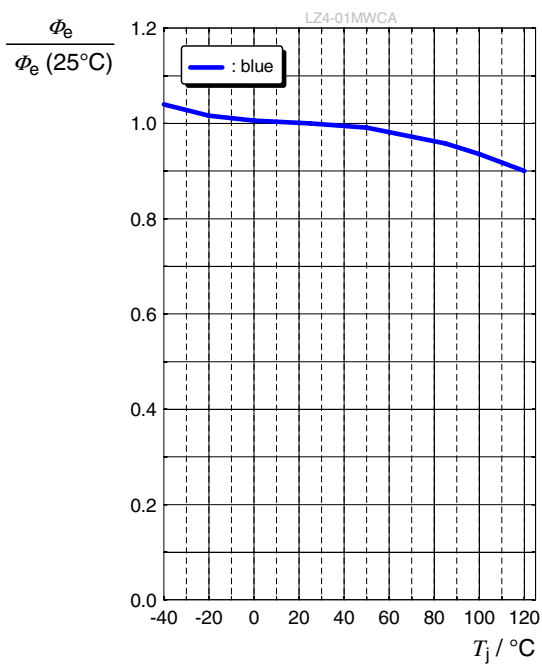

### Relative Luminous Flux <sup>7)</sup>

$$\Phi_V / \Phi_V(25^\circ\text{C}) = f(T_j); I_F = 1000 \text{ mA}$$

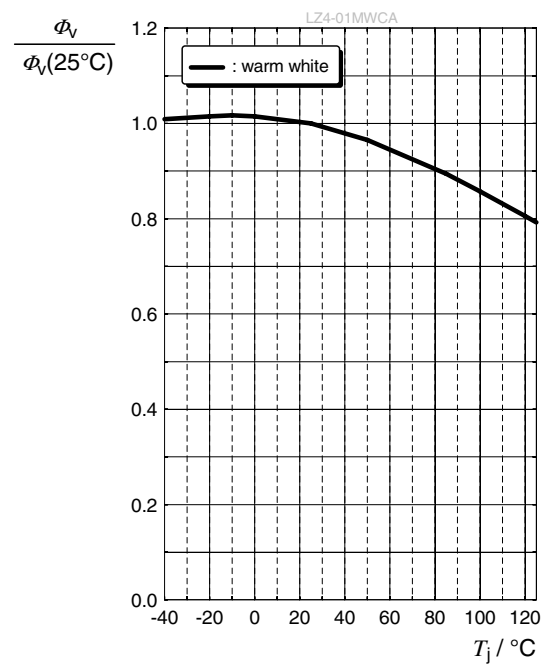

### Dominant Wavelength <sup>7)</sup>

$$\Delta\lambda_{\text{dom}} = \lambda_{\text{dom}} - \lambda_{\text{dom}}(25\text{ °C}) = f(T_j); I_F = 1000\text{ mA}$$

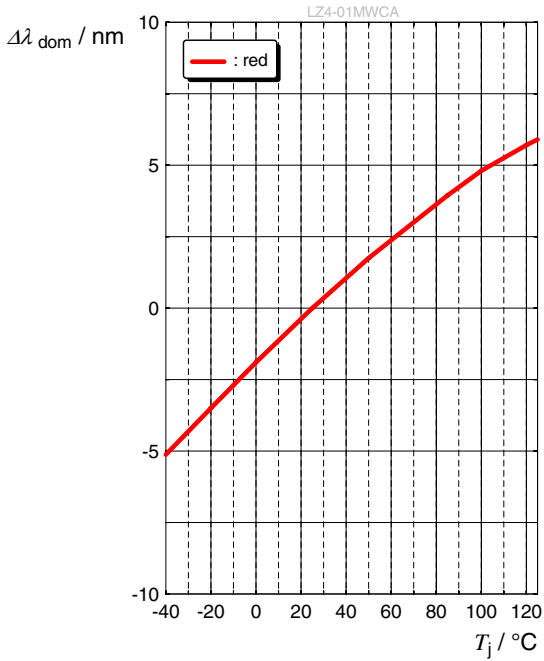

### Dominant Wavelength <sup>7)</sup>

$$\Delta\lambda_{\text{dom}} = \lambda_{\text{dom}} - \lambda_{\text{dom}}(25\text{ °C}) = f(T_j); I_F = 1000\text{ mA}$$

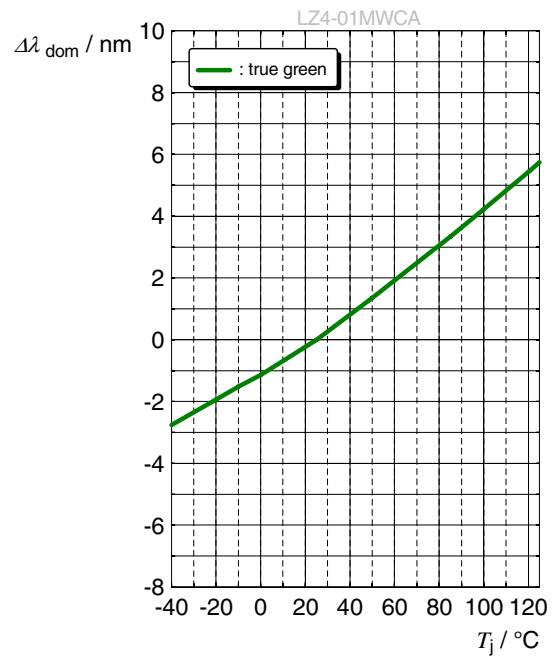

### Dominant Wavelength <sup>7)</sup>

$$\Delta\lambda_{\text{dom}} = \lambda_{\text{dom}} - \lambda_{\text{dom}}(25\text{ °C}) = f(T_j); I_F = 1000\text{ mA}$$

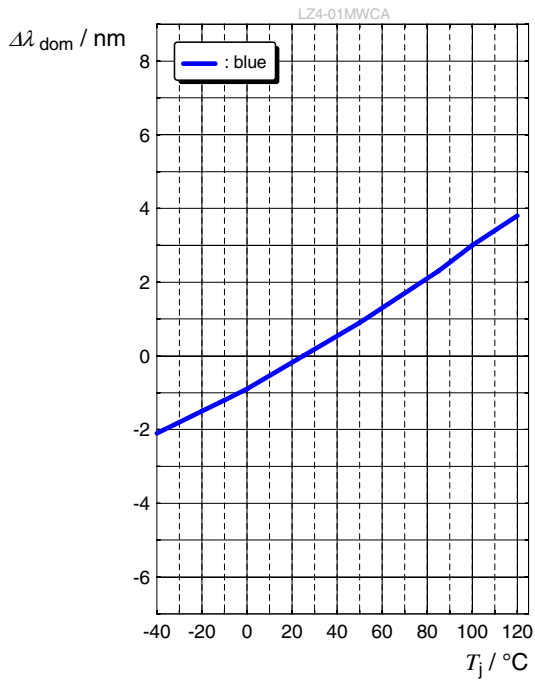

### Chromaticity Coordinate Shift <sup>7)</sup>

$$\Delta C_x, \Delta C_y = f(T_j); I_F = 1000\text{ mA}$$

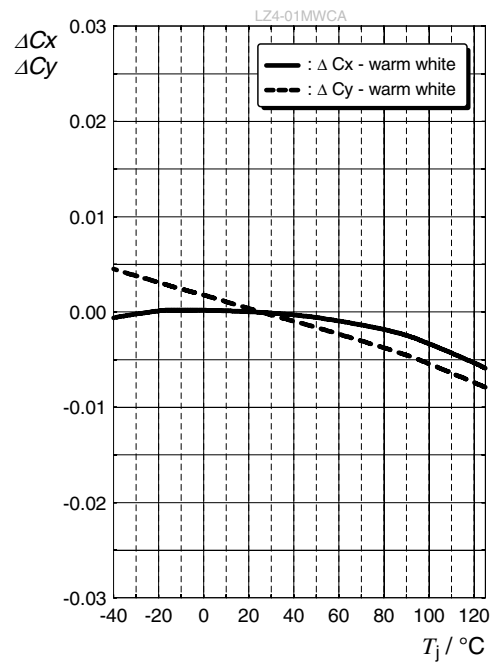

### Max. Permissible Forward Current <sup>10)</sup>

$$I_F = f(T)$$

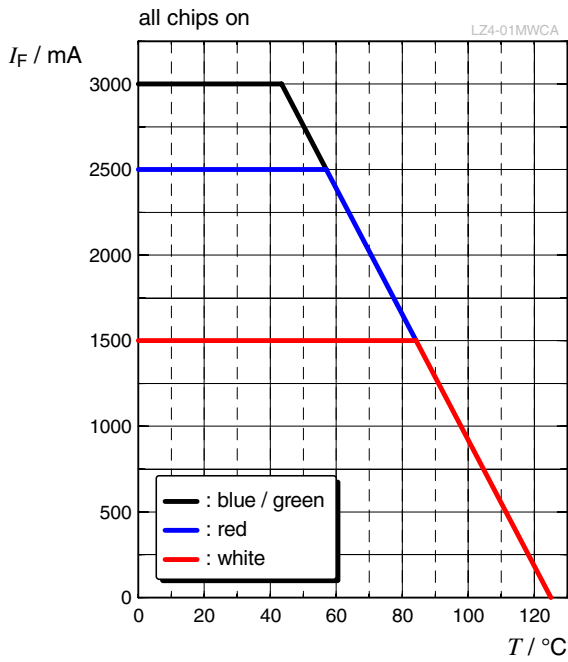



Dimensional Drawing 11)

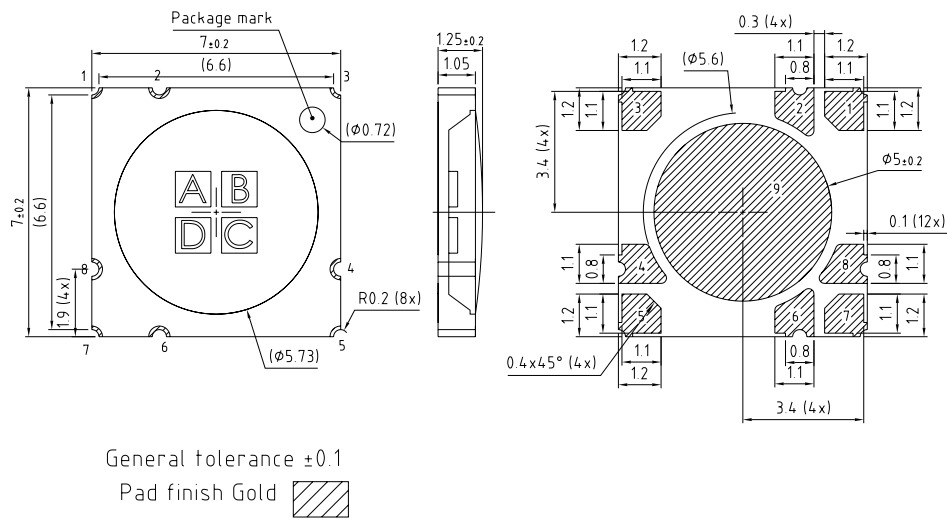

C67062-A0364-A2..-03

Further Information:

Approximate Weight: 163.0 mg

### Electrical Internal Circuit

Pin Out		
Pad	Die	Function
1	A	Anode
2	A	Cathode
3	B	Cathode
4	B	Anode
5	C	Cathode
6	C	Anode
7	D	Cathode
8	D	Anode
9	n/a	Thermal

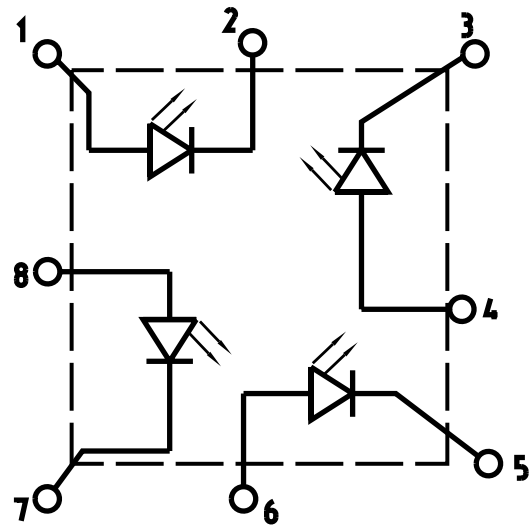

Pin	Description
1, 2	Die A - red
3, 4	Die B - warm white
5, 6	Die C - true green
7, 8	Die D - blue

Recommended Solder Pad <sup>1)</sup>

Pedestal MCPCB Design

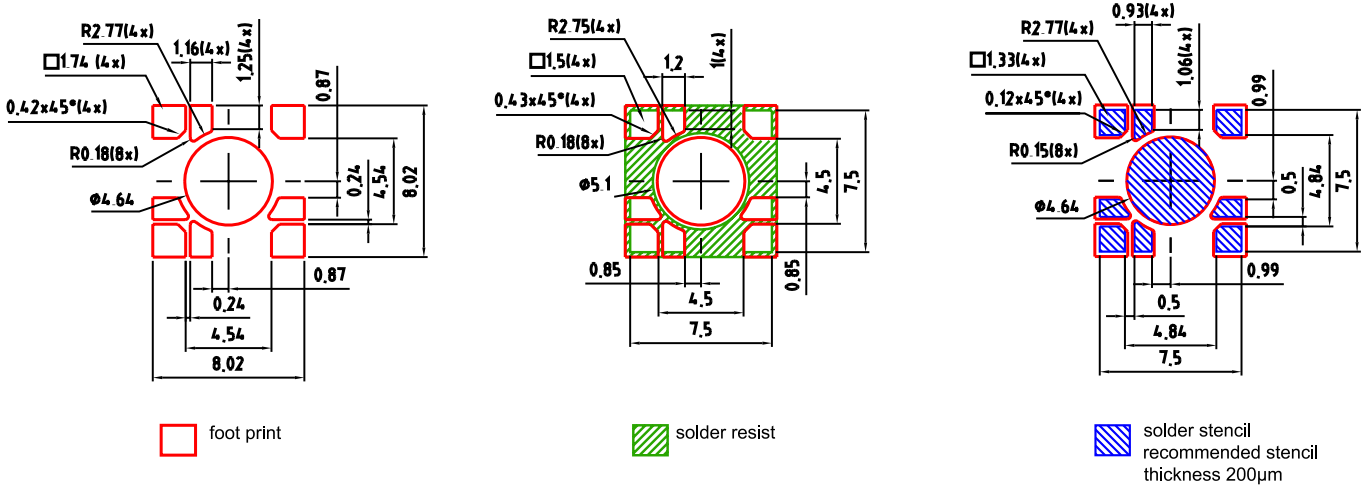

Component Location on Pad

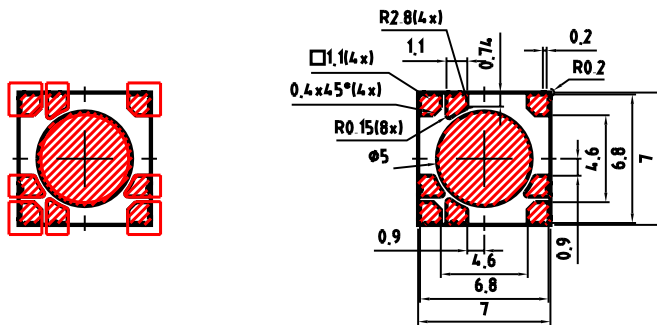

E062.3010.291-01

1. For superior solder joint connectivity results we recommend soldering under standard nitrogen atmosphere.
2. Package not suitable for ultra sonic cleaning.
3. Pedestal MCPCB allows the emitter thermal slug to be soldered directly to the metal core of the MCPCB. Such MCPCB eliminate the high thermal resistance dielectric layer that standard MCPCB technologies use in between the emitter thermal slug and the metal core of the MCPCB, thus lowering the overall system thermal resistance.
4. X-ray sample monitoring for solder voids underneath the emitter thermal slug is recommended. The total area covered by solder voids should be less than 20% of the total emitter thermal slug area. Excessive solder voids will increase the emitter to MCPCB thermal resistance and may lead to higher failure rates due to thermal over stress.

## Reflow Soldering Profile

Product complies to MSL Level 1 acc. to JEDEC J-STD-020E

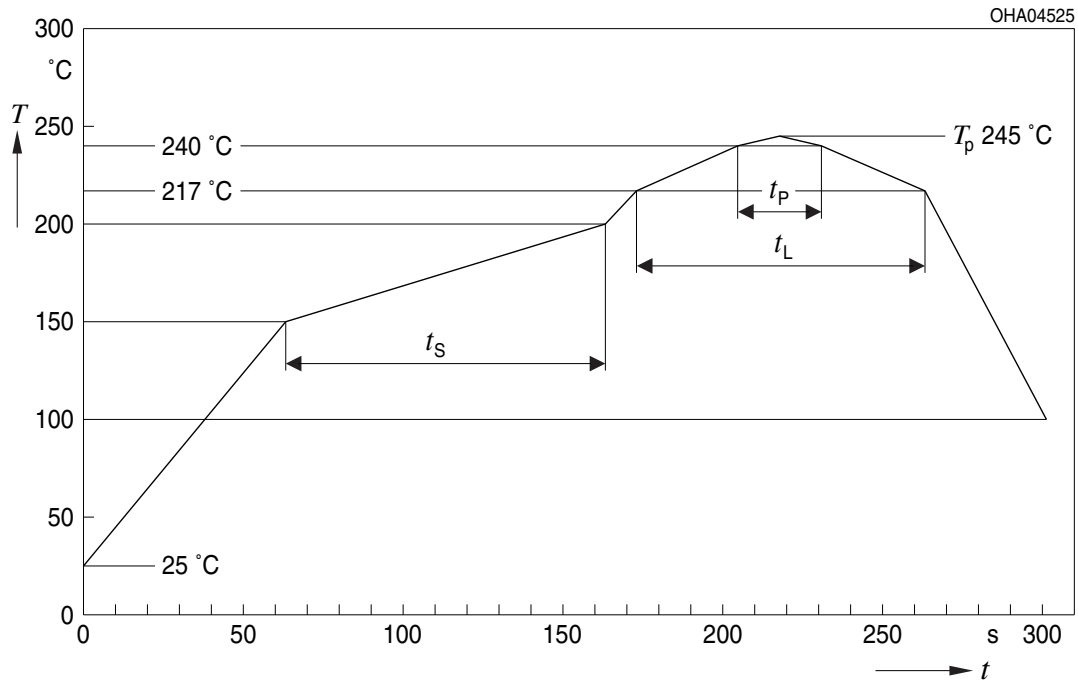

Profile Feature	Symbol	Pb-Free (SnAgCu) Assembly			Unit
		Minimum	Recommendation	Maximum	
Ramp-up rate to preheat <sup>*)</sup> 25 °C to 150 °C			2	3	K/s
Time $t_s$ $T_{Smin}$ to $T_{Smax}$	$t_s$	60	100	120	s
Ramp-up rate to peak <sup>*)</sup> $T_{Smax}$ to $T_p$			2	3	K/s
Liquidus temperature	$T_L$		217		°C
Time above liquidus temperature	$t_L$		80	100	s
Peak temperature	$T_p$		245	260	°C
Time within 5 °C of the specified peak temperature $T_p - 5$ K	$t_p$	10	20	30	s
Ramp-down rate* $T_p$ to 100 °C			3	6	K/s
Time 25 °C to $T_p$				480	s

All temperatures refer to the center of the package, measured on the top of the component

\* slope calculation  $DT/Dt$ :  $Dt$  max. 5 s; fulfillment for the whole T-range

Taping <sup>11)</sup>

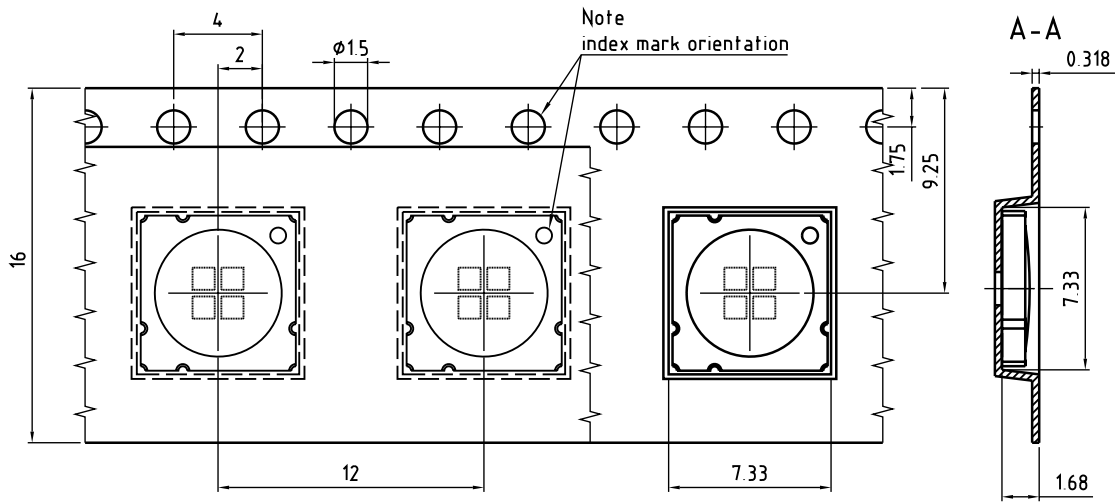

C67062-A0364-B1-01

Tape and Reel <sup>12)</sup>

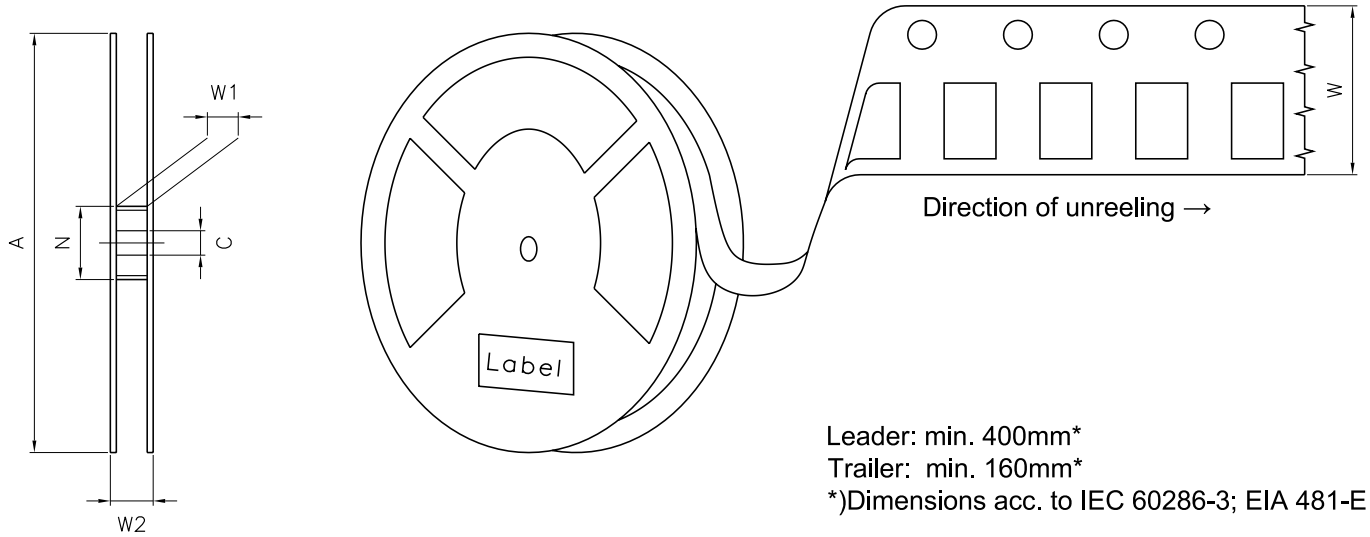

Reel Dimensions

A	W	N <sub>min</sub>	W <sub>1</sub>	W <sub>2max</sub>	Pieces per PU
180 mm	16 + 0.3 / - 0.1 mm	60/100 mm	16.4 + 2 mm	22.4 mm	500

**Barcode-Product-Label (BPL)**

**OSRAM**  
Opto Semiconductors  
Our Brand   
**LED ENGINE**

LXX-XXXXX BIN1: XXX-X-X-XXX  
XxxXxx BIN2: XXX-X-X-XXX  
RoHS Compliant BIN3: XX-X-X-XXX  
BIN4: XXX-XXX-X-XXX  
BIN5: X-XX-X-XXX  
BIN6: X-XX-X-XXX

(6P) Batch No: 1234567890 ML TEMP ST  
(1T) Lot No: 1234567890 X XXX° X 

(X) Prod No: 12345678  
(9D) D/C : 1234 Pack: RXX  
(Q) Qty: 9999 B\_X123\_12345.1234  
CoO: XX 001



---

## Notes

The evaluation of eye safety occurs according to the standard IEC 62471:2006 (photo biological safety of lamps and lamp systems). Within the risk grouping system of this IEC standard, the device specified in this data sheet fall into the class **moderate risk (exposure time 0.25 s)**. Under real circumstances (for exposure time, conditions of the eye pupils, observation distance), it is assumed that no endangerment to the eye exists from these devices. As a matter of principle, however, it should be mentioned that intense light sources have a high secondary exposure potential due to their blinding effect. When looking at bright light sources (e.g. headlights), temporary reduction in visual acuity and afterimages can occur, leading to irritation, annoyance, visual impairment, and even accidents, depending on the situation.

Subcomponents of this device contain, in addition to other substances, metal filled materials including silver. Metal filled materials can be affected by environments that contain traces of aggressive substances. Therefore, we recommend that customers minimize device exposure to aggressive substances during storage, production, and use. Devices that showed visible discoloration when tested using the described tests above did show no performance deviations within failure limits during the stated test duration. Respective failure limits are described in the IEC60810.

Tapes and reels are shipped in airtight bags in order to reduce the onset of silver tarnish. We recommend bags only be opened when ready to use emitters. Partially used reels or trays should be stored in airtight bags or in storage purged with nitrogen.

Based on very short life cycle times in chip technology this component is subject to frequent adaption to the latest chip technology.

Changes to the content of this datasheet may occur without further notification. JEDEC 46C constitutes the guideline of the change management for the device specified in this document.

For further application related information please visit <https://ams-osram.com/support/application-notes>



## Disclaimer

### Attention please!

The information describes the type of component and shall not be considered as assured characteristics. Terms of delivery and rights to change design reserved. Due to technical requirements components may contain dangerous substances.

For information on the types in question please contact our Sales Organization.

If printed or downloaded, please find the latest version on our website.

### Packing

Please use the recycling operators known to you. We can also help you – get in touch with your nearest sales office. By agreement we will take packing material back, if it is sorted. You must bear the costs of transport. For packing material that is returned to us unsorted or which we are not obliged to accept, we shall have to invoice you for any costs incurred.

### Product and functional safety devices/applications or medical devices/applications

Our components are not developed, constructed or tested for the application as safety relevant component or for the application in medical devices.

Our products are not qualified at module and system level for such application.

In case buyer – or customer supplied by buyer – considers using our components in product safety devices/ applications or medical devices/applications, buyer and/or customer has to inform our local sales partner immediately and we and buyer and /or customer will analyze and coordinate the customer-specific request between us and buyer and/or customer.

---

## Glossary

- 1) **Brightness:** Brightness groups are tested at a current pulse duration of 10 ms and a tolerance of  $\pm 10\%$ .
- 2) **Operating Conditions:** Operating conditions according DC-derating (Max. Permissible Forward Current)
- 3) **Reverse Operation:** Not designed for reverse operation. Continuous reverse operation can cause migration and damage of the device.
- 4) **Chromaticity coordinate groups:** Chromaticity coordinate groups are tested at a current pulse duration of 10 ms and a tolerance of  $\pm 0.01$ .
- 5) **Wavelength:** Wavelengths are tested at a current pulse duration of 10 ms and a tolerance of  $\pm 1$  nm.
- 6) **Forward Voltage:** Forward voltages are tested at a current pulse duration of 10 ms and a tolerance of  $\pm 0.1$  V.
- 7) **Typical Values:** Due to the special conditions of the manufacturing processes of semiconductor devices, the typical data or calculated correlations of technical parameters can only reflect statistical figures. These do not necessarily correspond to the actual parameters of each single product, which could differ from the typical data and calculated correlations or the typical characteristic line. If requested, e.g. because of technical improvements, these typ. data will be changed without any further notice.
- 8) **Color reproduction index:** Color reproduction index values (CRI-RA) are measured during a current pulse of typically 25 ms, with an internal reproducibility of  $\pm 2$  and an expanded uncertainty of  $\pm 3$  (acc. to GUM with a coverage factor of  $k = 3$ ).
- 9) **Characteristic curve:** In the range where the line of the graph is broken, you must expect higher differences between single devices within one packing unit.
- 10) **Thermal Resistance:**  $R_{th\ max}$  is based on statistic values ( $6\sigma$ ) used for Derating.
- 11) **Tolerance of Measure:** Unless otherwise noted in drawing, tolerances are specified with  $\pm 0.1$  and dimensions are specified in mm.
- 12) **Tape and Reel:** All dimensions and tolerances are specified acc. IEC 60286-3 and specified in mm.

---

## Revision History

Version	Date	Change
1.1	2022-02-01	New Layout
1.2	2022-02-04	Recommended Solder Pad
1.3	2023-07-14	New Layout Applications Ordering Information Characteristics Brightness Groups Electro - Optical Characteristics (Diagrams)
1.4	2023-12-07	Dimensional Drawing



EU RoHS and China RoHS compliant product

此产品符合欧盟 RoHS 指令的要求；  
按照中国的相关法规和标准，  
不含有毒有害物质或元素。

**Published by ams-OSRAM AG**

Tobelbader Strasse 30, 8141 Premstaetten, Austria

Phone +43 3136 500-0

[ams-osram.com](http://ams-osram.com)

© All rights reserved



## X-ON Electronics

Largest Supplier of Electrical and Electronic Components

*Click to view similar products for [High Power LEDs - Multi-Colour category](#):*

*Click to view products by [Osram manufacturer](#):*

Other Similar products are found below :

[LZP-00MD00-0000](#) [LZP-L0MD00-0000\\_G2](#) [LL-HP60MV1L](#) [LL-HP60NUYC](#) [OSB4XME3E1E](#) [OSG5XDE5E1E](#) [OSR5XAE1E1E](#)  
[OSR5XAE3E1E](#) [OSR5XME1E1E](#) [OSY5XAE1E1E](#) [OSY5XDE5E1E](#) [PK2N-3LGE-SD](#) [PK2N-3LRE-SD](#) [PQ2A-4FGE](#) [OSTCXBEAC1E](#)  
[LZP-W0MD00-0000](#) [PM2E-1LAS](#) [PM2E-1LGS](#) [PM2E-3LAE-SD](#) [PM2E-3LAS-SD](#) [PM2E-3LBS-SD](#) [PM2E-3LGS-SD](#) [PM2E-3LRE-SD](#)  
[PM2E-3LRS-SD](#) [PP6N-TFFE-D60](#) [PP6N-1LFE-P](#) [PK2N-3LLE-L](#) [OSG5XME1E1E](#) [OSR5XAT3C1E](#) [OSR5XME3E1E](#) [OSY5XME3E1E](#)  
[PC8N-5L4E-C](#) [PK2N-3LBE-SD](#) [PM2B-1LPE-M](#) [PM2B-1LPS-M](#) [PQ2A-4FRE](#) [CLQ6B-TKW-S1L1R1H1TBB7935CC3](#) [CLQ6B-TKW-](#)  
[S1L1R1H1TBB7935DD3](#) [CLQ6B-TKW-S1L1R1H1TBB7935BB3](#) [CLQ6B-TKW-S1L1R1H1TBB7935AA3](#) [CLW6A-TKW-](#)  
[C90C070B0BB7C3CE73](#) [CLW6A-TKW-C90C070B0BB7C3CE53](#) [CLW6A-TKW-C90C070B0BB7C3CP53](#) [CLW6A-TKW-](#)  
[C90C070B0BB7C3C523](#) [CLW6A-TKW-C90C070B0BB7C3CP33](#) [CLW6A-TKW-C90C070B0BB7C3CE83](#) [XMLDCL-00-R250-](#)  
[00C5AAA02](#) [XMLDCL-00-R250-00C4AAAE5](#) [XMLDCL-00-R250-00C3AAAE7](#) [XMLDCL-00-0000-00C4AAAB1](#)